

COLLECTION 2020

Poliform

Poliform

Poliform presenta la collezione 2020. Una serie di proposte per il living e la zona pranzo che fotografa nuove esperienze dell'abitare. Dalla continua ricerca di soluzioni e stili nascono così prodotti funzionali, esteticamente coerenti seppure disegnati da mani diverse, curati nelle forme e magistrali nelle lavorazioni, realizzati con materiali d'eccellenza. Per zone giorno in linea con le tendenze più attuali, tra design e comfort.

Poliform presents the 2020 collection. A series of products for the living and dining areas that picture new home experiences. From the continuous search for solutions and styles come functional products, aesthetically coherent even though they are designed by different hands, refined in the shapes and masterful in the details, made with excellent materials. For living areas in line with the most modern trends, between design and comfort.

2020

La zona giorno, oggi. Nel living, il divano è un sistema multifunzionale da creare liberamente, in base alle proprie preferenze. Si completa con poltrone dalle linee contemporanee e con tavolini. Nella zona pranzo i tavoli hanno dimensioni generose e spiccano per le finiture pregiate e la maestria delle lavorazioni. Trait d'union le madie e il tappeto, i cui motivi astratti si apprezzano sia accanto al divano sia sotto il tavolo da pranzo.

The day area, today. In the living, the sofa is a multifunctional system to be created freely, according to your preferences. It is complemented by armchairs with contemporary lines and by coffee tables. In the dining area the tables are generous in size and stand out for their fine finishes and masterful details. What brings everything together is the sideboards and the rug, whose abstract motifs are appreciated both next to the sofa and under the dining table.

COLLECTIONS

WESTSIDE SOFA	9
WESTSIDE COFFEE TABLE	49
NARA COFFEE TABLE	65
KAY LOUNGE ARMCHAIR	75
GENTLEMAN COLLECTION	93
CODE SIDEBOARD	119
MONDRIAN TABLE	145
HENRY TABLE	161
HOME HOTEL TABLE	177
SOPHIE LITE CHAIR AND STOOL	193
TRATTO CARPET	203
DATI TECNICI TECHNICAL DATA	209



WESTSIDE SOFA

Westside è un sistema multifunzionale che riscrive con eleganza l'esperienza della zona living. I moduli imbottiti si affiancano tra loro per creare le più diverse configurazioni – dall'isola bifacciale al classico divano angolare – mentre gli elementi come la chaise longue ergonomica, lo schienale mobile e i tavolini ne arricchiscono la funzionalità. Un archetipo di convivialità da vivere con la massima libertà.

Westside is a multifunctional system that elegantly rewrites the experience of the living area. The padded modules come together to create the most diverse configurations – from the two-face island to the classic corner sofa – while the elements such as the ergonomic chaise longue, the movable backrest, and the coffee tables enrich its functionality. An archetype of conviviality to be experienced with maximum freedom.







Qui, nelle pagine precedenti e nella successiva: divano Westside in tessuto sfoderabile Arcadia 02 sabbia, cuscini in velluto Tebe 06 giada, basamento in brown nickel opaco. Tavolini Westside, piano in marmo zecevo levigato e olmo nero, struttura in olmo nero e brown nickel opaco. Poltrona Kay Lounge in pelle non sfoderabile Hairy bianco/nero e struttura in cromo satinato. Madia Code in noce gold con top in laccato metallico bronzo, vano a giorno in laccato opaco bronzo e zoccolino in ardesia opaco. Mensolone Code retroilluminato in laccato semilucido granata. Tappeto Tratto carbone. A sinistra: dettaglio del cuscino schienale con poggiatesta in cuoio 26 invecchiato. Sotto: dettaglio del cuscino schienale con rullo.

This, previous pages and following page: Westside sofa in removable fabric Arcadia 02 sabbia, cushions in velvet Tebe 06 giada, base in mat brown nickel. Westside coffee tables, top in mat marble zecevo and black elm, structure in black elm and mat brown nickel. Kay Lounge armchair in non-removable Hairy leather white/black and structure in brushed chrome. Code sideboard in gold walnut with top in metal lacquer bronzo, open compartment in mat lacquer bronzo and plinth in mat ardesia. Code backlit thick shelf in granata semi-glossy lacquer. Carpet Tratto carbone. To the left: close up of the backrest cushion with headrest in hide 26 invecchiato. Below: close up of the backrest cushion with roll.





In questa pagina: pouf Westside con rivestimento sfoderabile in tessuto Arcadia 02 sabbia e schienale mobile in cuoio 26 invecchiato, basamento in brown nickel opaco.

This page: Westside pouf with non-removable cover in fabric Arcadia 02 sabbia, movable backrest in hide 26 invecchiato, base in mat brown nickel.

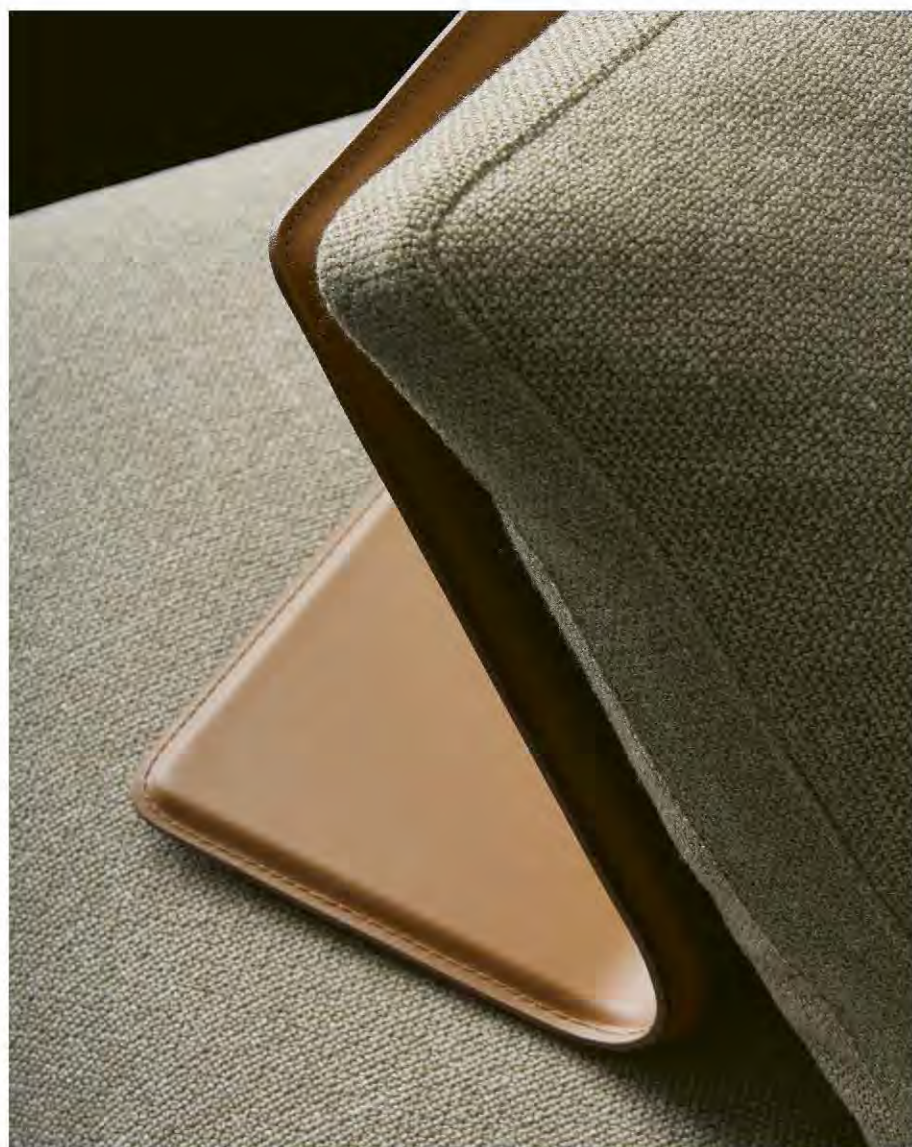



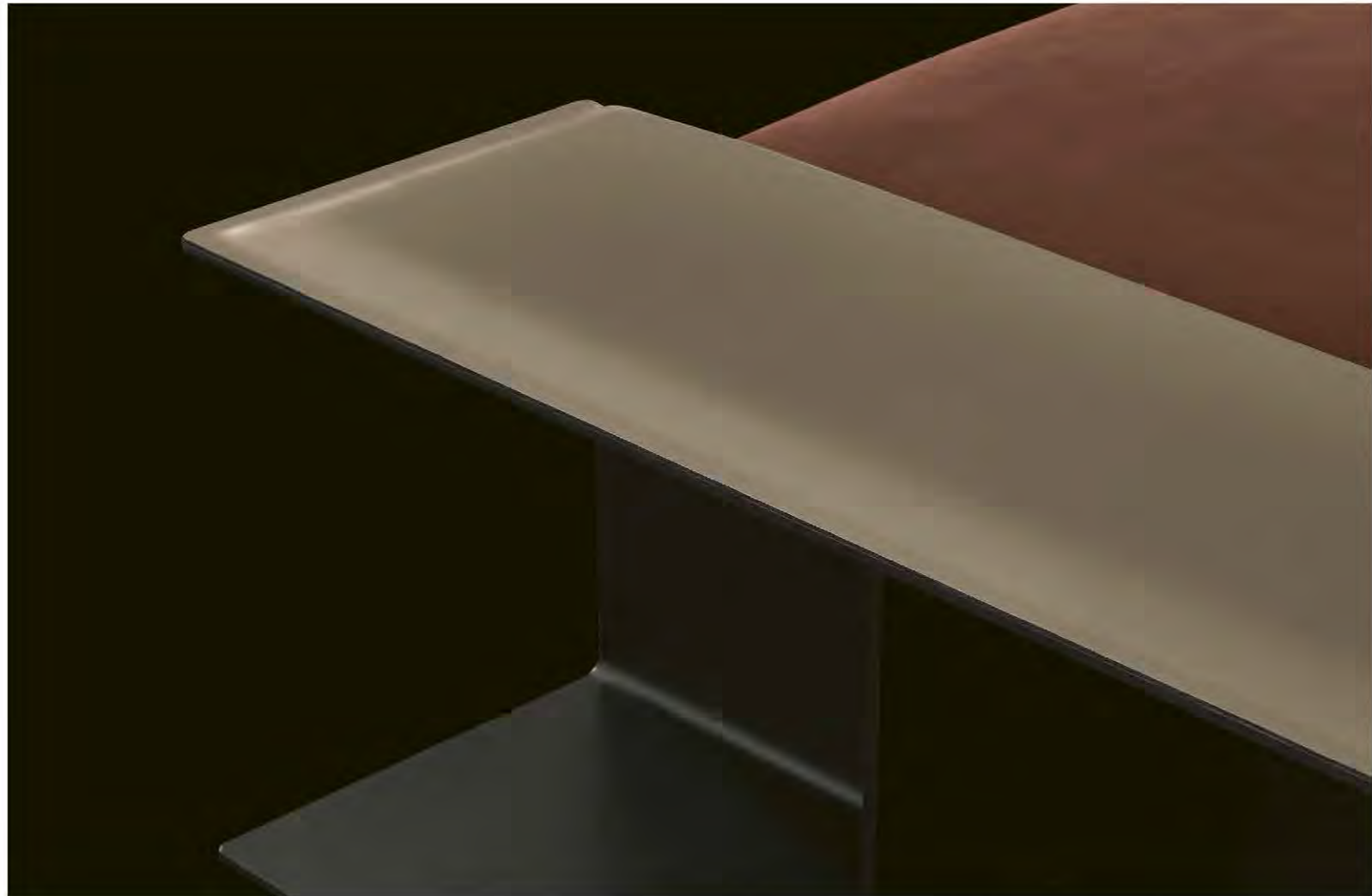

Qui e nella pagina precedente: divano Westside con rivestimento sfoderabile in pelle Silk 10 terracotta, cuscini in tessuto Lero 01 écru, basamento in brown nickel opaco. Elemento retro divano con mensola, esterno in cuoio 29 tortora, interno in brown nickel opaco.

This and previous page: Westside sofa with removable cover in leather Silk 10 terracotta, cushions in fabric Lero 01 ecru, base in mat brown nickel. Element behind the sofa with shelf, exterior in hide 29 tortora, interior in mat brown nickel.





Qui, nella pagina precedente e nella successiva: divano Westside in tessuto sfoderabile Arcadia 05 bronzo, cuscini in tessuto Siro 04 notte, basamento in brown nickel opaco. Tavolini Westside, piano in marmo sahara noir opaco finitura poliester e in olmo nero, struttura in olmo nero. Poltrona Kay Lounge in pelle non sfoderabile Silk 06 roccia e struttura in cromo satinato. Tavolino Nara in legno massello noce gold. Sistema Code con boiserie in tessuto lino chiaro e laccato opaco canapa con profili champagne opaco, mensole retroilluminate in laccato metallico ottone, contenitori sospesi retroilluminati in olmo nero e laccato metallico ottone con top in marmo zecevo levigato e vani a giorno laccato opaco ottone. Tappeto Plain tortora.

This, previous pages and following page: Westside sofa in removable fabric Arcadia 05 bronze, cushions in fabric Siro 04 notte, base in mat brown nickel. Westside coffee tables, top in mat marble sahara noir with polyester finish and in black elm, black elm structure. Kay Lounge armchair in non-removable leather Silk 06 roccia and brushed chrome structure. Nara coffee table in solid wood gold walnut. Code system with wall panelling in fabric lino chiaro and mat lacquer canapa with mat champagne profiles, backlit shelves in metal lacquer ottone, backlit suspended storage units in black elm and metal lacquer ottone with top in mat marble zecevo and mat lacquered ottone open compartments. Carpet Plain tortora.





In questa pagina: divano Westside in tessuto sfoderabile Arcadia 05 bronzo, cuscini schienale con rullo, basamento in brown nickel opaco. A sinistra: dettaglio del tavolino retro divano in olmo nero con cassetti laccato opaco roccia. Sotto: dettaglio dell'elemento retro divano con mensola, esterno in cuoio 29 tortora, interno in brown nickel opaco.

This page: Westside sofa in removable fabric Arcadia 05 bronzo, back-rest cushions with roll, base in mat brown nickel. To the left: close up of the back sofa coffee table in black elm with roccia mat lacquered drawers. Below: close up of the back sofa element with shelf, exterior in hide 29 tortora, interior in mat brown nickel.





In questa pagina: chaise longue Westside con rivestimento sfoderabile in tessuto Arcadia 05 bronzo, schienale in cuoio 29 tortora e brown nickel opaco, basamento in brown nickel opaco.

This page: Westside chaise longue with removable cover in fabric Arcadia 05 bronzo, backrest in hide 29 tortora and mat brown nickel, base in mat brown nickel.



WESTSIDE SOFA







Qui e nella pagina precedente: divano Westside con rivestimento sfoderabile in tessuto Antea 04 canapa, cuscini in velluto Persia 1404 carbone, basamento in brown nickel opaco. A sinistra: dettaglio dello schienale con mensola, esterno in cuoio 29 tortora, interno in brown nickel opaco. Sotto: dettaglio del bracciolo Slim, esterno in cuoio 29 tortora, interno in brown nickel opaco. Nella pagina successiva: tavolino retro divano in olmo nero con cassetti laccato opaco roccia. Elemento retro divano con mensola, esterno in cuoio 29 tortora interno in brown nickel opaco.

This and previous pages: Westside sofa with removable cover in fabric Antea 04 canapa, cushions in velvet Persia 1404 carbone, base in mat brown nickel. To the left: close up of the backrest with shelf, exterior in hide 29 tortora, interior in mat brown nickel. Below: close up of the armrest Slim, exterior in hide 29 tortora, interior in mat brown nickel. Following page: back sofa coffee table in black elm with roccia mat lacquered drawers. Back sofa element with shelf, exterior in hide 29 tortora, interior in mat brown nickel.





WESTSIDE

Design Jean-Marie Massaud, 2019

Struttura in legno e derivati. Cuscino schienale e seduta in poliuretano espanso a quote differenziate, rullo in poliuretano espanso, priverivestimento in tela cotone e piuma. Cuscini opzionali in tela cotone e piuma. Basamento verniciato brown nickel opaco. Rivestimento sfoderabile in tessuto o pelle. Giunta verticale nella fascia perimetrale della seduta, per la versione in tessuto posizionata al centro, per la versione in pelle su tutti gli angoli. Bracciolo Slim, schienale chaise longue, schienale con mensola ed elementi retro divano con struttura in alluminio verniciato brown nickel opaco, rivestiti all'esterno in cuoio colori. Poggiatesta e schienale mobile con struttura in metallo rivestito in cuoio colori. Tavolini retro divano con struttura in olmo nero e cassetto opzionale in laccato opaco colori, laccato lucido colori o laccato metallico ottone, bronzo o titanio.

Regola compositiva

Per la progettazione di una composizione bifacciale partire da una combinazione lineare, successivamente accostare gli elementi posteriormente e/o lateralmente.

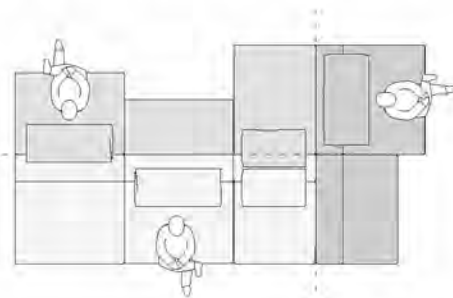

Esempi di accostamenti bifacciali

Il bracciolo non può avere funzione di schienale (1). Gli schienali non sono allineabili con sedute su lato opposto (2).

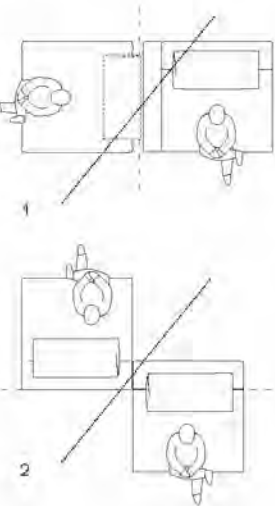

Structure in wood and wood-based products. Backrest cushion and seat in differentiated-density polyurethane foam, roll cushion in expanded polyurethane, pre-cover in cotton canvas and feather. Optional cushions in cotton canvas and feather. Base painted in mat brown nickel. Removable cover in fabric or leather. Vertical stitching in the perimeter band of the seating cushion, for the version in fabric it is positioned in the middle, for the version in leather on all the corners. Armrest Slim, chaise longue backrest, backrest with shelf and back sofa elements with structure in mat painted brown nickel aluminium, covered in hide on the outside. Headrest and movable backrest with structure covered in hide in the sample colours. Back sofa coffee tables with black elm structure and optional drawer in mat lacquered colours, glossy lacquered colours or metal lacquered ottone, bronzo or titanio.

Composition rule

To design a double-sided composition always start from a linear combination, then add the units to the back or to the side of the sofa.

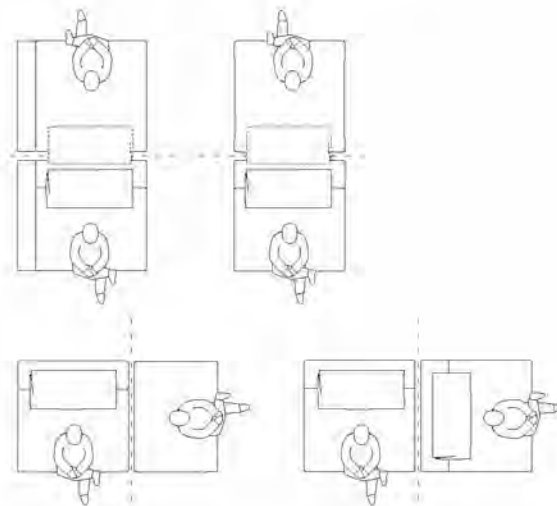

Examples of double-sided solutions

The arm cannot be used as a backrest (1). If the seat cushions are on the opposite side the backrests are not aligned (2).

Tipologie bracciolo Arm types



bracciolo I 200 h 580
arm w 7 3/4" h 22 3/4"



bracciolo Slim I 200 h 430
Slim arm w 7 3/4" h 17"



senza bracciolo
without arm

Tipologie cuscino Cushion types



cuscino schienale
backrest cushion



cuscino schienale con rullo
backrest cushion with roll cushion



cuscino schienale con poggiatesta
backrest cushion with headrest

Tipologie cuscino versione bifacciale Cushion types for double-sided version



opzione 1
option 1



opzione 2
option 2



opzione 3
option 3



opzione 4
option 4

Tipologia componenti
Components typology

Terminale
End unit

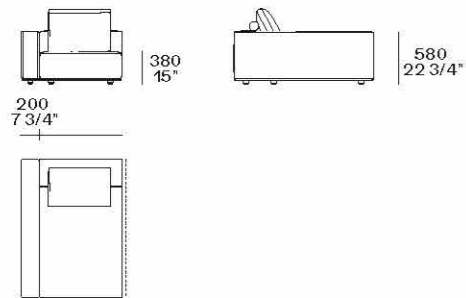

Terminale con bracciolo Slim
End unit with Slim arm

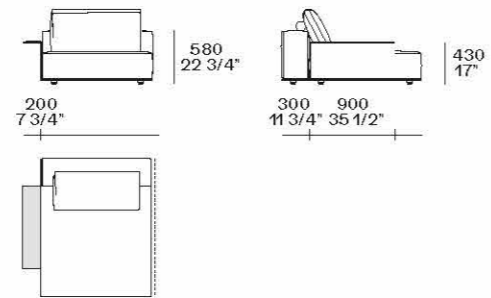

Chaise longue
Chaise longue

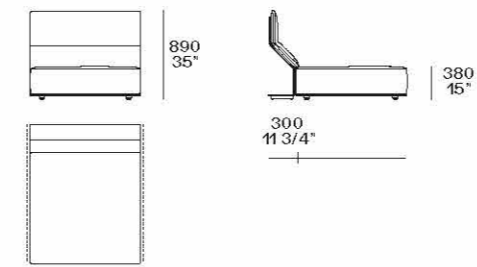

Chaise longue con bracciolo Slim
Chaise longue with Slim arm

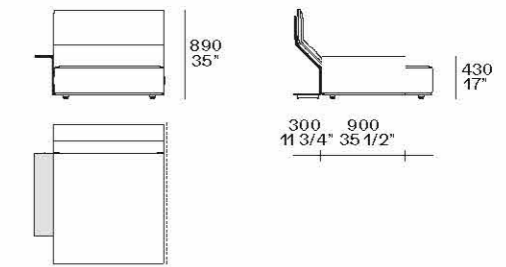

Terminale isola
Island end unit

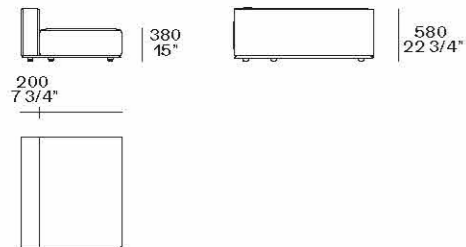

Pouf
Pouf

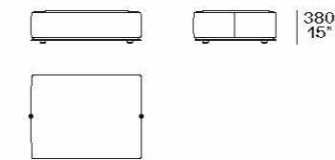

Angolo sx-dx
Lt-rt corner

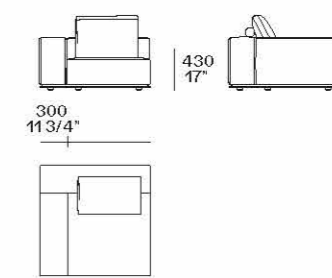

Centrale
Central unit

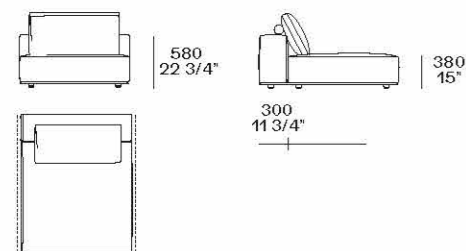

Centrale con schienale con mensola
Central unit with backrest with shelf

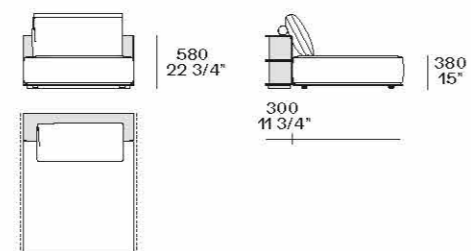

Elemento retro divano con mensola
Behind sofa element with shelf



Elemento retro divano con vano a giorno
Behind sofa element with open compartment

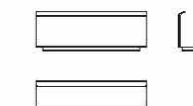

Tavolino retro divano
Behind sofa coffee table

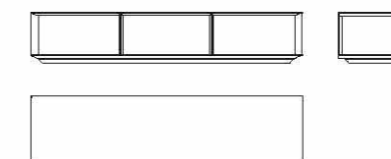

Modularità componenti
Components modularity

Terminale sx-dx
Lt-rt end unit

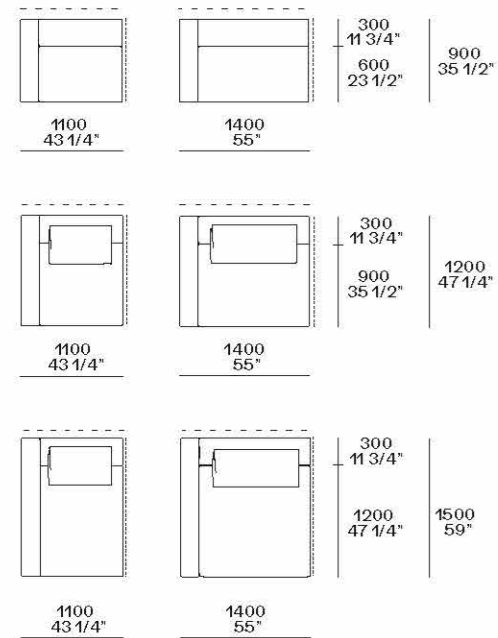

Centrale
Central unit

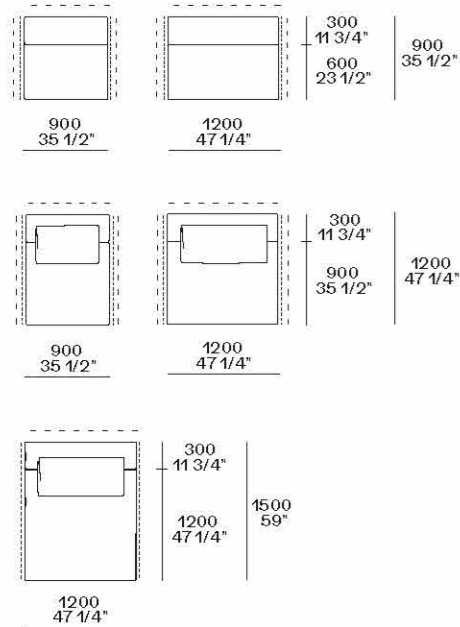

componibilità bifacciale
double-sided modularity

componibilità lineare
linear modularity

Posizionamento giunta verticale, nella fascia perimetrale dei pouf, per la versione in tessuto.
Positioning of the vertical stitching in the perimeter band of the poufs, for the fabric version.

Terminale sx-dx con bracciolo Slim
Lt-rt end unit with Slim arm

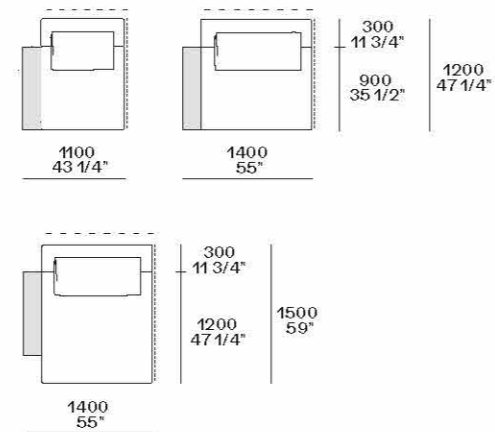

Terminale isola sx-dx
Lt-rt island end unit

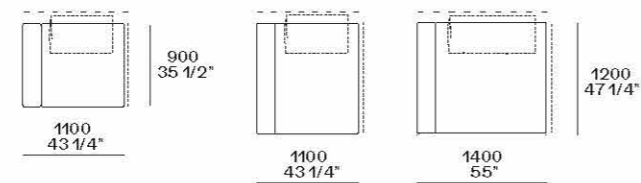

Nelle composizioni bifacciali i cuscini schienale sono appoggiati allo schienale dell'elemento retrostante.
In the double-sided compositions the backrest cushions rest on the backrest of the element behind.

Centrale con schienale con mensola
Central unit with backrest with shelf

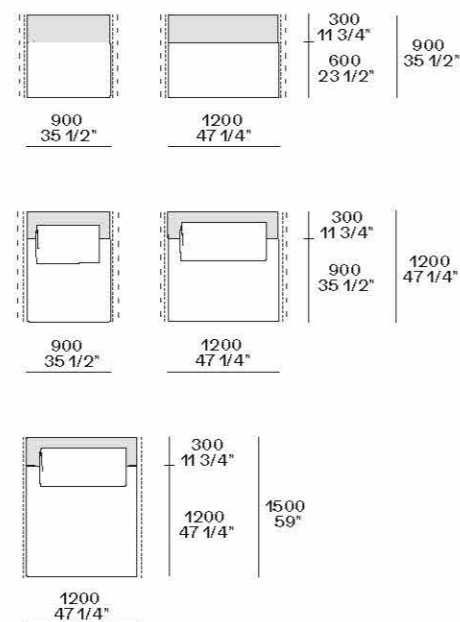

Chaise longue
Chaise longue

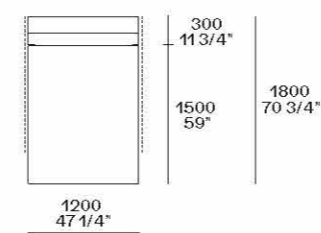
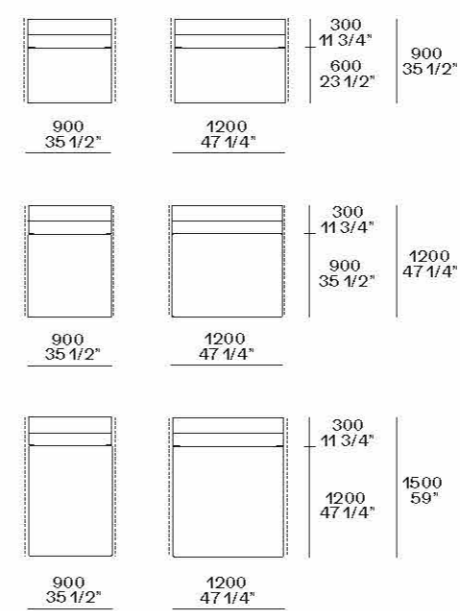

Pouf
Pouf

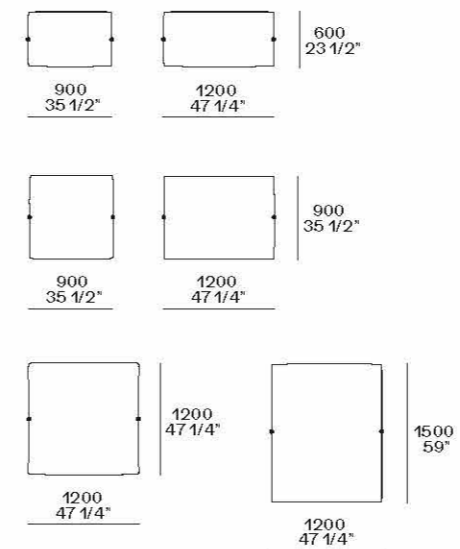

Usa terminale, centrale, angolare e bifacciale su tutti i lati tranne che per il modulo 1200x600 componibile in bifacciale solo su lato lungo.
Terminal, central, corner and double-sided use on all sides except for the 1200x600 module, which is double-sided modular only on the long side.

Chaise longue sx-dx con bracciolo Slim
Lt-rt chaise longue with Slim arm

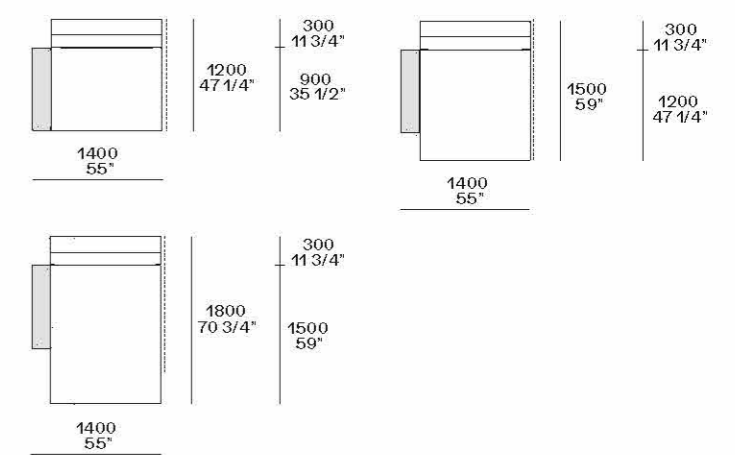

Angolo sx-dx
Lt-rt corner

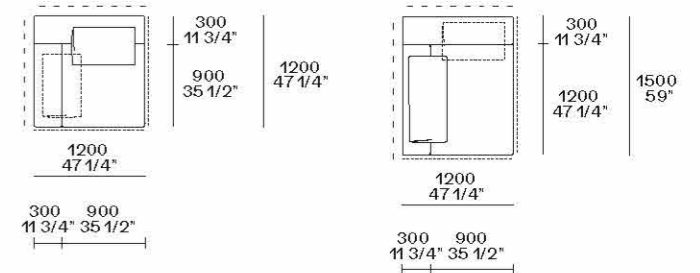

Cuscini schienale con o senza rullo Ø 90
Backrest cushions with or without roll cushion Ø 90

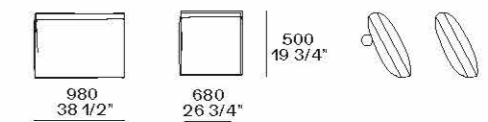

Larghezza 680-980 da abbinare in base alla larghezza degli schienali.
Width 680-980 to match according to the width of the backrests.

Poggiatesta
Headrest

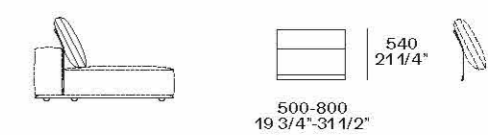

Non utilizzabile su pouf, chaise longue, elemento con mensola.
Not to be used on pouf, chaise longue, element with shelf.

Modularità componenti
Components modularity

Elemento retro divano con mensola
Behind sofa element with shelf

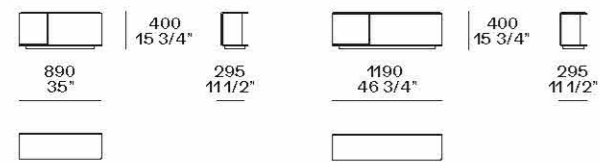

Elemento retro divano con vano a giorno
Behind sofa element with open compartment

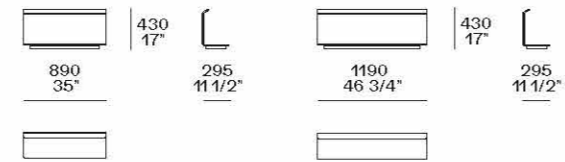

Tavolino retro divano
Behind sofa coffee table

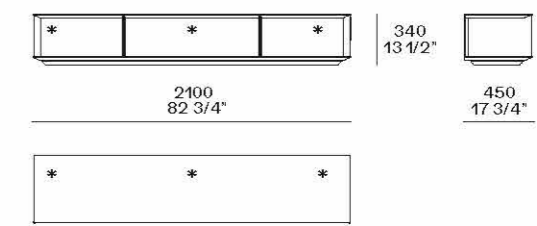
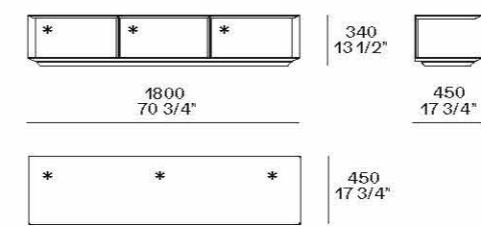

Schienale mobile
Movable backrest

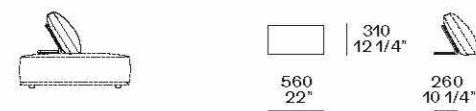

Utilizzabile solo su pouf.
To be used only on pouf.

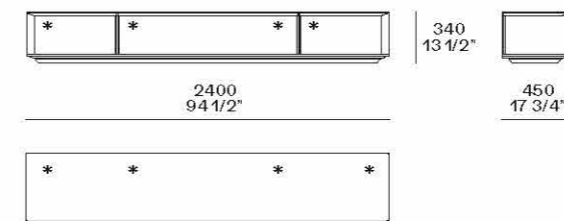

Cuscini opzionali comfort
Optional comfort cushions

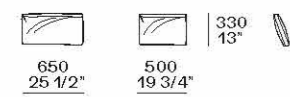

Cuscino opzionale a fascia
Optional band cushion

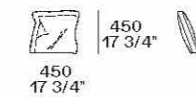

Cassetto opzionale *
Optional drawer *

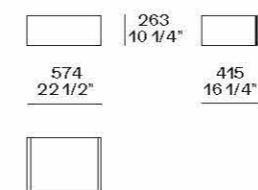



WESTSIDE COFFEE TABLE

Un raffinato equilibrio tra materiali e forme contraddistingue i tavolini della collezione Westside, che completano l'omonimo sistema di divani. Tre le versioni, disponibili in diverse finiture: il tavolino con cassetto o vano a giorno, il tavolino con base a incrocio in metallo e quello da accostare al divano.

A refined balance between materials and shapes characterizes the coffee tables of the Westside collection, which complete the homonymous system of sofas. There are three versions, available in different finishes: the coffee table with drawer or open compartment, the coffee table with crossed metal base, and the one to place next to the sofa.





Nella pagina precedente: tavolini Westside, quadrato con piano superiore in marmo zecevo levigato e rettangolare con piano superiore in olmo nero, struttura in olmo nero. Divano Westside in tessuto sfoderabile Arcadia O2 sabbia, cuscini in velluto Tebe O6 giada, basamento brown nickel opaco. Poltrona Kay Lounge in pelle non sfoderabile Hairy bianco/nero e struttura in cromo satinato. Madia Code in noce gold con top in laccato metallico bronzo, vano a giorno in laccato opaco bronzo e zoccolino in ardesia opaco. Mensolone Code retroilluminato in laccato semilucido granata. Tappeto Tratto carbone. A sinistra: tavolino Westside con piano in marmo zecevo levigato e struttura in brown nickel opaco. Sotto: dettaglio del tavolino Westside rettangolare con piano superiore e struttura in olmo nero.

Previous page: Westside coffee tables, square with top in mat marble zecevo and rectangular with top in black elm, structure in black elm. Westside sofa in removable fabric Arcadia O2 sabbia, cushions in velvet Tebe O6 giada, mat brown nickel base. Kay Lounge armchair in non-removable Hairy leather white/black and structure in brushed chrome. Code sideboard in gold walnut with top in metal lacquer bronzo, open compartment in mat lacquer bronzo and plinth in mat ardesia. Code backlit thick shelf in semi-glossy lacquer granata. Carpet Tratto carbone. To the left: Westside coffee table with top in mat marble zecevo and structure in mat brown nickel. Below: close up of the rectangular Westside coffee table with top and structure in black elm.



In questa pagina: tavolino Westside con piano in marmo sahara noir lucido finitura poliestere e struttura in champagne opaco. Nella successiva: tavolino Westside con piano e struttura in olmo nero, attrezzato con cassetto in laccato metallico bronzo. Tavolini con struttura in metallo finitura in brown nickel opaco con piano in olmo nero, in champagne opaco con piano in marmo sahara noir lucido finitura poliestere.

This page: Westside coffee table with top in glossy marble sahara noir with polyester finish and structure in mat champagne. Following page: Westside coffee table with top and structure in black elm, accessorized with drawer in metal lacquer bronzo. Coffee tables with structure in metal in mat brown nickel finish with black elm top, in mat champagne with top in glossy marble sahara noir with polyester finish.



WESTSIDE COFFEE TABLE





In questa pagina: tavolino Westside rettangolare con piano superiore in marmo zecevo levigato e struttura in olmo nero.

This page: rectangular Westside coffee table with top in mat marble zecevo and black elm structure.



In questa pagina: tavolini Westside con piano superiore in marmo sahara noir opaco finitura poliestere e in olmo nero, struttura in olmo nero. Divano Westside in tessuto sfoderabile Arcadia 05 bronzo, cuscini in tessuto Siro 04 notte, basamento in brown nickel opaco. Poltrona Kay Lounge in pelle non sfoderabile Silk 06 roccia e struttura in cromo satinato. Tavolino Nara in legno massello noce gold. Sistema Code con boiserie in tessuto lino chiaro e laccato opaco canapa, mensole retroilluminate in laccato metallico ottone e mensolone in olmo nero, contenitori in olmo nero e laccato metallico ottone con top in marmo zecevo levigato. Tappeto Plain tortora. Nella successiva: tavolini Westside con piano superiore in marmo zecevo levigato e in olmo nero, struttura in olmo nero. Tappeto Tratto carbone.

This page: Westside coffee tables with top in mat marble sahara noir with polyester finish and in black elm, black elm structure. Westside sofa in removable fabric Arcadia 05 bronzo, cushions in fabric Siro 04 notte, base in mat brown nickel. Kay Lounge armchair in non-removable leather Silk 06 roccia and structure in brushed chrome. Nara coffee table in solid wood gold walnut. Code system with wall paneling in fabric lino chiaro and mat lacquer canapa, backlit shelves in metal lacquer ottone and thick shelf in black elm, storage units in black elm and metal lacquer ottone with top in mat marble zecevo. Carpet Plain tortora. Following page: Westside coffee tables with top in mat marble zecevo and in black elm, structure in black elm. Carpet Tratto carbone.



WESTSIDE COFFEE TABLE





WESTSIDE

Design Jean-Marie Massaud, 2019

Tavolini con struttura in olmo nero. Piano in olmo nero, sei marmi levigati e sei lucidi. Cassetto opzionale per vani a giorno in laccato opaco colori, laccato lucido colori, laccato metallico ottone, bronzo o titanio. Tavolini con struttura in metallo verniciato brown nickel opaco o champagne opaco. Piano in olmo nero, sei marmi levigati e sei lucidi.

Coffee tables with structure in black elm. Top in black elm, six mat and six glossy marbles. Optional drawer for open compartment mat lacquered colours, glossy lacquered colours, metal lacquered ottone, bronzo or titanio. Coffee tables with structure in painted mat brown nickel or mat champagne metal. Top in black elm, six mat and six glossy marbles.

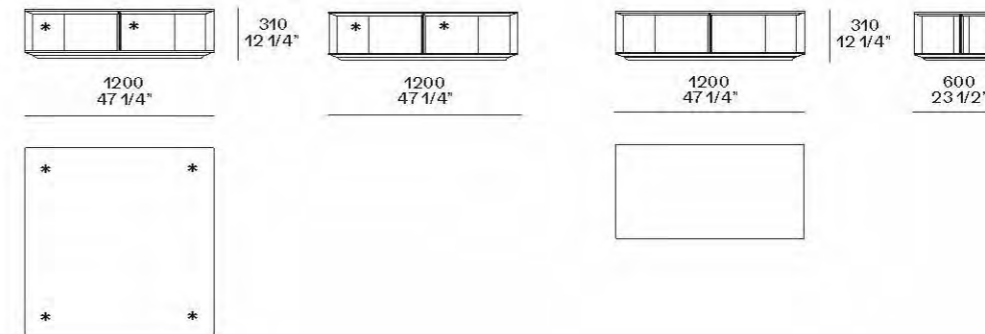

Cassetto opzionale *

Optional drawer *

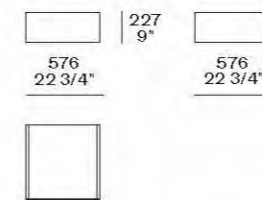

Disponibile solo per tavolino 1200x1200 con piano in olmo nero.
Available only for coffee table 1200x1200 in the version with black elm top.

Tavolini metallo

Metal coffee tables

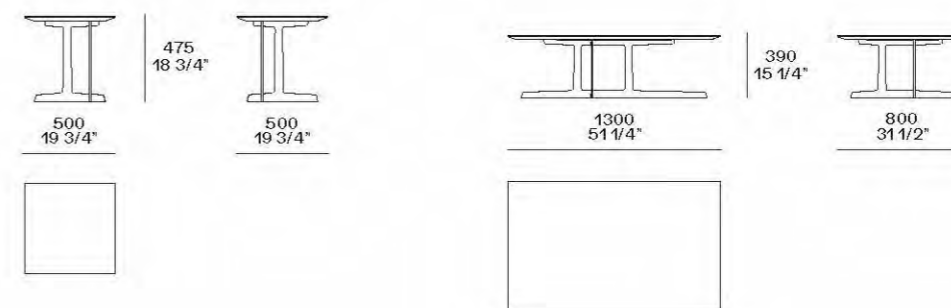



NARA

Tavolino o sgabello, pouf o comodino: Nara è un complemento trasversale, ideale nei più diversi contesti. Disegnato da Jean-Marie Massaud, è realizzato in legno massello e caratterizzato dalla base lavorata.

Coffee table or stool, footstool or bedside table: Nara is a universal complement, ideal in the most diverse contexts. Designed by Jean-Marie Massaud, it is made of solid wood and characterized by an elaborate base.



Qui e nella pagina precedente: tavolini Nara, piano e struttura in legno massello noce gold. Divano Westside, rivestimento sfoderabile in tessuto Arcadia 02 sabbia, cuscini in velluto Tebe 06 giada, schienale mobile in cuoio 26 invecchiato, basamento in brown nickel opaco. Tappeto Tratto carbone.

This and previous page: Nara coffee tables, top and structure in solid wood gold walnut. Westside sofa, removable cover in fabric Arcadia 02 sabbia, cushions in velvet Tebe 06 giada, movable backrest in hide 26 invecchiato, mat brown nickel base. Carpet Tratto carbone.





In questa pagina: tavolini Nara, piano e struttura in legno massello tinto olmo nero. Nella pagina successiva: tavolini Nara in legno massello tinto olmo nero. Letto Jacqueline, testata e base imbottite con rivestimento sfoderabile in tessuto Lima 67 pernice e cuciture a cordoncino in colore nero, rulli in pelle sfoderabile Silk 10 terracotta, biancheria da letto coordinata in cotone Provence 01 bianco e 08 polvere con profili nero. Tappeto Plain natural.

This page: Nara coffee tables, top and structure in solid wood stained black elm. Following page: Nara coffee table in solid wood stained black elm. Jacqueline bed, padded headboard and base with removable cover in fabric Lima 67 pernice and drawstring stitchings in black colour, roll cushions in removable leather Silk 10 terracotta, coordinated bed linen in cotton Provence 01 bianco and 08 polvere with black profiles. Carpet Plain natural.





NARA

Design Jean-Marie Massaud, 2019

Struttura e piano in legno massello
noce gold o tinto olmo nero.

Structure and top in solid wood gold
walnut or stained black elm.

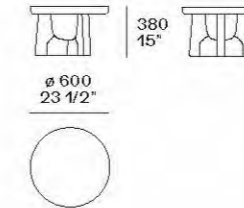
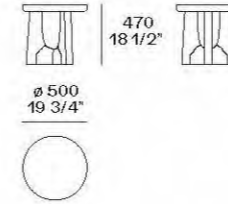



KAY LOUNGE

Elegante, leggera ed essenziale, Kay Lounge è una poltrona dall'innata modernità. La struttura è in metallo, mentre la seduta è disponibile in pelle o cuoio. Da sola o in coppia, con il caratteristico poggiatesta, Kay Lounge è una poltrona che si fa notare in ogni contesto, dal più classico al più contemporaneo.

Elegant, light, and minimalistic, Kay Lounge is an armchair with an innate modernity. The structure is in metal, while the seat is available in leather or hide. Alone or paired, with the characteristic footrest, Kay Lounge is an armchair that stands out in every context, from the most classic to the most contemporary.





Qui e nella pagina precedente: poltrona e pouf Kay Lounge in pelle non sfoderabile Hairy bianco/nero, struttura in cromo satinato. Tavolino Nara in legno massello noce gold. Mensolone Code retroilluminato in laccato semilucido granata. Divano Westside in tessuto sfoderabile Arcadia 02 sabbia, cuscini in velluto Tebe 06 giada, schienale mobile in cuoio 26 invecchiato e basamento in brown nickel opaco. Tappeto Tratto carbone.

This and previous page: Kay Lounge armchair and pouf in non-removable leather Hairy white/black, structure in brushed chrome. Nara coffee table in solid wood gold walnut. Code backlit thick shelf in semi-glossy lacquer granata. Westside sofa in removable fabric Arcadia 02 sabbia, cushions in velvet Tebe 06 giada, movable backrest in hide 26 invecchiato and mat brown nickel base. Carpet Tratto carbone.



In questa pagina: poltrona e pouf Kay Lounge, rivestimento non sfoderabile in pelle Silk 12 senape e struttura in cromo satinato.

This page: Kay Lounge armchair and pouf, non-removable cover in leather Silk 12 senape and brushed chrome structure.





In questa pagina: poltrona e pouf Kay Lounge, rivestimento non sfoderabile in cuoio intrecciato O2 nero, struttura in brown nickel opaco.

This page: Kay Lounge armchair and pouf, non-removable cover in woven hide O2 nero, mat brown nickel structure.





In questa pagina: poltrona e pouf Kay Lounge, rivestimento non sfoderabile in pelle Silk 06 roccia e struttura in cromo satinato. Sistema Code con boiserie in tessuto lino chiaro e laccato opaco canapa con profili champagne opaco, contenitori sospesi retroilluminati in laccato metallico ottone con top in marmo zecevo levigato. Tappeto Plain tortora.

This page: Kay Lounge armchair and pouf, non-removable cover in leather Silk 06 roccia and structure in brushed chrome. Code system with wall panelling in fabric lino chiaro and mat lacquer canapa with mat champagne profiles, backlit suspended storage units in metal lacquer ottone with top in mat marble zecevo. Carpet Plain tortora.





In questa pagina: poltrona Kay Lounge, rivestimento non sfoderabile in cuoio 02 nero e struttura in cromo satinato.

This page: Kay Lounge armchair, non-removable cover in hide 02 nero and brushed chrome structure.



Qui e nella pagina successiva: poltrona e pouf Kay Lounge, rivestimento non sfoderabile in pelle Hairy cappuccino, struttura in brown nickel opaco. Tavolino Dama in legno massello noce canaletto. Letto Jacqueline, testata e base imbottite con rivestimento sfoderabile in tessuto Lima 67 pernice e cuciture a cordoncino in colore nero, rulli in pelle sfoderabile Silk 10 terracotta, biancheria da letto coordinata in cotone Provence 01 bianco e 08 polvere con profili nero. Tappeto Plain natural.

This and following page: Kay Lounge armchair and pouf, non-removable cover in leather Hairy cappuccino, mat brown nickel structure. Dama coffee table in solid wood walnut Canaletto. Jacqueline bed, padded headboard and base with removable cover in fabric Lima 67 pernice and drawstring stitchings in black colour, roll cushions in removable leather Silk 10 terracotta, coordinated bed linen in cotton Provence 01 bianco and 08 polvere with black profiles. Carpet Plain natural.





KAY LOUNGE

Design Jean-Marie Massaud, 2019

Struttura in metallo, finitura cromo satinato o verniciato brown nickel opaco.
 Seduta e schienale in poliuretano flessibile stampato o cinghie elastiche solo per la versione in cuoio intrecciato.
 Rivestimento non sfoderabile in pelle, pelle Hairy, cuoio colori o cuoio intrecciato colori.

Structure in metal, finish brushed chrome or painted mat brown nickel.
 Seat and backrest in flexible moulded polyurethane or elastic belts only for the version in woven hide.
 Non-removable cover in leather, hairy leather, hide or woven hide in the sample colours.

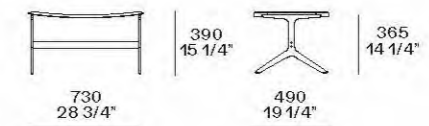
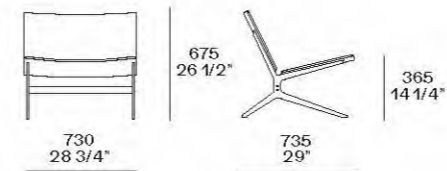



GENTLEMAN COLLECTION

Disegnata da Marcel Wanders, la collezione Gentleman è composta da divano fisso, pouf e tre poltrone di diverse dimensioni – compatta Gentleman Single, morbida e accogliente Gentleman Relax, fuori del comune Gentleman Reserved, con schienale alto. Una collezione di sedute dal comfort ineguagliabile, da usare singolarmente o tutte insieme.

Designed by Marcel Wanders, the Gentleman collection consists of a fixed sofa, ottoman, and three armchairs of different sizes – compact Gentleman Single, soft and cosy Gentleman Relax, outside-the-box Gentleman Reserved, with a tall backrest. A collection of seats with unparalleled comfort, to be used individually or all together.





Nelle pagine precedenti: poltrone Gentleman Relax e pouf Gentleman in tessuto sfoderabile Siro 02 lino, divano Gentleman's Friends in velluto sfoderabile Tebe 08 notte, basamento in brown nickel lucido. Pouf New York in velluto sfoderabile Tebe 08 notte. Tavolini Soori in metallo finitura bronzo anticato. Madia Code in noce gold, vano a giorno in laccato opaco champagne con schienale in specchio bronzo e luce a led integrata, basamento con piedini in champagne opaco. Sistema Code, mensolone in laccato metallico ottone, boiserie in laccato opaco canapa, vani a giorno in laccato opaco ottone con schienali in noce gold. Tappeto Plain tortora. In questa pagina: poltrona Gentleman Single in pelle sfoderabile Silk 12 senape con basamento in brown nickel lucido.

Previous pages: Gentleman Relax armchairs and Gentleman pouf in removable fabric Siro 02 lino, Gentleman's Friends sofa in removable velvet Tebe 08 notte. Soori coffee tables in metal with antique bronze finish. Code sideboard in gold walnut, open compartment in mat lacquer champagne with back in bronzed mirror and integrated led light, base with feet in mat champagne. Code system, thick shelf in metal lacquer ottone, wall panelling in mat lacquer canapa, and open compartments in mat lacquer ottone with backs in gold walnut. Carpet Plain tortora. This page: Gentleman Single armchair in removable leather Silk 12 senape with base in glossy brown nickel.



GENTLEMAN SINGLE







Nella pagina precedente: divano Gentleman's Friends, rivestimento in tessuto sfoderabile Arcadia 05 bronzo, cuscini in velluto Persia 1404 carbone con bordura gros-grain acciaio, basamento in brown nickel lucido. In questa pagina: poltrona Gentleman Reserved, rivestimento sfoderabile, esterno in pelle Nabuk 02 tortora e interno in tessuto Micene 03 sabbia, cuscino poggiatesta e bottoni in pelle Nabuk 02 tortora, basamento in brown nickel lucido. Pouf Gentleman, rivestimento sfoderabile in tessuto Micene 03 sabbia e pelle Nabuk 02 tortora, basamento in brown nickel lucido.

Previous page: Gentleman's Friends sofa, cover in removable fabric Arcadia 05 bronzo, cushions in velvet Persia 1404 carbone with gros-grain piping acciaio, glossy brown nickel base. This page: Gentleman Reserved armchair, removable cover, exterior in leather Nabuk 02 tortora and interior in fabric Micene 03 sabbia, lower back cushion and buttons in leather Nabuk 02 tortora, base in glossy brown nickel. Gentleman pouf, removable cover in fabric Micene 03 sabbia and leather Nabuk 02 tortora, glossy brown nickel base.





In questa pagina: poltrone Gentleman Relax e pouf Gentleman in tessuto sfoderabile Siro 02 lino, divano Gentleman's Friends in velluto sfoderabile Tebe 08 notte, basamento in brown nickel lucido. Tavolini Soori in metallo finitura bronzo anticato. Sistema Code, mensolone retroilluminato in laccato metallico ottone, boiserie in laccato opaco canapa con profili champagne opaco, vani a giorno in laccato opaco ottone con schienali in noce gold. Tappeto Plain tortora.

This page: Gentleman Relax armchairs and Gentleman pouf in removable fabric Siro 02 lino, Gentleman's Friends sofa in removable velvet Tebe 08 notte, glossy brown nickel base. Soori coffee tables in metal with antique bronze finish. Code system, backlit thick shelf in metal lacquer ottone, wall panelling in mat lacquer canapa with mat champagne profiles, open compartments in mat lacquer ottone with backs in gold walnut. Carpet Plain tortora.





In questa pagina: divano Gentleman's Friends, rivestimento sfoderabile in velluto Tebe 08 notte, basamento in brown nickel lucido. Tavolini Soori in metallo finitura bronzo anticato. Tappeto Plain tortora.

This page: Gentleman's Friends sofa, removable cover in velvet Tebe 08 notte, glossy brown nickel base. Soori coffee tables in metal with antique bronze finish. Carpet Plain tortora.



In questa pagina: poltrona Gentleman Relax e pouf Gentleman, rivestimento sfoderabile in pelle Soft 03 nocciola, basamento in brown nickel opaco.

This page: Gentleman Relax armchair and Gentleman pouf, cover in removable leather Soft 03 nocciola, mat brown nickel base.



GENTLEMAN RELAX





In questa pagina: poltrona Gentleman Relax, rivestimento sfoderabile in tessuto Antea 10 grafite con bordura gros-grain nero, basamento in champagne opaco.

This page: Gentleman Relax armchair, removable cover in fabric Antea 10 grafite with grosgrain piping nero, base in mat champagne.



In questa pagina: poltrona Gentleman Reserved e pouf Gentleman in pelle sfoderabile Silk 10 terracotta, basamento in champagne opaco. Armadio Senzafine Cover in vetro acidato bronzo e profili in ardesia opaco. Tappeto Plain natural.

This page: Gentleman Reserved armchair and Gentleman pouf in removable leather Silk 10 terracotta, base in mat champagne. Wardrobe Senzafine Cover in etched glass bronzo and profiles in mat ardesia. Carpet Plain natural.





In questa pagina: poltrona Gentleman Single in tessuto sfoderabile Kitami 04 sabbia con bordura gros-grain sahara e basamento in brown nickel lucido. Tavolino Dama in legno massello noce canaletto. Sistema Code con boiserie in tessuto lino chiaro e profili champagne opaco, contenitori sospesi in noce gold con top retroilluminato in marmo zecevo levigato. Mensolone retroilluminato in laccato semilucido visone e canalina con profili in champagne opaco. Letto Onda in pelle non sfoderabile Silk 10 terracotta con lavorazione capitonné e piedini in brown nickel opaco. Biancheria da letto coordinata in cotone Provence 04 tortora e 06 roccia.

This page: Gentleman Single armchair in removable fabric Kitami 04 sabbia with grosgrain piping sahara and glossy brown nickel base. Dama coffee table in solid wood walnut canaletto. Code system with wall panelling in fabric lino chiaro and mat champagne profiles, suspended storage units in gold walnut with backlit top in mat marble zecevo. Backlit thick shelf in semi-glossy lacquer visone and cable passage channel with mat champagne profiles. Onda bed in non-removable leather Silk 10 terracotta with capitonné manufacturing and mat brown nickel feet. Coordinated bed linen in cotton Provence 04 tortora and 06 roccia.



GENTLEMAN COLLECTION

Design Marcel Wanders, 2019

Gentleman Single

Scocca e seduta in poliuretano flessibile stampato con parti in poliuretano flessibile a quote differenziate. Prerivestimento in ovatta di poliestere. Basamento in alluminio verniciato champagne opaco, brown nickel opaco o lucido. Rivestimento sfoderabile in tessuto o pelle. Bordura gros-grain nei colori da campionario.

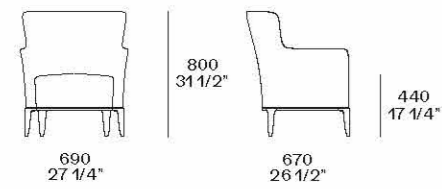

Body and seat in flexible moulded polyurethane with parts in differentiated-density flexible polyurethane. Pre-cover in polyester wadding. Base in painted aluminium mat champagne, mat or glossy brown nickel. Removable cover in fabric or leather. Grosgrain border in the sample colours.

Gentleman Relax

Scocca e seduta in poliuretano flessibile stampato con parti in poliuretano flessibile a quote differenziate. Prerivestimento in ovatta di poliestere. Basamento in alluminio verniciato champagne opaco, brown nickel opaco o lucido. Rivestimento sfoderabile in tessuto o pelle. Bordura gros-grain nei colori da campionario.

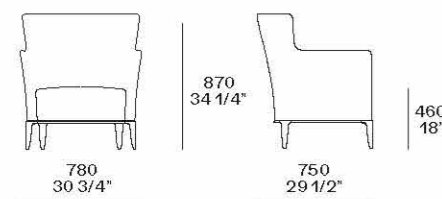

Body and seat in flexible moulded polyurethane with parts in differentiated-density flexible polyurethane. Pre-cover in polyester wadding. Base in painted aluminium mat champagne, mat or glossy brown nickel. Removable cover in fabric or leather. Grosgrain border in the sample colours.

Gentleman Pouf

Scocca e seduta in poliuretano flessibile stampato con parti in poliuretano flessibile a quote differenziate. Prerivestimento in ovatta di poliestere. Basamento in alluminio verniciato champagne opaco, brown nickel opaco o lucido. Rivestimento sfoderabile in tessuto o pelle. Possibilità di rivestimento diverso tra la seduta e la fascia perimetrale.

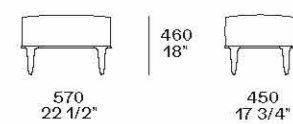

Body and seat in flexible moulded polyurethane with parts in differentiated-density flexible polyurethane. Pre-cover in polyester wadding. Base in painted aluminium mat champagne, mat or glossy brown nickel. Removable cover in fabric or leather. Possibility of different cover for seat cushion and perimeter band.

Gentleman Reserved

Scocca e seduta in poliuretano flessibile stampato con parti in poliuretano flessibile a quote differenziate. Prerivestimento in ovatta di poliestere. Basamento in alluminio verniciato champagne opaco, brown nickel opaco o lucido. Rivestimento sfoderabile in tessuto o pelle. Bordura gros-grain nei colori da campionario. Possibilità di rivestimento diverso tra interno ed esterno della scocca con bottoni previsti nella stessa finitura (rivestimento esterno o interno). Cuscino salvareni opzionale con rivestimento sfoderabile in tessuto o pelle.

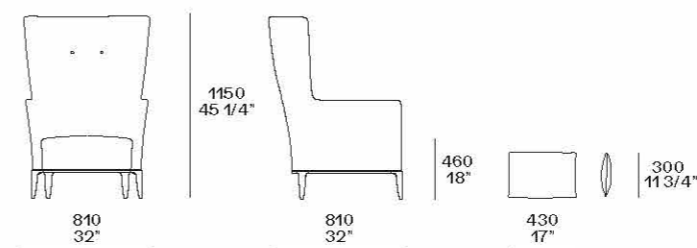

Body and seat in flexible moulded polyurethane with parts in differentiated-density flexible polyurethane. Pre-cover in polyester wadding. Base in painted aluminium mat champagne, mat or glossy brown nickel. Removable cover in fabric or leather. Grosgrain border in the sample colours. Possibility of different cover for inside and outside of the body with buttons in the same finish (internal or external cover). Optional lower back cushion with removable cover in fabric or leather.

cuscinò salvareni
kidneyrest cushion

Gentleman's Friends

Scocca e seduta in poliuretano flessibile stampato con parti in poliuretano flessibile a quote differenziate. Prerivestimento in ovatta di poliestere. Basamento in alluminio verniciato champagne opaco, brown nickel opaco o lucido. Rivestimento sfoderabile in tessuto o pelle. Bordura gros-grain nei colori da campionario.

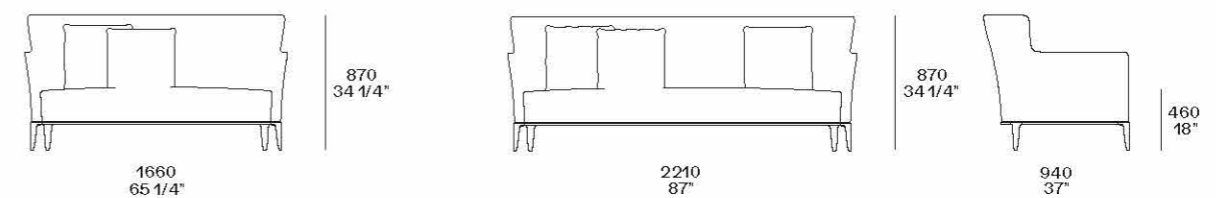

Body and seat in flexible moulded polyurethane with parts in differentiated-density flexible polyurethane. Pre-cover in polyester wadding. Base in painted aluminium mat champagne, mat or glossy brown nickel. Removable cover in fabric or leather. Grosgrain border in the sample colours.

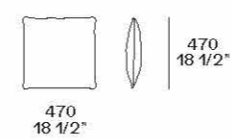

cuscinò
cushion



CODE SIDEBOARD

La collezione di madie Code completa l'omonimo sistema con una serie di contenitori disponibili in diverse configurazioni – con vani a giorno, cassetti e ante battenti o a ribalta. La versatilità del sistema si ritrova nella varietà di finiture, che danno a ogni madia uno stile diverso – più classico o più contemporaneo.

The Code sideboard collection completes the homonymous system with a series of containers available in different configurations – with open compartments, drawers, and hinged or folding doors. The versatility of the system can also be found in the variety of finishes, which give each sideboard a different style – more classic or more contemporary.



Qui e nella pagina precedente: madia Code in noce gold con top in laccato metallico bronzo, vano a giorno in laccato opaco bronzo, zoccolino in ardesia opaco. Mensolone Code sospeso retroilluminato in laccato semilucido granata. Poltrona Kay Lounge in pelle non sfoderabile Hairy bianco/nero, struttura in cromo satinato. Tavolini Nara in legno massello tinto olmo nero. Divano Westside in tessuto sfoderabile Arcadia 02 sabbia, cuscini in velluto Tebe 06 giada, basamento in brown nickel opaco. Tavolini Westside, piano in marmo zecevo levigato e olmo nero, struttura in olmo nero e brown nickel opaco. Tappeto Tratto carbone.

This and previous page: Code sideboard in gold walnut with top in metal lacquer bronzo, open compartment in mat lacquer bronzo, plinth in mat ardesia. Code backlit suspended thick shelf in semi-glossy lacquer granata. Kay Lounge armchair in non-removable leather Hairy white/black, structure in brushed chrome. Nara coffee tables in solid wood stained black elm. Westside sofa in removable fabric Arcadia 02 sabbia, cushions in velvet Tebe 06 giada, mat brown nickel base. Westside coffee tables, top in mat marble zecevo and black elm, structure in black elm and mat brown nickel. Carpet Tratto carbone.



CODE SIDEBOARD





Qui e nella pagina precedente: madia Code in olmo nero con top in marmo zecevo levigato e basamento con piedini ardesia opaco. Contenitori vetrina con luce a led integrata, ante in vetro trasparente riflettente, struttura interna in olmo nero con schienale in tessuto lino chiaro, ripiano in vetro trasparente. Vano a giorno con luce a led integrata, struttura interna in laccato opaco bronzo e schienali in olmo nero. Tavolo Henry in olmo nero con piano in marmo sahara noir levigato finitura poliester. Sedie Sophie in tessuto non sfoderabile Kitami O4 sabbia e struttura in olmo nero. Tappeto Tratto ruggine. Sotto: dettaglio del cassetto in laccato metallico bronzo, fondo in tecnopelle O6 nocciola con portaposate in ardesia opaco, piano superiore in laccato metallico bronzo.

This and previous page: Code sideboard in black elm with top in mat marble zecevo and base with feet mat ardesia. Display case storage units with integrated led light, doors in transparent glass, inner structure in black elm with back in fabric lino chiaro, shelf in transparent reflecting glass. Open compartment with integrated led light, inner structure in mat lacquer bronzo and backs in black elm. Henry table in black elm with top in mat marble sahara noir with polyester finish. Sophie chairs in non-removable fabric Kitami O4 sabbia and structure in black elm. Carpet Tratto ruggine. Below: close up of the drawer in metal lacquer bronzo, bottom in techno leather O6 nocciola with cutlery tray in mat ardesia, upper shelf in metal lacquer bronzo.



In questa pagina: madia Code in laccato metallico ottone con schienali in noce c. e struttura interna in laccato opaco ottone. Contenitori vetrina con luce a led integrata, ante in vetro trasparente riflettente con telaio e maniglia in ardesia opaco, ripiani in vetro trasparente, frontali cassetti in laccato metallico ottone. Vano a giorno con luce a led integrata, ripiani in laccato opaco ottone. Basamento con piedini ardesia opaco.

This page: Code sideboard in metal lacquer ottone with backs in walnut c. and inner structure in mat lacquer ottone. Display case storage units with integrated led light, doors in transparent reflecting glass with frame and handle in mat ardesia, shelves in transparent glass with frame and handle in mat ardesia, shelves in transparent glass, and drawer fronts in metal lacquer ottone. Open compartment with integrated led light, shelves in mat lacquer ottone. Base with feet in mat ardesia.





In questa pagina: madia Code in laccato metallico bronzo e basamento con piedini ardesia opaco. Vano a giorno con luce a led integrata, schienale in tessuto lino scuro e top interno in marmo sahara noir levigato finitura poliestere. Sotto: dettaglio del vassoio con fondo in tecnopelle 06 nocciola.

This page: Code sideboard in metal lacquer bronzo and base with feet in mat ardesia. Open compartment with integrated led light, back in fabric lino scuro and inner top shelf in mat marble sahara noir with polyester finish. Below: close up of the tray with bottom in techno leather 06 nocciola.



In questa pagina: madia Code in noce gold e basamento con piedini champagne opaco. Vano a giorno in laccato opaco champagne con schienale in specchio bronzo e luce a led integrata, top interno in marmo zecevo levigato. Contenitore con ante battenti, maniglia in champagne opaco, vassoio superiore con fondo in tecnopelle 06 nocciola. Poltrona Gentleman Relax in tessuto sfoderabile Siro 02 lino con basamento in brown nickel lucido. Tappeto Plain tortora.

This page: Code sideboard in gold walnut and base with mat champagne feet. Open compartment in mat lacquer champagne with back in bronzed mirror and integrated led light, inner top shelf in mat marble zecevo levigato. Storage unit with leaf doors, mat champagne handle, upper tray with bottom in techno leather 06 nocciola. Gentleman Relax armchair in removable fabric Siro 02 lino with base in glossy brown nickel. Carpet Plain tortora.

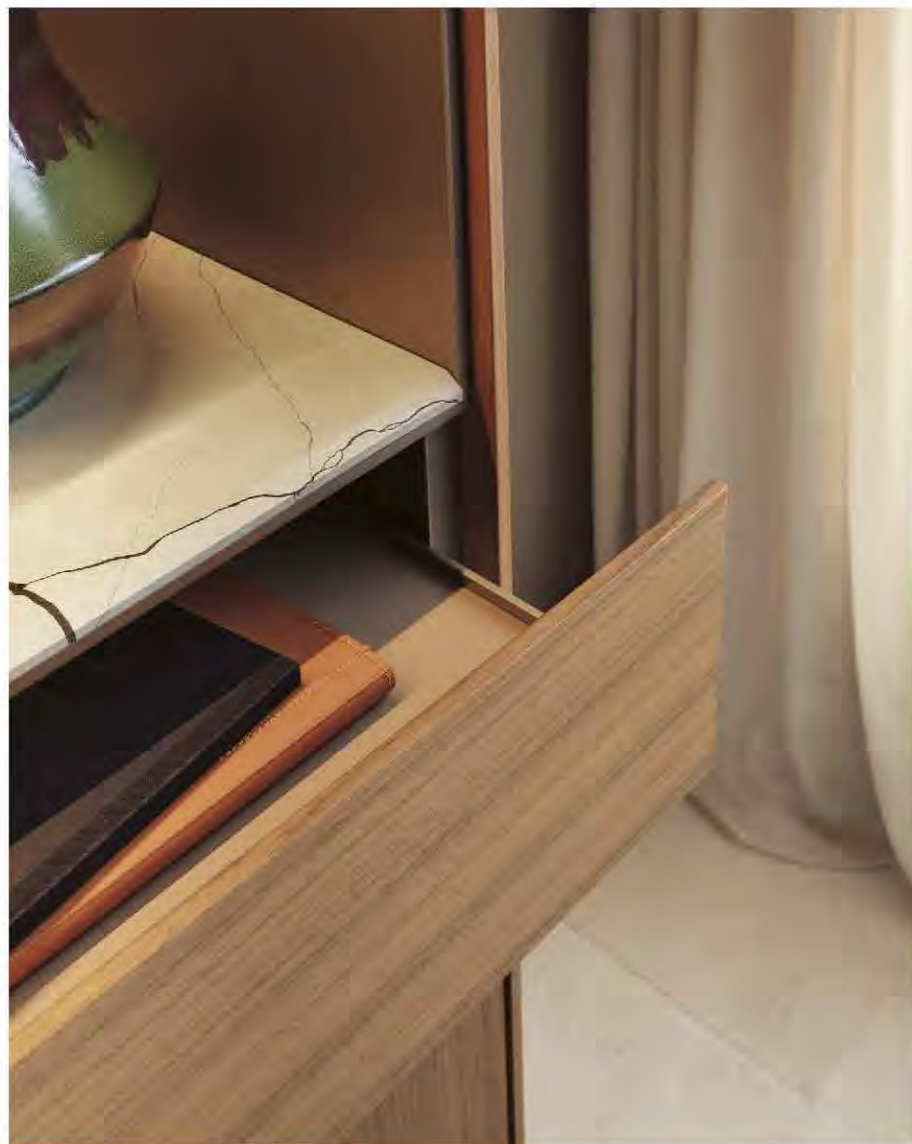





Qui e nelle pagine precedenti: madia Code in olmo nero e basamento con piedini in champagne opaco. Nella pagina successiva: madia Code in laccato semilucido granata con top in laccato metallico ottone. Vano a giorno in laccato opaco ottone. Basamento con piedini in ardesia opaco.

This and previous pages: Code sideboard in black elm and base with mat champagne feet. Following page: Code sideboard in semi-glossy lacquer granata with top in metal lacquer ottone. Open compartment in mat lacquer ottone. Base with feet in mat ardesia.



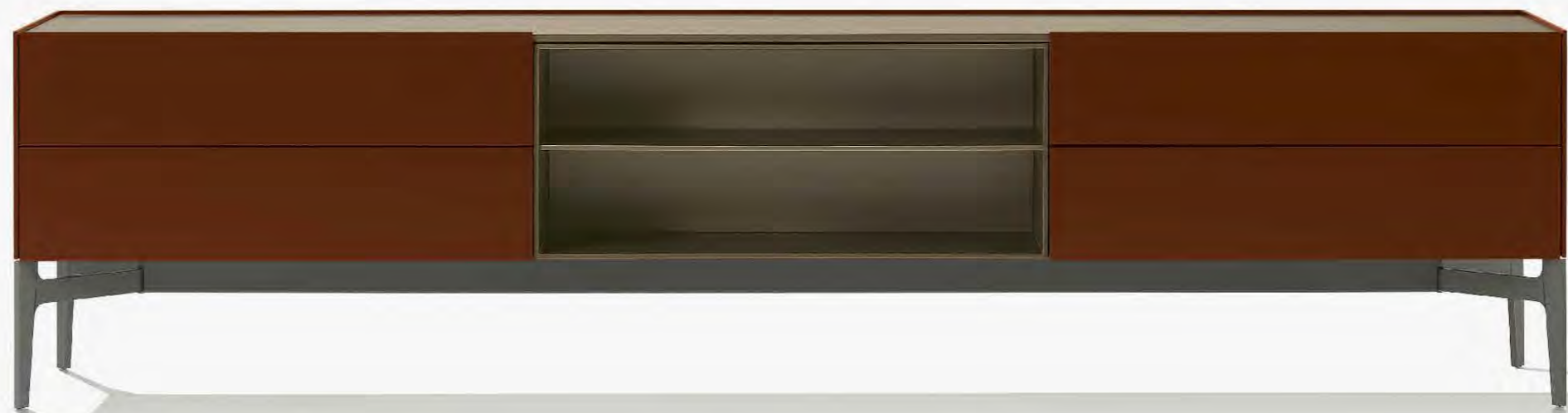



CODE SIDEBOARD

In questa pagina: madia Code in noce gold con top in marmo zecevo levigato, vani a giorno e struttura interna in laccato opaco ottone, basamento con piedini in champagne opaco. Boiserie Code in tessuto lino chiaro e profili champagne opaco. Specchio Circle, cornice in cuoio 02 nero e specchio bianco. Pouf New York in tessuto sfoderabile Antea 05 terra di siena. Sotto: dettaglio del top attrezzato con passacavi in champagne opaco.

This page: Code sideboard in gold walnut with top in mat marble zecevo, open compartments and inner structure in mat lacquer ottone, base with feet in mat champagne. Code wall panelling in fabric lino chiaro and mat champagne profiles. Circle mirror, frame in hide 02 nero and white mirror. New York pouf in removable fabric Antea 05 terra di siena. Below: close up of the accessorized top with cable passage channel in mat champagne.



CODE SIDEBOARD

Design R&D Pollform, 2020

Serie di madie con ante battenti vetro o legno, ante a ribalta, cassetti in due altezze e vani a giorno.

Frontali, fianchi, retro schienale e top in laccato opaco colori, laccato metallico colori, laccato semilucido colori, noce gold, olmo nero, rovere spessart o rovere gold. Top disponibile anche in sei marmi levigati e sei lucidi. Ante vetro, telaio ardesia opaco o champagne opaco e tre vetri, trasparente, fumé o trasparente riflettente.

Vani a giorno in laccato opaco colori. Schienali vani a giorno e madie alte in laccato opaco colori, laccato metallico colori, noce gold, olmo nero, rovere spessart, rovere gold o tessuto lino chiaro e lino scuro. Basamento con piedini o zoccolino in metallo verniciato ardesia opaco o champagne opaco.

Struttura interna in laccato opaco colori, noce gold, olmo nero, rovere spessart, rovere gold o nobilitato ardesia.

Interno cassetti in nobilitato ardesia, fondo opzionale in tecnopelle colori.

Attrezzature: ripiani legno o vetro e cassetti interni (cassetti solo con ripiani vetro).

Frontali cassetti interni e ripiani legno, finiture come struttura interna, frontali cassetti anche in laccato metallico colori.

Ripiani in vetro trasparente o vetro fumé.

Attrezzature opzionali: vassoi porta posate e porta fogli/penne finiture come struttura interna, fondo opzionale in tecnopelle colori; luce a led solo per madie alte.

Panca in laccato opaco colori, laccato metallico colori, laccato semilucido colori, noce gold, olmo nero, rovere spessart o rovere gold.

Series of sideboards with leaf doors in glass or wood, flap doors, drawers in two heights and open storage units.

Fronts, sides, rear-back panel and top in mat lacquered colours, metal lacquered colours, semi-glossy lacquered colours, gold walnut, black elm, spessart oak or gold oak. Top available also in six mat and six glossy marbles. Glass doors, mat ardesia or mat champagne frame and three glass finishes, transparent, fumé or transparent reflecting.

Open storage units in mat lacquered colours. Open compartments and high sideboards backs in mat lacquered colours, metal lacquered colours, gold walnut, black elm, spessart oak, gold oak or fabric lino chiaro and lino scuro. Base with feet or plinth in mat ardesia or mat champagne painted metal.

Inner structure in mat lacquered colours, gold walnut, black elm, spessart oak, gold oak or ardesia melamine.

Drawers interior in ardesia melamine, optional bottom in techno leather colours.

Equipment: wooden or glass shelves and inner drawers (drawers only with glass shelves). Inner drawers front and wooden shelves available in the same finishes of the inner structure, drawers front available also in metal lacquered colours. Glass shelves in transparent or fumé glass.

Optional equipment: cutlery or sheets/pens trays in the same inner structure finishes, optional bottom in techno leather colours; led lights available only for high sideboards.

Bench in mat lacquered colours, metal lacquered colours, semi-glossy lacquered colours, gold walnut, black elm, spessart oak or gold oak.



basamento con piedini h 265 mm
base with feet h 10 1/2"



zoccolino h 40 mm
plinth h 1 1/2"

h 565 con piedini - h 340 con zoccolino h 22 1/4" with feet - h 13 1/2" with plinth

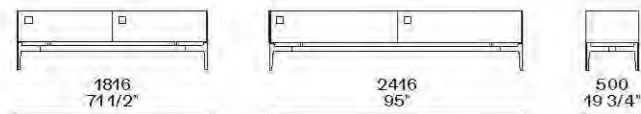

h 668 con piedini - h 443 con zoccolino h 26 1/4" with feet - h 17 1/2" with plinth

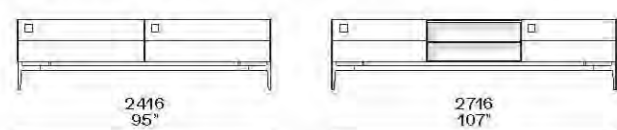

h 771 con piedini - h 546 con zoccolino h 30 1/4" with feet - h 21 1/2" with plinth

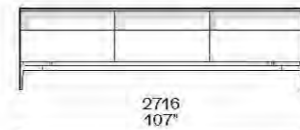

■ anta ribalta
flap door

□ disponibile anche con anta ribalta
also available with flap door

● luce a led opzionale
optional led light

h 871 con piedini - h 646 con zoccolino h 34 1/4" with feet - h 25 1/2" with plinth

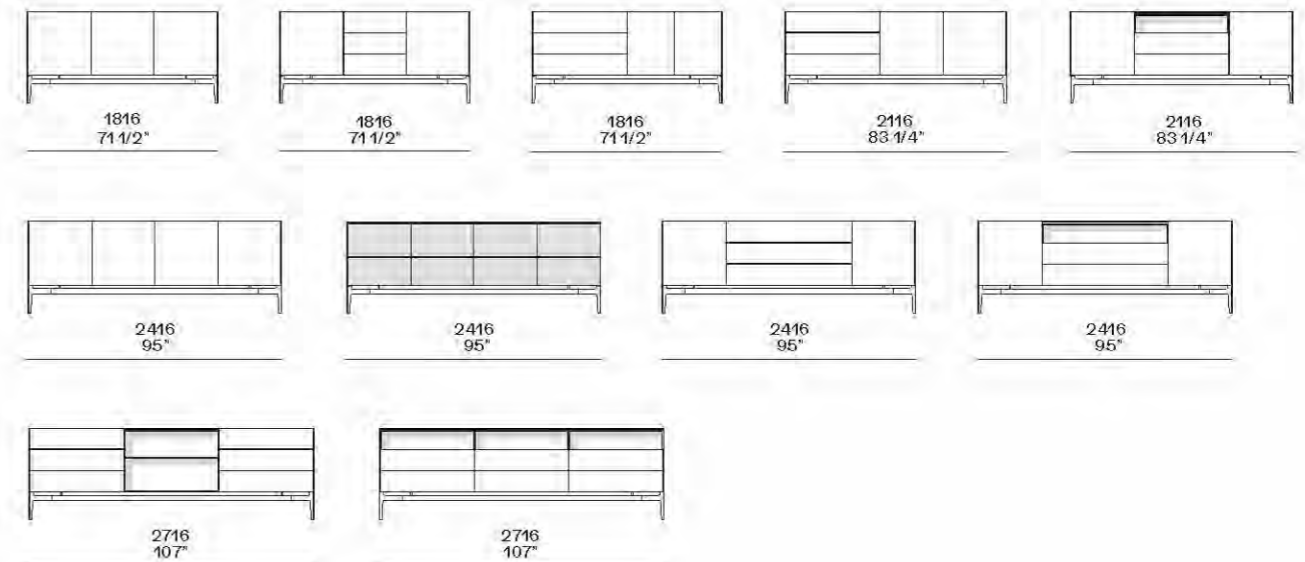

Madia alta - h 1454 solo con piedini High sideboard - h 57 1/4" only with feet

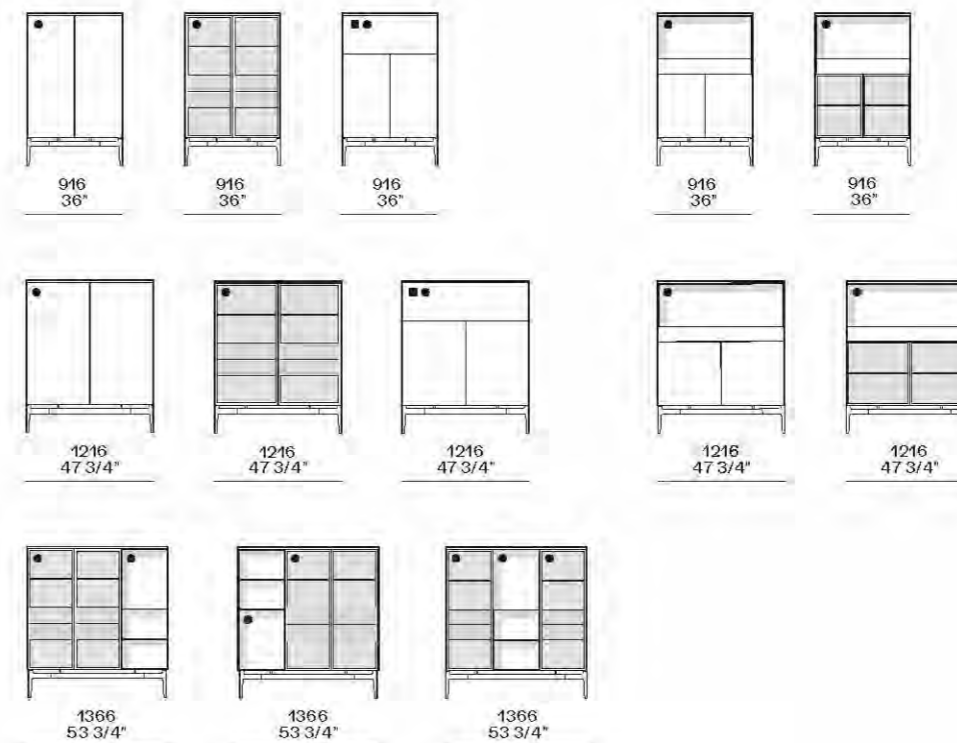

Lo schienale del vano a giorno di queste quattro configurazioni è disponibile anche in specchio bronzato e specchio bianco. Sopra al vassoio è previsto un top interno, disponibile in tutte le finiture previste per i top.

The back of the open compartment in these four configurations is available also in bronzed mirror and white mirror. An internal top is provided above the tray available in all the finishes foreseen for tops.

Panca solo con piedini Bench only with feet



MONDRIAN

Jean-Marie Massaud reinterpreta il design leggero ed elegante della collezione Mondrian nel tavolo da pranzo. Tre le varianti del piano, ovale, rettangolare o rotondo, in legno, vetro o marmo. La particolare base in metallo può essere declinata in due tonalità.

Jean-Marie Massaud reinterprets the light and elegant design of the Mondrian collection with the dining table. Three variants of the top, oval, rectangular or round, in wood, glass, or marble. The particular metal base is available in two colours.







Qui, nelle pagine precedenti e in chiusura: tavolo Mondrian con piano in marmo levigato sahara noir finitura poliestere e struttura in brown nickel opaco. Sedie Manta con braccioli in pelle non sfoderabile Silk 10 terracotta. Sistema Code, ante in laccato metallico bronzo con maniglia ardesia opaco e in vetro trasparente riflettente con telaio e maniglia ardesia opaco. Top retroilluminato in marmo zecevo levigato e fianchi in laccato metallico bronzo. Struttura interna in laccato opaco bronzo, vetrine e vani a giorno con schienali in tessuto lino chiaro e luce a led integrata. Contenitori vetrina con ripiani in vetro trasparente e cassetti in laccato metallico bronzo con piano superiore in marmo zecevo levigato. Pouf New York in tessuto sfoderabile Antea 05 terra di siena. Tappeto Tratto ruggine.

This, previous pages and closing pages: Mondrian table with top in marble sahara noir, polyester finish and mat brown nickel structure. Manta chairs with armrests in non-removable leather Silk 10 terracotta. Code system, doors in metal lacquer bronzo with mat ardesia handle and in transparent reflecting glass with frame and handle in mat ardesia. Backlit top in mat marble zecevo and sides in metal lacquer bronzo. Inner structure in mat lacquer bronzo, display cases units and open compartments with backs in fabric lino chiaro and integrated led light. Display case storage units with shelves in transparent glass and drawers in metal lacquer bronzo with upper shelf in mat marble zecevo. New York pouf in removable fabric Antea 05 terra di siena. Carpet Tratto ruggine.



In questa pagina: tavolo Mondrian con piano in noce gold e struttura in champagne opaco. Nella pagina successiva: tavolo Mondrian con piano in marmo calacatta oro levigato e struttura in champagne opaco.

This page: Mondrian table with top in gold walnut and structure in mat champagne. Following page: Mondrian table with top in mat marble calacatta oro and structure in mat champagne.





In questa pagina: tavolo Mondrian con piano in vetro fumé e struttura in brown nickel opaco.

This page: Mondrian table with top in fumé glass and mat brown nickel structure.





MONDRIAN

Design Jean-Marie Massaud, 2019

Struttura in fusione di alluminio verniciato brown nickel opaco o champagne opaco. Piano in olmo nero, noce gold, rovere spessart o cinque marmi levigati (escluso zecevo) e sei lucidi. Disponibile anche con piano in vetro fumé escluso Ø 1400 e rettangolare l 3200.

Structure in aluminium casting painted mat brown nickel or mat champagne. Top in black elm, gold walnut, spessart oak or five mat (except zecevo) and six glossy marbles. Available also with top in fumé glass except Ø 1400 and rectangular w 3200.

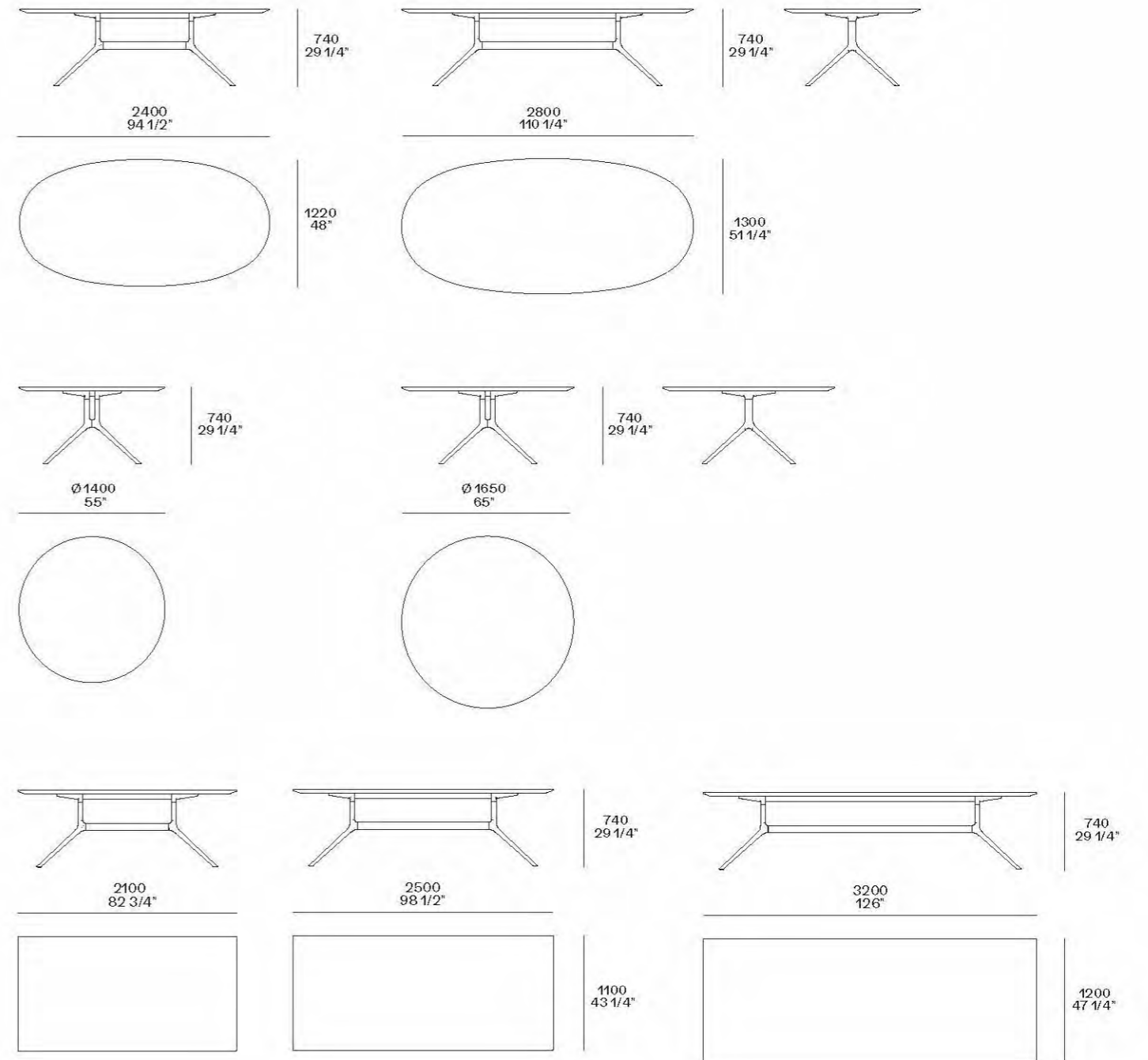

HENRY

Evoluzione dell'omonimo tavolino, Henry è un tavolo da pranzo allungabile dalle dimensioni importanti. Pensato per la convivialità, è disponibile nelle versioni rettangolare e quadrata, sempre con angoli stondati. Eleganti le finiture: la struttura è in legno massello, caratterizzata da una raffinata lavorazione di ebanisteria. Il piano è in legno, marmo o vetro.

An evolution of the homonymous coffee table, Henry is a large, extendable dining table. Designed for conviviality, it is available in the rectangular and square versions, always with rounded corners. The finishes are elegant: the structure is in solid wood, characterized by a refined cabinetwork. The top is in wood, marble, or glass.





Nelle pagine precedenti e in chiusura: tavolo Henry in olmo nero con piano in marmo sahara noir levigato finitura poliestere. Sedie Sophie in tessuto non sfoderabile Kitami O4 sabbia e struttura in olmo nero. Madia Code in olmo nero con top in marmo zecevo levigato e basamento con piedini ardesia opaco. Ante in vetro trasparente riflettente, struttura interna in olmo nero con schienale in tessuto lino chiaro. Tappeto Tratto ruggine. In questa pagina: tavolo Henry in olmo nero con piano in vetro lucido bordeaux. Nella successiva: tavolo Henry in noce gold con piano in marmo calacatta oro levigato.

Previous pages and closing pages: Henry table in black elm with top in mat marble sahara noir with polyester finish. Sophie chairs in non-removable fabric Kitami O4 sabbia and black elm structure. Code sideboard in black elm with top in mat marble zecevo and base with feet in mat ardesia. Doors in transparent reflecting glass, inner structure in black elm with back in fabric lino chiaro. Carpet Tratto ruggine. This page: Henry table in black elm with top in glossy glass bordeaux. Following page: Henry table in gold walnut with top in mat marble calacatta oro.







Qui e nella pagina successiva: tavolo Henry allungabile in olmo nero. Il piano in legno è caratterizzato dall'accostamento di lastre con venatura a spina di pesce.

This and following page: Henry extendable table in black elm. The veneer with herringbone grain distinguishes the top in wood.







HENRY
Design Emmanuel Gallina, 2019

Tavolo fisso o allungabile. Struttura in massello, finitura olmo nero, rovere spessart o noce gold. Piano in olmo nero, rovere spessart, noce gold, cinque marmi levigati (escluso zecevo) e sei lucidi o vetro lucido nei colori ghiaccio, arena, grafite, bordeaux. Il piano nella versione legno è caratterizzato dall'accostamento di lastre con venatura a spina di pesce (escluso allunghe). La versione allungabile prevede solo il piano in olmo nero, rovere spessart o noce gold.

Fixed or extendable table. Solid wood structure, black elm, spessart oak or gold walnut finish. Top in black elm, spessart oak, gold walnut, five mat (except zecevo) and six glossy marbles or glossy glass in the colours ghiaccio, arena, grafite, bordeaux. The top in the wooden version is characterized by the combination of veneers with herringbone grain (except extensions). The extendable version is available only with top in black elm, spessart oak or gold walnut.

Piano in legno
Wooden top

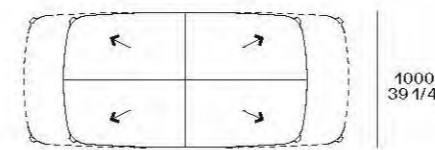
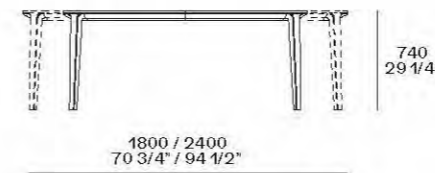

1000
39 1/4"

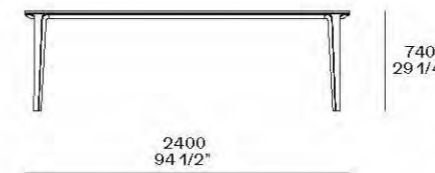

740
29 1/4"



740
29 1/4"

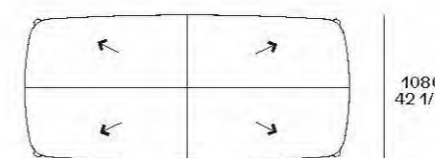

1080
42 1/2"



1080
42 1/2"

Le frecce indicano l'orientamento delle venature del legno.
The arrows show the direction of the wooden grain.

Piano in marmo e vetro
Marble and glass top

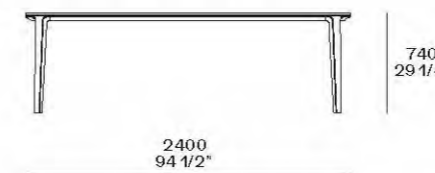

740
29 1/4"



740
29 1/4"

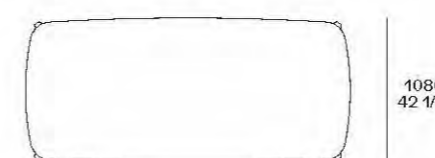

1080
42 1/2"

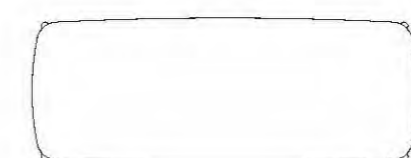

1080
42 1/2"



HOME HOTEL

Nuova finitura per il tavolo della collezione Home Hotel disegnato da Jean-Marie Massaud. Il piano in marmo è integrato nello spessore del legno, una lavorazione di grande maestria che unisce estetica e saper fare.

New finish for the table of the Home Hotel collection designed by Jean-Marie Massaud. The marble top is integrated into the thickness of the wood, a work of great mastery that combines style and know-how.





Nelle pagine precedenti: tavolo Home Hotel in olmo nero. Sedie Seattle con braccioli, seduta e gambe rivestite in cuoio non sfoderabile 29 tortora. Tappeto Frame perla. In questa pagina: tavolo Home Hotel con piano in marmo bianco carrara levigato, struttura e piano centrale girevole integrato in olmo nero. Nella pagina successiva: tavolo Home Hotel con piano in marmo sahara noir levigato e struttura in noce gold.

Previous pages: Home Hotel table in black elm. Seattle chairs with armrests, seat and legs covered in non-removable hide 29 tortora. Carpet Frame perla. This page: Home Hotel table with top in mat marble bianco carrara, structure and integrated swivel top in black elm. Following page: Home Hotel table with top in mat marble and gold walnut structure.

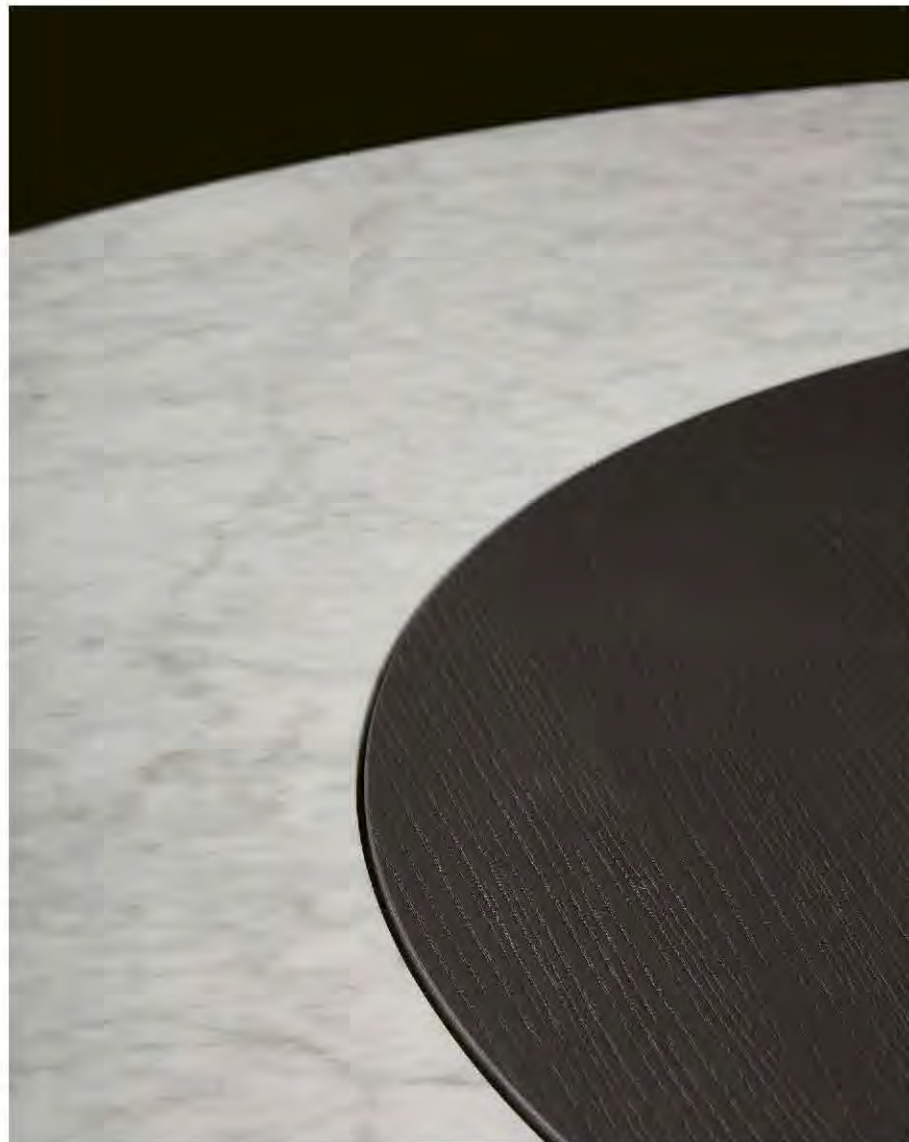

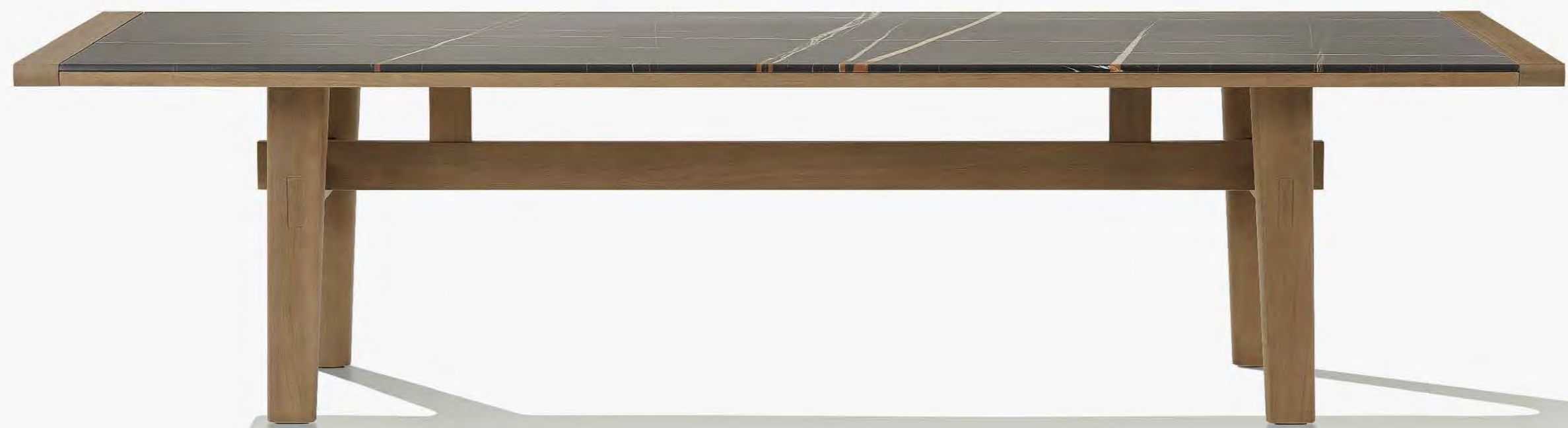



In questa pagina: tavolo Home Hotel con piano e struttura in olmo nero. Nella pagina successiva: tavolo Home Hotel in olmo nero con piano centrale girevole integrato in marmo noir saint laurent lucido. Sedie Ipanema con braccioli, rivestimento non sfoderabile in pelle Soft 04 cognac, struttura in olmo nero. Tappeto Plain tortora.

This page: Home Hotel table with top and structure in black elm. Next page: Home Hotel table in black elm with integrated swivel top in glossy marble noir saint laurent. Ipanema chairs with armrests, non-removable cover in leather Soft 04 cognac, structure in black elm. Carpet Plain tortora.







HOME HOTEL

Design Jean-Marie Massaud, 2016-2019

Struttura in massello finitura olmo nero o massello noce gold. Versione in noce gold disponibile solo con piano in marmo.

Piano in olmo nero, cinque marmi levigati (escluso zecevo) e sei lucidi.

I tavoli \varnothing 1800 e 2000 mm hanno un piano girevole integrato in olmo nero, cinque marmi levigati (escluso zecevo) e sei lucidi. Per i tavoli \varnothing 1800 e 2000 con piani in marmo, il piano girevole è disponibile solo in olmo nero o noce gold.

Structure in solid wood finish black elm or solid gold walnut. Version in gold walnut available only with top in marble.

Top in black elm, five mat marbles (except zecevo) and six glossy marbles.

The tables \varnothing 70 3/4" and 78 3/4" have an integrated swivel top in black elm, five mat (except zecevo) and six glossy marble finishes. For tables \varnothing 70 3/4" and 78 3/4" with marble top the swivel top is available only in black elm or gold walnut.

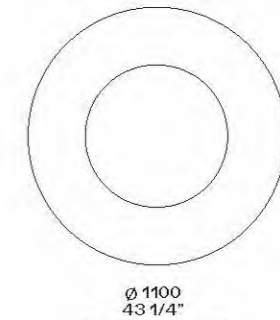
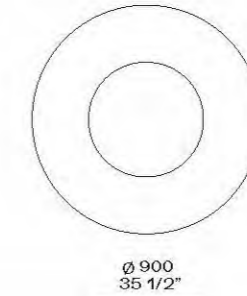
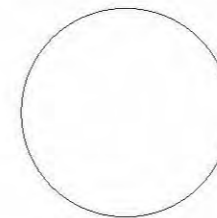
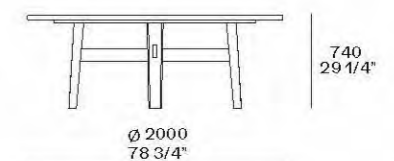
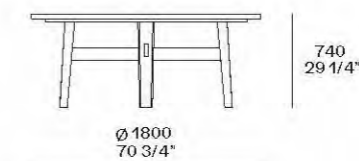
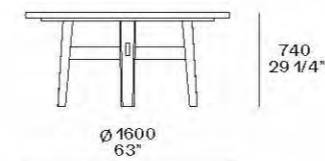
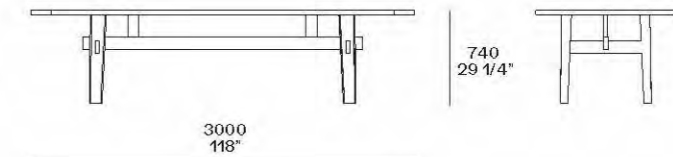
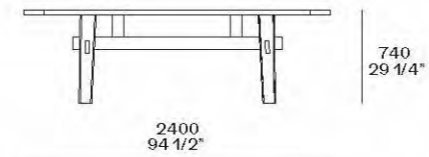

SOPHIE LITE

In questa pagina: sedia Sophie Lite con bracciolo, rivestimento sfoderabile in pelle Silk 02 beige e struttura in rovere spessart.

This page: Sophie Lite chair with armrest, cover in removable fabric in leather Silk 02 beige and structure in spessart oak.





In questa pagina: sedia Sophie Lite con bracciolo, rivestimento sfoderabile in tessuto Micene 08 argilla e struttura in olmo nero.

This page: Sophie Lite chair with armrest, cover in removable fabric in fabric Micene 08 argilla and black elm structure.



In questa pagina: sedia Sophie Lite senza bracciolo, rivestimento sfoderabile in tessuto Skyros 04 visone e struttura in olmo nero. Nella pagina successiva: sgabello Sophie Lite, rivestimento sfoderabile in tessuto Antea 03 visone, struttura in olmo nero e poggiatesta in brown nickel opaco.

This page: Sophie Lite chair without armrests, cover in removable fabric Skyros 04 visone and black elm structure. Following page: Sophie Lite stool, removable cover in fabric Antea 03 visone, structure in black elm and footrest in mat brown nickel.





SOPHIE LITE

Design Emmanuel Gallina, 2020

Seduta e schienale con parti in poliuretano flessibile a quote differenziate e parti in poliuretano flessibile stampato, prriverestimento in fibra di poliestere. Rivestimento sfoderabile in tessuto o pelle. Struttura in massello, finitura in rovere spessart, olmo nero o noce gold. Sgabello con poggipiedi in metallo verniciato brown nickel opaco.

Seat and backrest with parts in flexible polyurethane in different densities and parts in flexible moulded polyurethane, pre-cover in polyester fibre. Removable cover in fabric or leather. Structure in solid wood, spessart oak, black elm or gold walnut finish. Stool with footrest in mat brown nickel painted metal.

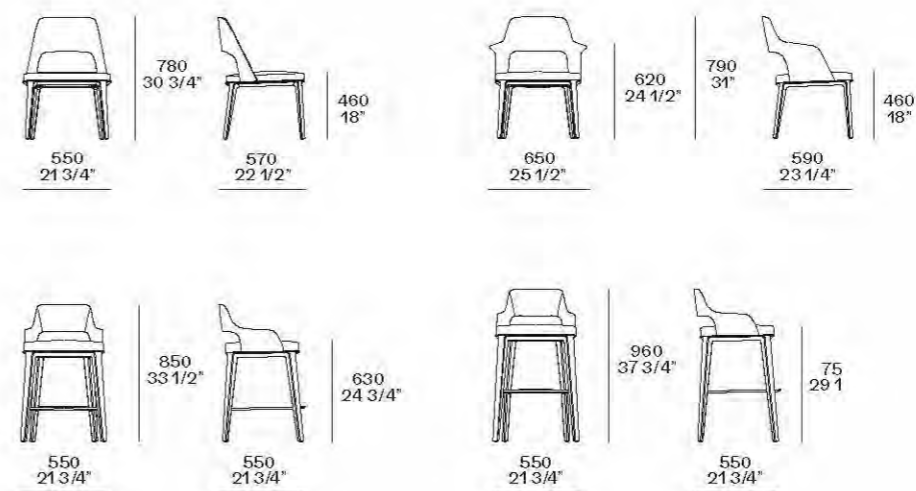

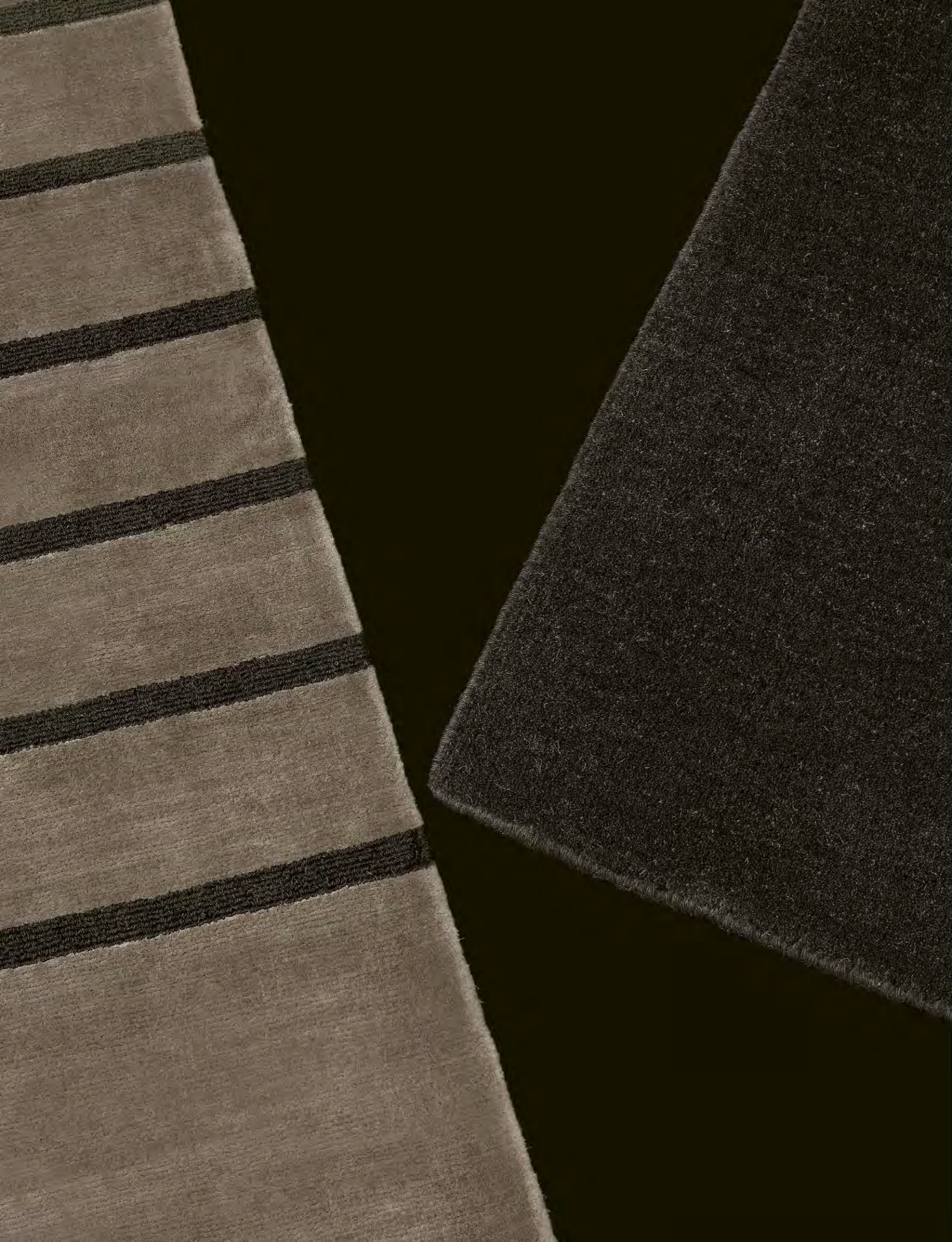

TRATTO

Tratto è un tappeto realizzato in un blend di lana himalayana, morbida al tatto, e seta di bambù, che rende il decoro cangiante. È caratterizzato dai motivi geometrici e disponibile in tre vibranti combinazioni di colore.

Tratto is a rug made of a blend of Himalayan wool, soft to the touch, and bamboo silk, which makes the decoration iridescent. It is characterized by geometric patterns and available in three vibrant colour combinations.





TRATTO

Design R&D Poliform, 2019

Prodotto a mano con tecnica Handloom.
Trama in cotone, vello in lana himalayana
e seta di bambù.
Dimensioni mm: rettangolare 1700x2400
2300x3000 - 3000x4000
quadrato 3000x3000.

Handmade with the Handloom technique.
Cotton weave, fleece in himalayan wool
and bamboo silk.
Dimensions in: rectangular 67"x94 1/2" 90
1/2"x118" - 118"x157 1/2" square 118"x118".



Ruggine



Carbone



Tortora

Nella pagina precedente: tappeto Tratto carbone. In questa pagina
tappeto Tratto ruggine.

Previous page: carpet Tratto carbone. This page, carpet Tratto ruggine.

TECHNICAL DATA

FINITURE
FINISHINGS

210

INDICE PRODOTTI
PRODUCT INDEX

218

FINITURE
FINISHINGS

Laccato opaco
Mat lacquer

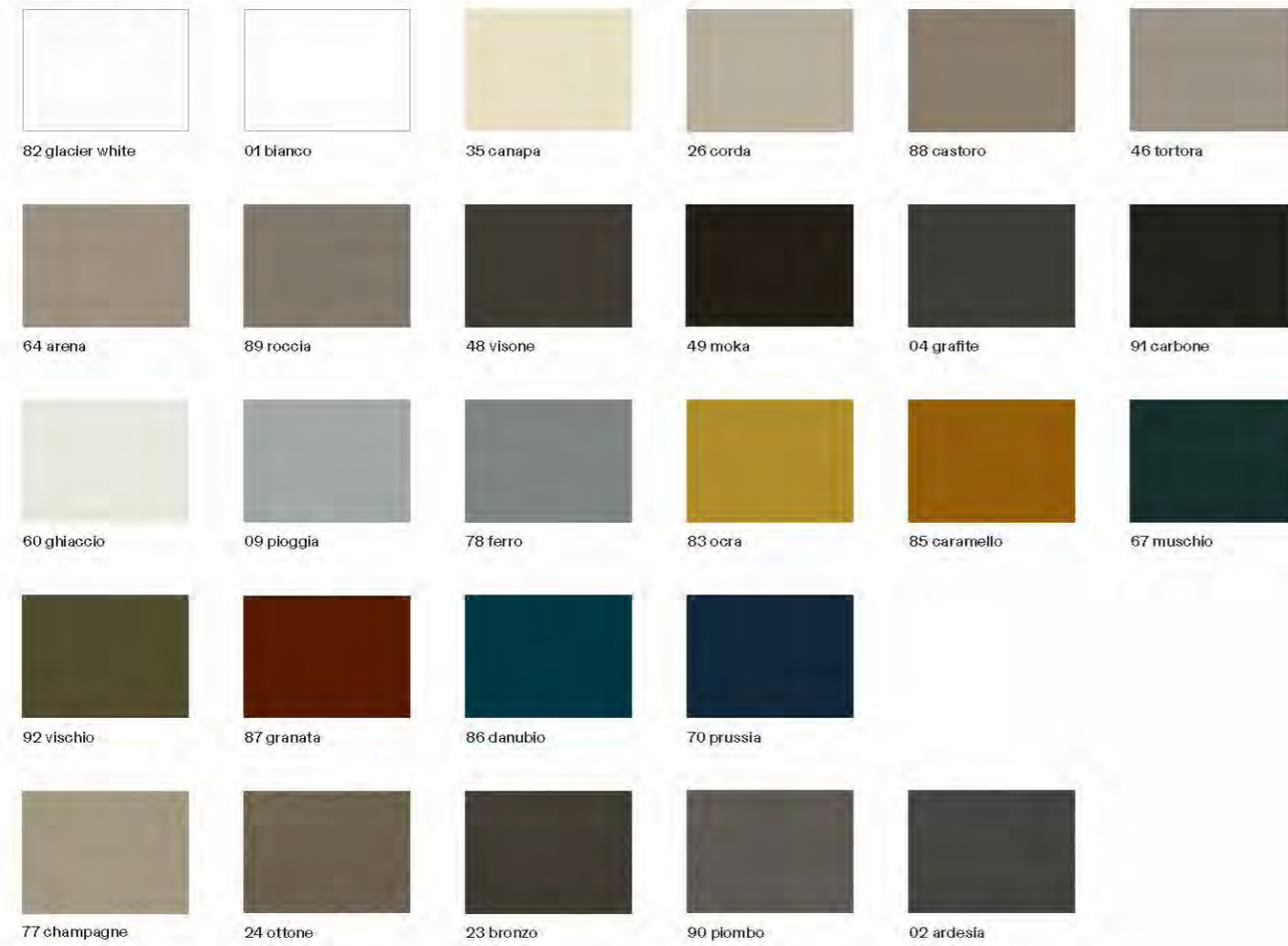

Laccato semilucido
Semi-glossy lacquer

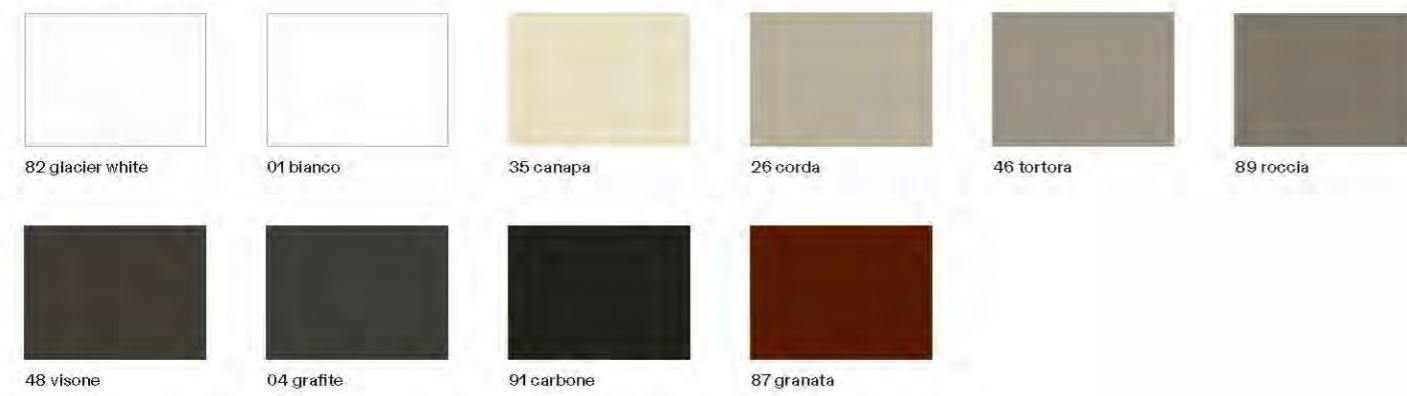

Laccato lucido
Glossy lacquer



Laccato antigraffio
Antiscratch lacquer



Laccato metallico
Metallic lacquer



FINITURE
FINISHINGS

**Essenza
Wood**



rovere gold
gold oak



rovere spessart
spessart oak



noce gold
gold walnut



noce c.
walnut c.



olmo nero
black elm



massello noce canaletto
solid walnut canaletto



rovere naturale
natural oak



cedro
cedar

**Marmo levigato
Mat marble**



bianco carrara



calacatta oro



grigio stardust



emperador dark



sahara noir
finitura poliestere
polyester finish



zecevo

**Marmo lucido
Glossy marble**



bianco carrara



calacatta oro



grigio stardust

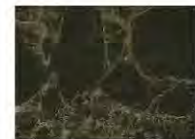

emperador dark



sahara noir
finitura poliestere
polyester finish



noir saint laurent

**Gabbro
Gabbro**



nero assoluto
texture juta

**Onice
Onyx**



ambra
amber

**Semiprezioso
Semiprecious stone**



lapislazzulo blu
blue lapis lazuli

**Cuoio
Hide**



28 avorio



29 tortora

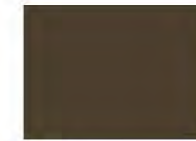

19 caffè



38 oliva



15 prugna



26 invecchiato



03 grigio scuro



02 nero

**Tecnopelle
Techno leather**



05 latte



01 elefante



02 moro



06 nocciola

**Tessuto
Fabric**



lino chiaro



lino scuro

**FINITURE
FINISHINGS**

**Tessuti
Fabrics**

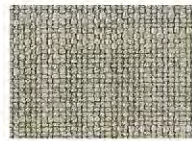

atlanta cat. b
12 colori - colours



caleo cat. b
15 colori - colours



chios cat. b
13 colori - colours



eraclea cat. b
12 colori - colours

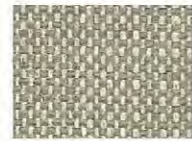

aspen cat. c
12 colori - colours

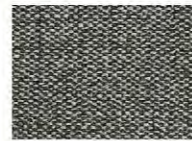

lima cat. c
11 colori - colours



siviglia cat. c
14 colori - colours



antea cat. d
13 colori - colours



caledonia cat. d
9 colori - colours



cordoba cat. d
13 colori - colours



corinto cat. d
5 colori - colours



indra cat. d
12 colori - colours



itaca cat. d
10 colori - colours

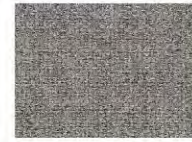

kushiro cat. d
13 colori - colours



lipsi cat. d
11 colori - colours



micene cat. d
9 colori - colours



milos cat. d
5 colori - colours



olimpia cat. d
14 colori - colours

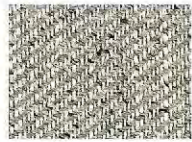

oxford cat. d
8 colori - colours



rabat cat. d
10 colori - colours



sendai cat. d
5 colori - colours



sparta cat. d
12 colori - colours



arcadia cat. e
12 colori - colours



argo cat. e
13 colori - colours



hannover cat. e
11 colori - colours



kitami cat. e
12 colori - colours



merida cat. e
8 colori - colours



naxos cat. e
11 colori - colours



nayoro cat. e
10 colori - colours



norway cat. e
13 colori - colours



orleans cat. e
10 colori - colours



paros cat. e
11 colori - colours



persia cat. e
16 colori - colours



salford cat. e
11 colori - colours



skyros cat. e
12 colori - colours



zante cat. e
11 colori - colours



lero cat. g
2 colori - colours



siro cat. g
4 colori - colours



tebe cat. g
11 colori - colours



gibson cat. z
8 colori - colours

**Pelle
Leather**



spring cat. p
13 colori - colours



colors cat. s
25 colori - colours



silk cat. s
13 colori - colours



silk intrecciata cat. s
woven leather silk
13 colori - colours



vintage cat. s
5 colori - colours



special cat. x
21 colori - colours



nabuk cat. y
10 colori - colours



nabuk intrecciata cat. y
woven leather nabuk
10 colori - colours



invecchiata cat. y
6 colori - colours



soft cat. y
14 colori - colours

**Pelle Cashmere
Cashmere leather**



bianco



grigio



nero

**Pelle Hairy
Hairy leather**



bianco/nero



cappuccino

**Bordura gros-grain - bordura in seta - filati
Grosgrain border - silk border - yarns**



burro



perla



sahara



rubino



tempesta



navy



acciaio



nero

● escluso bordura in seta
except silk border

**Provence coordinati letto
Bed linen Provence**



01 bianco



02 panna



08 polvere



04 tortora



06 roccia



07 grafite



03 ghiaccio

**FINITURE
FINISHINGS**

**Vetro
Glass**

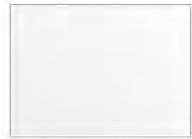

1000 trasparente
transparent

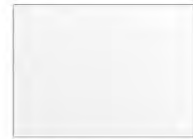

2000 trasparente
extrachiaro-transparent
extralight



3050 fumé

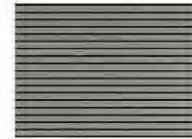

2700 line

**Vetro riflettente
Reflecting glass**



5000 trasparente
transparent



5010 blu



5051 bronzato
bronzed



5059 fumé

**Vetro acidato
Etched glass**



5380 acciaio



5323 bronzo



5325 titanio

**Specchio
Mirror**



4000 bianco
white



4051 bronzato
bronzed

**Vetro satinato
Mat glass**

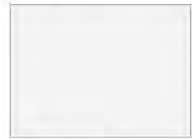

2301 bianco



2373 ghiaccio



1335 canapa



1364 arena



1304 grafite



1303 nero

**Vetro lucido
Glossy glass**

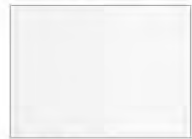

2201 bianco



2273 ghiaccio



1235 canapa



1264 arena



1204 grafite



1203 nero



1259 bordeaux

**Nobilitato
Melamine**



olmo
elm



noce c.
walnut c.



rovere cenere
cenere oak



rovere spessart
spessart oak



canvas beige



canvas grigio



graffiti 01 bianco



graffiti 35 canapa



graffiti 60 ghiaccio



silk canapa



silk grey



silk bronzo



club 01 bianco



skin
27 colori laccato opaco
27 mat lacquered colours



skin 94 latte
laccato opaco
mat lacquered



skin 97 elefante
laccato opaco
mat lacquered



skin 93 moro
laccato opaco
mat lacquered



skin 98 nocciola
laccato opaco
mat lacquered

**Nobilitato interno cassetti
Melamine drawers structure**



ardesia



madras
Quid sistema giorno -
day system



roller latte



roller ardesia

**Parti metalliche
Metal parts**

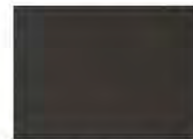

brown nickel opaco
mat brown nickel

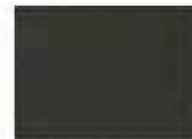

brown nickel lucido
glossy brown nickel



brown nickel satinato
brushed brown nickel



champagne opaco
mat champagne



champagne satinato
brushed champagne

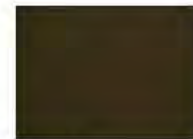

bronzato
bronzed



piombo mat
mat piombo



ardesia opaco
mat ardesia



cromo satinato
brushed chrome



cromo nero
black chrome



cromo nero satinato
brushed black chrome



bronzo anticato
antique bronze



spatolato ferro
spatula-finish ferro

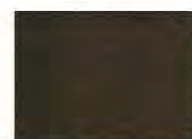

spatolato bronzo
spatula-finish bronzo



oro lucido
glossy gold



alluminio brill
aluminium brill

DIVANI
SOFAS



Westside, design Jean-Marie Massaud
pp. 8-47



Gentleman's Friends, design Marcel Wanders
pp. 92-117

TAVOLINI
COFFEE TABLES



Westside, design Jean-Marie Massaud
pp. 48-63



Nara, design Jean-Marie Massaud
pp. 64-73

POLTRONE
ARMCHAIRS



Gentleman Single, design Marcel Wanders
pp. 92-117



Gentleman Relax, design Marcel Wanders
pp. 92-117



Gentleman Reserved, design Marcel Wanders
pp. 92-117



Kay Lounge, design Jean-Marie Massaud
pp. 74-91

MADIE
SIDEBOARDS



Code, design R&D Poliform
pp. 118-143

TAVOLI
TABLES



Mondrian, design Jean-Marie Massaud
pp. 144-159



Henry, design Emmanuel Gallina
pp. 160-175



Home Hotel, design Jean-Marie Massaud
pp. 176-191

SEDIE E SGABELLI
CHAIRS AND STOOLS



Sophie Lite, design Emmanuel Gallina
pp. 192-201



Sophie Lite, design Emmanuel Gallina
pp. 200-201

TAPPETI
CARPETS



Tratto, design R&D Poliform
pp. 202-207

Poliform Spa
via Montesanto 28
Casella postale n. 1
22044 Inverigo (CO) Italy
t +39 031 6951
f +39 031 699444
info@poliform.it
poliform.it



Poliform realizza tutte le sue collezioni in Italia usando componenti e materie prime selezionate.

All the Poliform collections are manufactured 100% in Italy using top-class components and materials.

Poliform si riserva il diritto di apportare, senza preavviso, ogni modifica mirata al miglioramento funzionale e qualitativo dei propri prodotti. Testi e disegni presenti in questo stampato hanno scopo divulgativo; per ogni aspetto tecnico e dimensionale fare riferimento ai listini aziendali e relativi aggiornamenti. I campioni di colori e materiali hanno valore indicativo.

Poliform reserves the rights at all time to apply modifications for the functional or qualitative improvement of its products. Texts and drawings present in this brochure have a divulgative purpose; for every technical and dimensional aspect please refer to the company's price lists and their relative updates. The colour and material samples have an indicative value.

Creative Direction
Apartamento Studios

Graphic Design
Apartamento Studios

Interiors Photography
Omar Sartor

Still Life Photography
Silvia Orlandi

Interiors Styling
Poliform Lab

1st edition April 2020
cod. 114/R1/2020



TWENTY TWENTY