

KITCHEN COLLECTION

Poliform

Poliform

Poliform è una delle realtà più significative nel mondo dell'arredamento internazionale per qualità del design, eccellenza del progetto e innovazione. Il suo talento è il saper fare, una capacità che unisce cultura e conoscenza e che prima di essere un gesto, il gesto che rende riconoscibile tutto ciò che è firmato Poliform, è un'idea di progettazione. Un pensiero che unisce ricerca di funzionalità, contenuti espressivi e significati, e che della combinazione tra estetica e utilità ha saputo fare un'arte, in ogni area della casa. In cucina, quest'arte si esprime attraverso sistemi dal design eccellente, che rispondono alle esigenze delle persone e ne appagano i sensi, giorno dopo giorno.

Poliform is one of the most important companies in the world of international furniture for design quality, project excellence, and innovation. Its talent is the know-how, a skill that unites culture and knowledge and that, before being a gesture, the gesture that makes everything signed Poliform recognizable, it is a design idea. A thought that combines research of functionality, expressive contents, and meanings, and that has been able to make an art of the combination of aesthetics and utility, in every area of the house. In the kitchen, this art is expressed through systems with excellent design, which meet people's needs and satisfy their senses, day after day.



ART OF THE KITCHEN

La cucina è un luogo particolare, l'unico della casa che ha una funzione specifica: preparare i cibi. Tanti sono i modelli, tutti progettati per rendere più semplici i flussi di lavoro e mettere al centro le persone e le loro esigenze.

The kitchen is a particular place, the only one in the house that has a specific function: preparing food. There are many models, all designed to simplify workflows and put people and their needs at the centre.





Sciacquare, lavare, inumidire, bagnare, sbollentare.
In cucina l'acqua ha un ruolo di primo piano, così
come il lavello e i piani di lavoro, che si distinguono
per eccellenza tecnica e durabilità.

Rinsing, washing, dampening, wetting, boiling.
In the kitchen, water plays a leading role,
as does the sink and worktops, which stand
out for technical excellence and durability.

L'idea del cibo passa anche attraverso l'atto della cottura e le sue mille declinazioni. Per questo il fuoco e le sue evoluzioni più contemporanee, tra materiali innovativi e accessori dedicati, rappresentano il centro di ogni cucina.

The idea of food also passes through the act of cooking and its thousands of variations. This is why hobs and their most contemporary evolutions, between innovative materials and dedicated accessories, represent the centre of every kitchen.





L'attenzione alla qualità della vita si misura anche attraverso il silenzio e la pulizia dell'aria, due proprietà difficili da percepire che rendono molto più piacevole il tempo trascorso in cucina.

Attention to quality of life is also measured through silence and cleanliness of the air, two properties that are difficult to perceive that make the time spent in the kitchen much more pleasant.

Per conservarsi, il cibo ha bisogno di particolari condizioni di temperatura, illuminazione e umidità. O di soluzioni speciali come la cantina per il vino, che preserva profumi, colori e sensazioni gustative.

To be preserved, food needs special conditions of temperature, lighting, and humidity. Or special solutions like the wine cellar, which preserves aromas, colours and flavours.





Il segreto di ogni cucina è l'organizzazione, la perfetta interazione tra gli elementi che ne accresce l'utilità e migliora l'esperienza complessiva. Perché tutto è più semplice quando ogni cosa è a portata di mano, grazie a una varietà di attrezzature specifiche.

The secret of every kitchen is organization, the perfect interaction between the elements that increases its usefulness and improves the overall experience. Because everything is easier when everything is at hand, thanks to a variety of specific equipment.

La cucina nasconde dettagli di grande qualità come gli accessori, che moltiplicano spazi e funzionalità per rispondere a tutte le necessità di riordino e contenimento.

The kitchen hides details of great quality such as accessories, which multiply spaces and functionalities to meet all the needs of reorganization and storage.





In cucina l'ordine ha conquistato ogni ambito – all'insegna dell'attenzione all'ambiente e di una sensibilità ecologica che può avere un impatto concreto sul futuro, un gesto alla volta.

In the kitchen, order has conquered every area – in the name of attention to the environment and an ecological sensitivity that can have a concrete impact on the future, one gesture at a time.

Spezie, semi e legumi. Frutti dai colori vivi
e verdure dalle forme più strane.

La cucina è prima di tutto un luogo dove
la bellezza fa capolino dappertutto, anche da mensole
e Shaker – proposti in un'ampia gamma di finiture.

Spices, seeds, and legumes. Fruits with vivid colours
and vegetables with the strangest shapes.
The kitchen is first and foremost a place where beauty
peeks out from everywhere, including shelves
and Shakers – offered in a wide range of finishes.





In cucina non c'è spazio sprecato, né fuori né dentro i luoghi di contenimento, perché modularità e dimensioni sono ottimizzate in modo tale che ogni cosa abbia il suo posto.

In the kitchen there is no wasted space, neither outside nor inside the storage areas, because modularity and dimensions are optimized so that everything has its place.

Anche in cucina ci sono tesori da custodire – dalle ceramiche alla cristalleria, dal servizio antico alle icone del design contemporaneo. Oggetti dall'alto valore percepito che vanno protetti e valorizzati con vetrine e luci.

Even in the kitchen there are treasures to keep – from ceramics to glassware, from antique sets to icons of contemporary design. Objects with a high perceived value that must be protected and enhanced with display cabinets and lights.





Mangiare è un atto che coinvolge tutti i sensi con sapori, profumi, colori, suggestioni tattili e sensazioni uditive. La cucina è dunque lo spazio sensoriale per eccellenza, dove s'incontrano razionalità ed emozione e funzione ed estetica sono in perfetto equilibrio.

Eating is an act that involves all the senses with flavours, aromas, colours, tactile sensations, and sounds. The kitchen is therefore the sensory space par excellence, where rationality and emotion meet, and function and aesthetics are in perfect balance.

KITCHENS

Poliform propone cucine esclusive, capaci di cogliere le esigenze e i gusti di un pubblico eterogeneo e internazionale, caratterizzate da un'eccezionale versatilità compositiva e dall'infinita varietà di materiali e finiture. Collezioni differenti, pur nella perfetta coerenza di stile. Sistemi cucina realizzati interamente in Italia, così da garantire un accurato controllo di tutte le fasi produttive: dalla selezione di materiali di qualità alla cura del dettaglio, attraverso la continua ricerca di affidabilità, sicurezza e durata nel tempo. Cucine per case straordinarie, in perfetta sintonia con il progetto di stile Poliform, un progetto coordinato e completo che interpreta l'arredamento come un'esperienza totale.

Poliform offers exclusive kitchens, able to capture the needs and tastes of a heterogeneous and international audience, characterised by an exceptional compositional versatility and by the infinite variety of materials and finishes. Diverse collections, despite the perfect consistency of style. Kitchen systems made entirely in Italy, so as to ensure accurate control of all stages of production: from the selection of quality materials to the attention to detail, through the continuous search for reliability, safety, and durability. Kitchens for extraordinary homes, in perfect harmony with the Poliform project of style, a coordinated and complete project that interprets furniture as a comprehensive experience.

COLLECTIONS	SHAPE	35
	PHOENIX	81
	ARTEX	117
	MY PLANET	145
	TWELVE	165
	ALEA	207
	TRAIL	277
	TECHNICAL DATA	309

SHAPE



Shape è una cucina dall'apertura a maniglia ispirata, nel design contemporaneo e nella funzionalità, alle cucine senza maniglia. È caratterizzata dal particolare profilo rientrante, all'interno del quale è inserita la maniglia vera e propria. Il profilo, che nelle colonne assume l'aspetto di una modanatura a tutta altezza, nelle basi può integrare la maniglia al centro dell'anta o lateralmente.

Shape is a kitchen with a handle opening that draws inspiration from kitchens without handles in their contemporary design and functionality. It is characterized by the peculiar recessed profile, where the actual handle is hidden inside. The profile, which in the tall units takes the shape of a full-height moulding, in the base units can integrate the handle in the middle of the door or on the side.





Qui e nelle pagine precedenti: basi con ante, cassetti ed estrattori in acciaio con maniglia integrata Shape in laccato opaco moka, fianchi in acciaio e top in acciaio steelmatt Blanco. Penisola attrezzata per la zona lavoro con piano in acciaio scotch brite Blanco e involucro rastremato con gamba di sostegno Minus in alluminio laccato goffrato moka. Sistema modulare Infinity personalizzato Poliform con moduli aspiranti luminosi, fitostimolante luminoso e luminoso con teca in vetro, finitura acciaio scotch brite e vetro extralight. Colonne con ante, cassetti ed estrattori in massello di rovere fossile e maniglia integrata Shape in laccato opaco moka.

This and previous pages: base units with doors, drawers and pull out storage baskets in steel, with moka mat lacquered integrated Shape handle, side panels and worktop in steelmatt steel Blanco. Peninsula with worktop in scotch brite steel Blanco and tapered drip edge with supporting leg Minus in moka embossed lacquered aluminium. Personalized Poliform modular system Infinity, with lighted suction module, lighted phytostimulant module and lighted module with glass case, finish scotch brite steel and extra light glass. Tall units with doors, drawers and pull out storage baskets in solid fossil oak and integrated Shape handle in mat lacquer moka.





Nelle pagine precedenti: basi con ante, cassetti ed estrattori in acciaio con maniglia integrata Shape in laccato opaco moka, fianchi in acciaio e top in acciaio steelmatt Blanco. Penisola attrezzata per la zona lavoro con piano in acciaio scotch brite Blanco e involucro rastremato con gamba di sostegno Minus in alluminio laccato goffrato moka. Sistema modulare Infinity personalizzato Poliform con moduli aspiranti luminosi, fitostimolante luminoso e luminoso con teca in vetro, finitura acciaio scotch brite e vetro extralight. Colonne con ante, cassetti ed estrattori in massello di rovere fossile e maniglia integrata Shape in laccato opaco moka. A destra: dettaglio della penisola attrezzata con piano cottura a induzione, vano con vaschette in wengé, barattoli portaspezie in ceramica e mattarello in acciaio.

Previous pages: base units with doors, drawers and pull out storage baskets in steel, with moka mat lacquered integrated Shape handle, side panels and worktop in steelmatt steel Blanco. Peninsula with worktop in scotch brite steel Blanco and tapered drip edge with supporting leg Minus in moka embossed lacquered aluminium. Personalized Poliform modular system Infinity, with lighted suction module, lighted phytostimulant module and lighted module with glass case, finish scotch brite steel and extra light glass. Tall units with doors, drawers and pull out storage baskets in solid fossil oak and integrated Shape handle in mat lacquer moka. To the right: close up of the peninsula with induction hob, open compartment with wenge trays, ceramic spice jars and steel rolling pin.





Nelle pagine precedenti: basi con ante, cassetti ed estrattori in acciaio con maniglia integrata Shape in laccato opaco moka e top in acciaio steelmatt Blanco. Penisola con piano in acciaio scotch brite Blanco attrezzata con piani cottura a induzione e a gas Pitt Cooking® con manopola personalizzata Poliform, griglia poggiapentole in acciaio, tagliere in noce nazionale con finitura a olio, portamestoli in vetro, piano in dektion nero ad uso tagliere, lavello saldato Blanco e supporto porta coltelli in wengé. Sotto: base con anta in acciaio e maniglia integrata Shape in laccato opaco moka. Integrati nel piano penisola, tagliere in noce nazionale con finitura a olio e griglia poggiapentole in acciaio. A destra: dettaglio del cassetto in acciaio con maniglia integrata Shape in laccato opaco moka. Attrezzatura interna in laminato military touch e alluminio anodizzato, portaspezie in ceramica.

Previous pages: base units with doors, drawers and pull out storage baskets in steel, with moka mat lacquered integrated Shape handle, and worktop in steelmatt steel Blanco. Peninsula with top in scotch brite steel Blanco accessorized with induction and gas hob Pitt Cooking® with Poliform personalized control knob, steel pans support grid, chopping board in Italian walnut with oil finish, ladle-holder in glass, worktop in dektion nero to be used as chopping board, Blanco welded sink and knives rack in wenge. Below: base unit with door in steel and moka mat lacquered integrated handle Shape. In the peninsula worktop, integrated chopping board in Italian walnut with oil finish and steel pans support grid. To the right: close up of the drawer in steel with integrated handle Shape in mat lacquer moka. Inner equipment in laminate military touch and anodized aluminium, ceramic spice holder.



A destra: basi con ante, cassetti ed estrattori in acciaio con maniglia integrata Shape in laccato opaco moka, fianchi in acciaio e top in acciaio steelmatt Blanco. Penisola attrezzata per la zona lavoro con piano in acciaio scotch brite Blanco e involucro rastremato con gamba di sostegno Minus in alluminio laccato goffrato moka. Sistema modulare Infinity personalizzato Poliform con moduli aspiranti luminosi, fitostimolante luminoso e luminoso con teca in vetro, finitura acciaio scotch brite e vetro extralight. Colonne con ante, cassetti ed estrattori in massello di rovere fossile e maniglia integrata Shape in laccato opaco moka.

To the right: base units with doors, drawers and pull out storage baskets in steel, with moka mat lacquered integrated Shape handle, side panels and worktop in steelmatt steel Blanco. Peninsula with worktop in scotch brite steel Blanco and tapered drip edge with supporting leg Minus in moka embossed lacquered aluminium. Personalized Poliform modular system Infinity, with lighted suction module, lighted phytostimulant module and lighted module with glass case, finish scotch brite steel and extra light glass. Tall units with doors, drawers and pull out storage baskets in solid fossil oak and integrated Shape handle in mat lacquer moka.





Sotto: dettaglio della maniglia integrata Shape in laccato opaco moka posizionata verticalmente sulle ante delle colonne. A sinistra: dettaglio della maniglia integrata Shape in laccato opaco moka posizionata lateralmente sull'estrattore.

Below: close up of the integrated handle Shape in mat lacquer moka, mounted vertically on the tall unit doors. To the left: close up of the integrated handle Shape in mat lacquer moka, positioned laterally on the pull out storage basket.



Sotto: dettaglio della colonna con ripiani in vetro fumé con telaio in alluminio anodizzato nero. A destra: dettaglio dei cassetti interni della colonna in massello black ash.

Below: close up of the tall unit with shelves in glass fumé with frame in black anodized aluminium. To the right: close up of the inner drawers of the tall unit in solid black ash.



SHAPE

Design R&D Poliform

Basi p 1280

Strutture: nobilitato grigio perla.
 Ante, cassetti ed estrattori: acciaio.
 Maniglie: integrate Shape, laccato opaco moka.
 Fianchi: acciaio steelmatt, spessore 6 mm.
 Top: acciaio steelmatt Blanco, con telaio di supporto laccato gofrato grigio lavagna, spessore 6 mm.
 Zoccoli: laccato gofrato moka.

Penisola p 840

Piano: con vaso rastremato, in acciaio scotch brite Blanco, spessore 60 mm.
 Gamba di sostegno Minus: alluminio laccato gofrato moka.

Sistema modulare Infinity

Modulo fitostimolante luminoso con teca in vetro, luminoso con teca in vetro, luminoso e due moduli aspiranti luminosi.
 Finitura acciaio scotch brite e vetro extralight.

Colonne con forni p 640

Strutture: nobilitato grigio lavagna.
 Ante, cassetti ed estrattori: massello rovere fossile.
 Maniglie: integrate Shape, laccato opaco moka.
 Fianchi: massello rovere fossile, spessore 26 mm.
 Zoccoli: laccato gofrato moka.

Base units d 50 1/2"

Structures: grey perla melamine.
 Doors, drawers and pull-out storage baskets: steel.
 Handles: Shape integrated handle, moka mat lacquer.
 Side panels: steelmatt steel, thickness 1/4".
 Top: steelmatt steel Blanco, with grey lavagna embossed lacquered support frame, thickness 1/4".
 Plinths: moka embossed lacquer.

Penisola d 33"

Top: with tapered drip edge in scotch brite steel Blanco, thickness 2 1/4".
 Supporting leg Minus: moka embossed lacquered aluminium.

Modular system Infinity

Phytostimulant lighted module with glass case, lighted module and two lighted suction modules.
 Finish scotch brite steel and extralight glass.

Tall units with ovens d 25 1/4"

Structures: grey lavagna melamine.
 Doors, drawers and pull-out storage baskets: solid fossil oak.
 Handles: Shape integrated handle, moka mat lacquer.
 Side panels: solid fossil oak, thickness 1".
 Plinths: moka embossed lacquer.

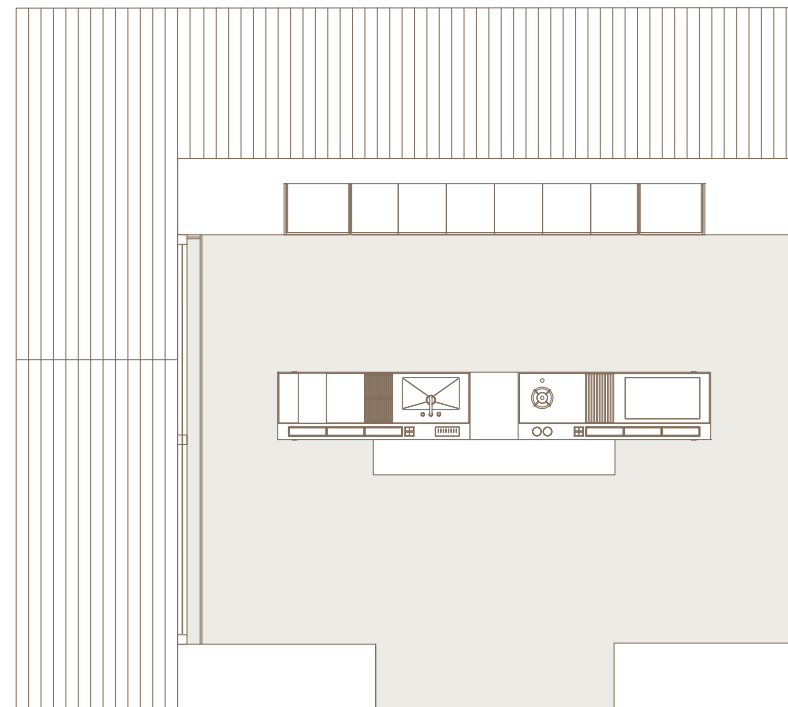
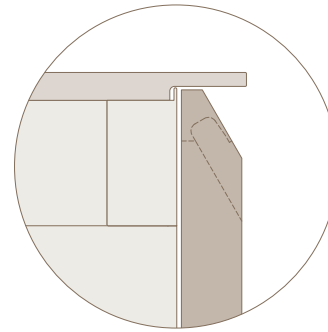

Basi con penisola Base units with peninsula

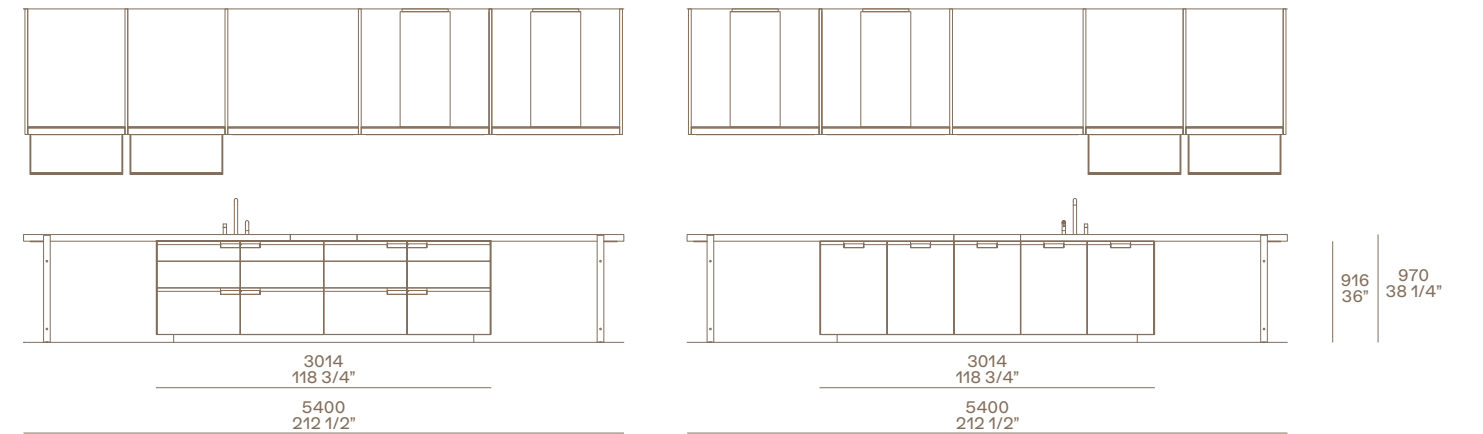

Colonne Tall units

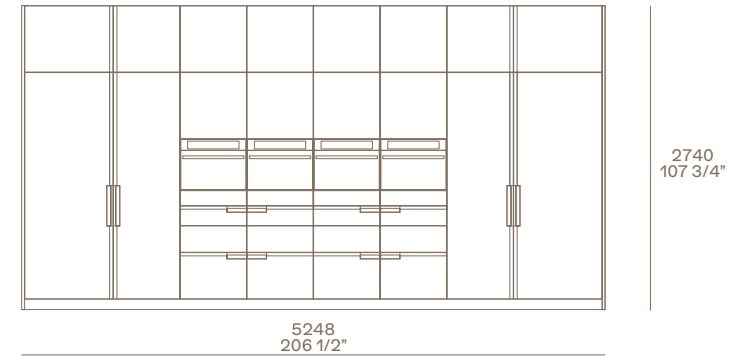

- 1 Basi con ante, cassetti ed estrattori.
- 2 Attrezzatura in laminato military touch e alluminio anodizzato.
- 3 Piano penisola con gambe di sostegno Minus.
- 4 Tagliere in noce nazionale con finitura a olio.
- 5 Gocciolatoio in PaperStone® colore nero.
- 6 Lavello saldato Blanco.
- 7 Vani con vaschette in wengé, portapelliole, barattoli portaspezie in ceramica, mattarello in acciaio.

- 8 Prese elettriche, verniciato nero.
- 9 Supporto portacoltelli in wengé.
- 10 Piano in dektion nero ad uso tagliere.
- 11 Piano cottura a gas Pitt Cooking® con manopola personalizzata Poliform.
- 12 Griglia poggiapentole in acciaio.
- 13 Piano cottura a induzione.
- 14 Portamestoli in vetro.
- 15 Sistema modulare Infinity, personalizzato Poliform.
- 16 Infinity, modulo fitostimolante luminoso con teca in vetro.

- 17 Infinity, modulo luminoso con teca in vetro.
- 18 Infinity, modulo luminoso.
- 19 Infinity, modulo aspirante luminoso.
- 20 Colonne con forni e frigoriferi, ante ad apertura battente, cassetti, estrattori e ante superiori con apertura a scatto.
- 21 Cassetti interni in massello black ash e ripiani in vetro fumé con telaio alluminio anodizzato nero.

- 1 Base units with doors, drawers and pull-out storage baskets.
- 2 Equipment in laminate military touch and anodized aluminium.
- 3 Peninsula top with supporting legs Minus.
- 4 Chopping board in Italian walnut with oil finish.
- 5 Drip tray in PaperStone® black colour.
- 6 Soldered sink Blanco.
- 7 Open compartments with basins in wenge, protective film-racks, spice holders in ceramic, steel rolling pin.

- 8 Electric sockets, black painted.
- 9 Knife rack in wenge.
- 10 Dekton top used as chopping board.
- 11 Gas hob Pitt Cooking® with Poliform personalized control.
- 12 Pan support grid in steel.
- 13 Induction hob.
- 14 Ladle-holder in glass.
- 15 Poliform personalized modular system Infinity.
- 16 Infinity, phytostimulant lighted module with glass case.

- 17 Infinity, lighted module with glass case.
- 18 Infinity, lighted module.
- 19 Infinity, lighted suction module.
- 20 Tall units with ovens and refrigerators, doors with leaf opening, drawers, pull-out storage baskets and upper doors with push-pull opening.
- 21 Inner drawers in solid black ash and shelves in fumé glass with black anodized aluminium frame.

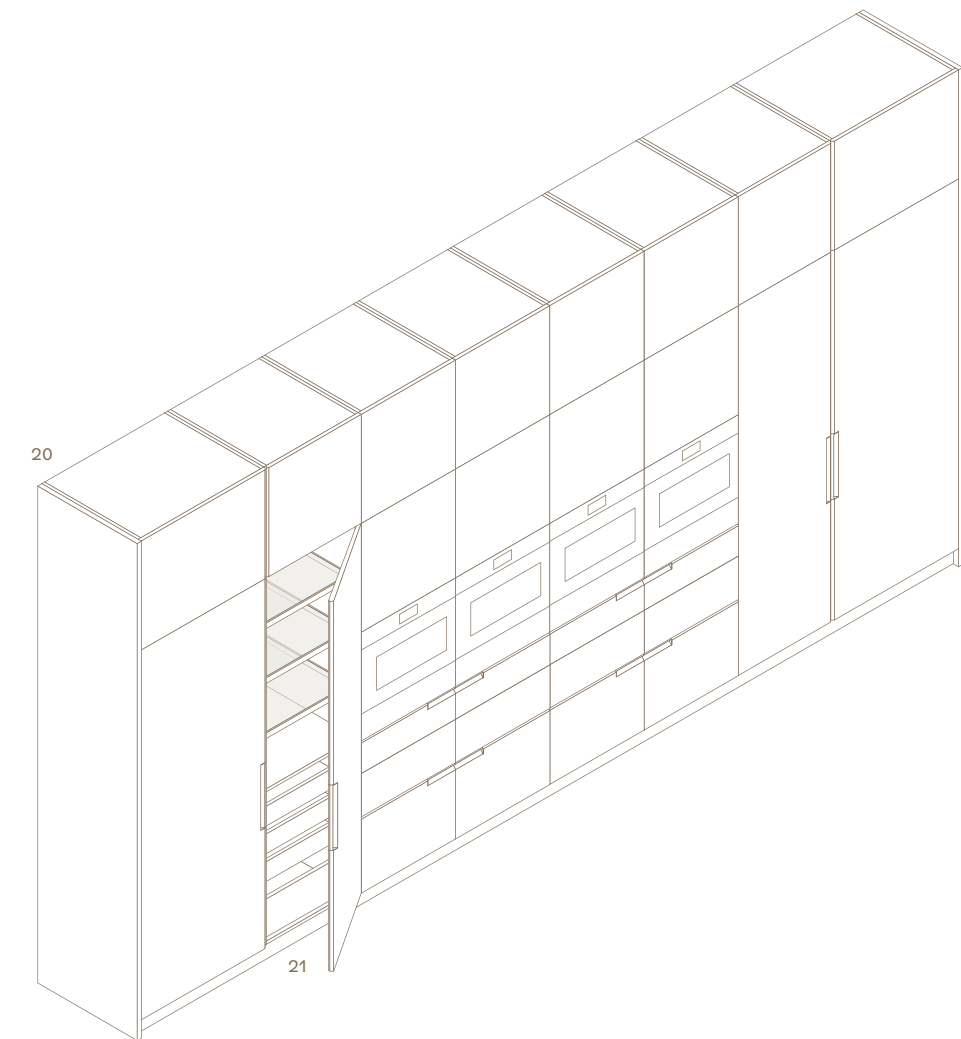
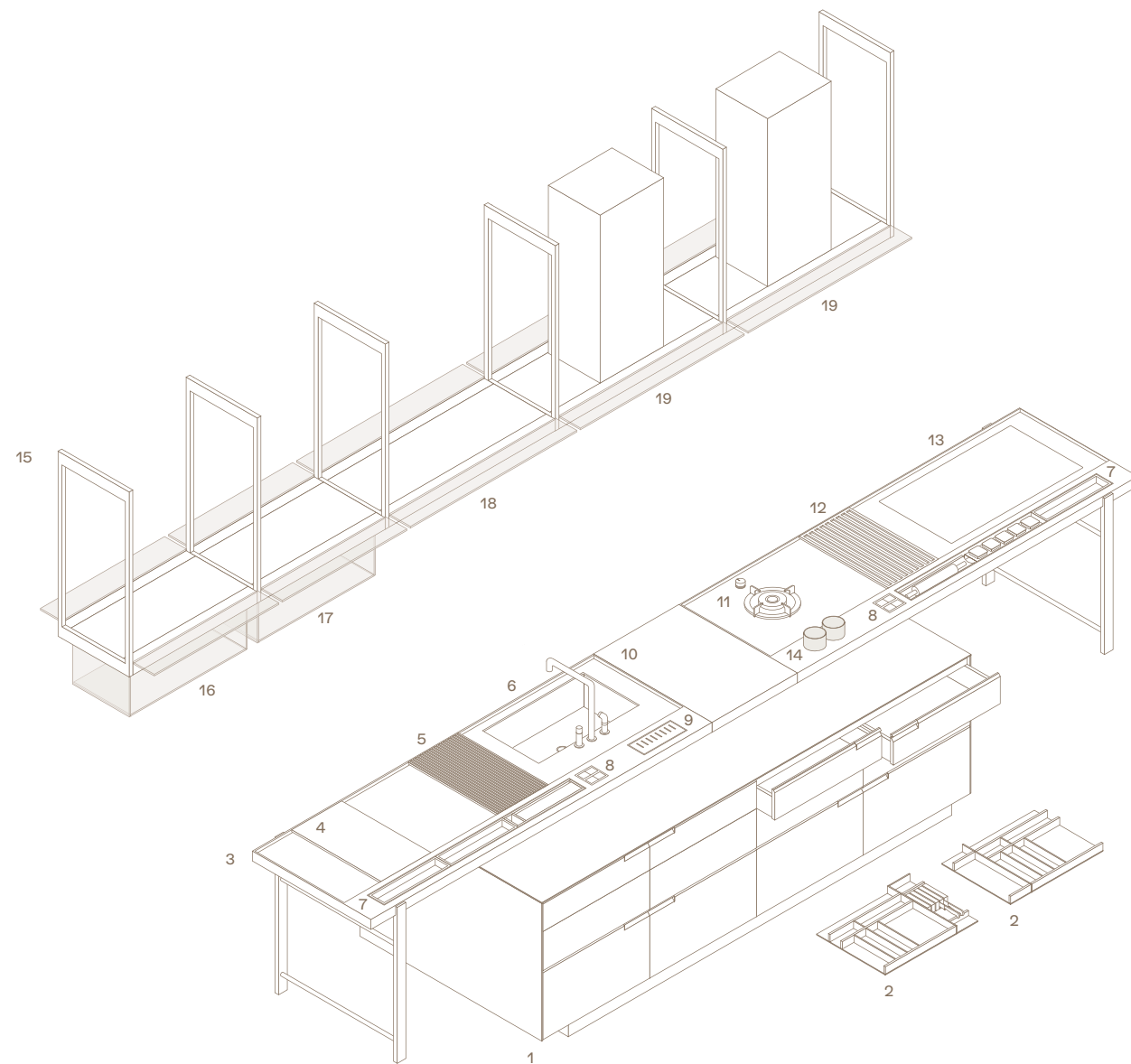

A destra: basi con ante, cassetti ed estrattori e colonne High in laccato lucido tortora con maniglia integrata Shape in laccato metallico bronzo, top in marmo lucido emperador extra dark. Sistema modulare Infinity personalizzato Poliform con modulo aspirante luminoso, luminoso e luminoso con teca in vetro, finitura acciaio scotch brite e vetro extralight. Tavolino Dama in massello noce canaletto.

To the right: base units with doors, drawers and pull out storage baskets and High tall units in tortora glossy lacquer with integrated Shape handle in bronze metallic lacquer, worktop in glossy marble emperador extra dark. Poliform personalized modular system Infinity, with lighted suction module, lighted module and lighted module with glass case, finish scotch brite steel and extra light glass. Dama coffee table in solid walnut canaletto.

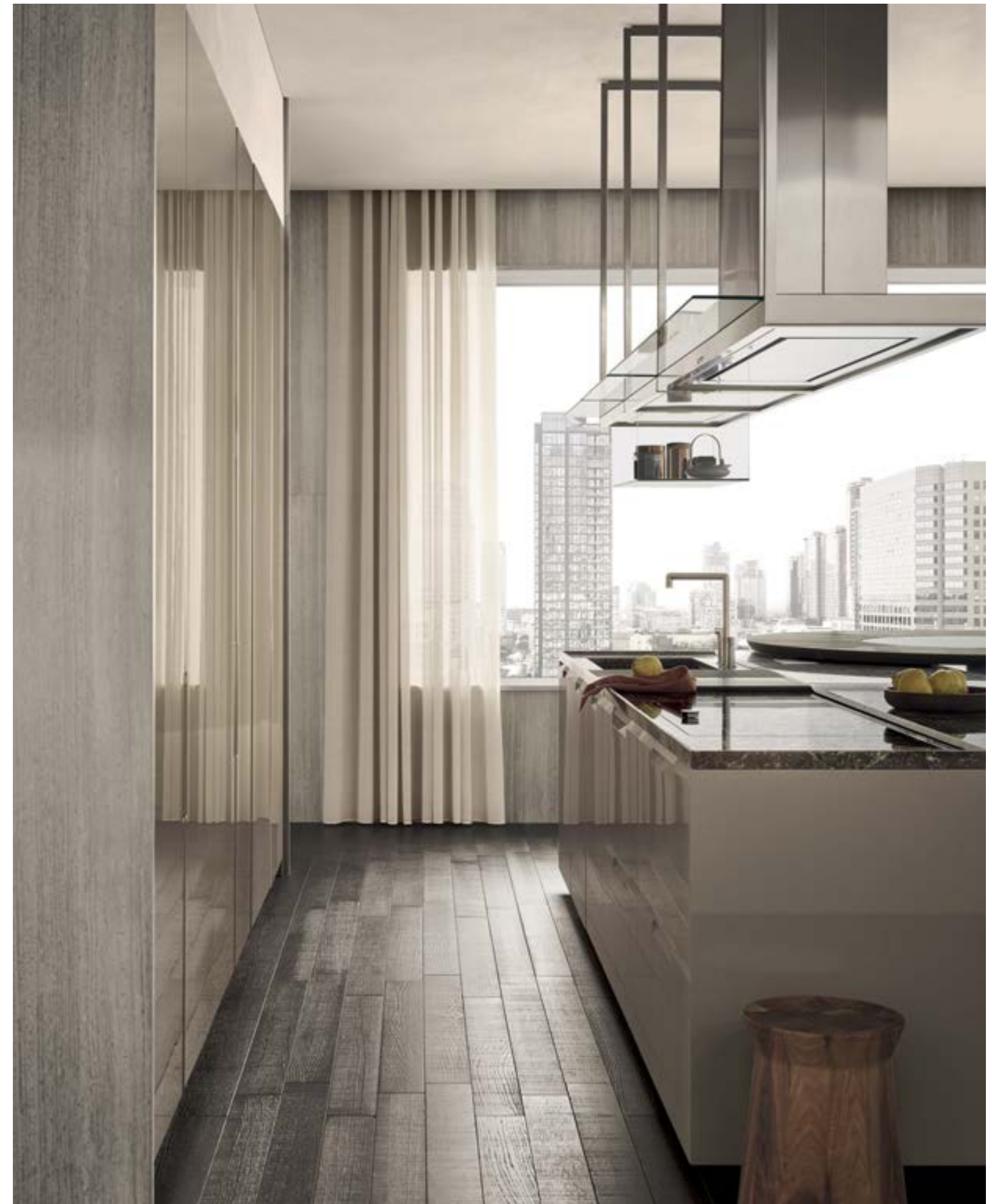



Qui e nelle pagine precedenti: basi con ante, cassetti ed estrattori e colonne High in laccato lucido tortora con maniglia integrata Shape in laccato metallico bronzo, top in marmo lucido emperador extra dark. Piano snack Moon in massello rovere fossile con piano centrale girevole integrato in marmo lucido emperador extra dark. Sgabelli Sophie in olmo nero con poggiatesta in brown nickel opaco e inserto in inox satinato, seduta con rivestimento non sfoderabile in pelle Soft 03 nocciola. Sistema modulare Infinity personalizzato Poliform con modulo aspirante luminoso, luminoso e luminoso con teca in vetro, finitura acciaio scotch brite e vetro extralight. Tavolino Dama in massello noce canaletto.

This and previous pages: base units with doors, drawers and pull out storage baskets and High tall units in tortora glossy lacquer with integrated Shape handle in bronzo metallic lacquer, worktop in glossy marble emperador extra dark. Moon snack top in solid fossil oak with integrated central swivel top in glossy marble emperador extra dark. Sophie stools in black elm with footrest in mat brown nickel and inlay in brushed steel, seat with non-removable cover in leather Soft 03 nocciola. Poliform personalized modular system Infinity, with lighted suction module, lighted module and lighted module with glass case, finish scotch brite steel and extra light glass. Dama coffee table in solid walnut canaletto.





A sinistra: dettaglio della base con cassetti ed estrattori in laccato lucido tortora con maniglia integrata Shape in laccato metallico bronzo, top in marmo lucido emperador extra dark. Sotto: dettaglio dell'estrattore in laccato lucido tortora con maniglia integrata Shape in laccato metallico bronzo e dell'attrezzatura in wengé e acciaio, luce a led integrata.

To the left: close up of the base unit with drawers and pull-out storage baskets in tortora glossy lacquer with integrated handle Shape in bronzo metallic lacquer, worktop in glossy marble emperador extra dark. Below: close up of the pull-out storage basket in tortora glossy lacquer with integrated handle Shape in bronzo metallic lacquer and of the equipment in wenge and steel, integrated led light.







Nelle pagine precedenti: basi con ante, cassetti ed estrattori e colonne High in laccato lucido tortora con maniglia integrata Shape in laccato metallico bronzo, top in marmo lucido emperador extra dark. Piano snack Moon in massello rovere fossile con piano centrale girevole integrato in marmo lucido emperador extra dark. Sgabelli Sophie in olmo nero con poggiatesta in brown nickel opaco e inserto in inox satinato, seduta con rivestimento non sfoderabile in pelle Soft 03 nocciola. Sistema modulare Infinity personalizzato Poliform con modulo aspirante luminoso, luminoso e luminoso con teca in vetro, finitura acciaio scotch brite e vetro extralight. Tavolino Dama in massello noce canaletto. A sinistra: dettaglio della colonna attrezzata con piano estraibile e cassetto in acciaio, attrezzatura interna in alluminio. Sotto: dettaglio del piano snack Moon in massello rovere fossile con piano centrale girevole integrato in marmo lucido emperador extra dark.

Previous pages: base units with doors, drawers and pull out storage baskets and High tall units in tortora glossy lacquer with integrated Shape handle in bronze metallic lacquer, worktop in glossy marble emperador extra dark. Moon snack top in solid fossil oak with integrated central swivel top in glossy marble emperador extra dark. Sophie stools in black elm with footrest in mat brown nickel and inlay in brushed steel, seat with non-removable cover in leather Soft 03 nocciola. Poliform personalized modular system Infinity, with lighted suction module, lighted module and lighted module with glass case, finish scotch brite steel and extra light glass. To the left: close up of the accessorized tall unit with pull-out top and drawer in steel, inner equipment in aluminium. Below: close up of the snack top Moon in solid fossil oak with integrated central swivel top in glossy marble emperador extra dark.





Nelle pagine precedenti: basi con ante, cassetti ed estrattori e colonne High in laccato lucido tortora con maniglia integrata Shape in laccato metallico bronzo. Top in marmo lucido emperador extra dark attrezzato con piano cottura a induzione, tagliere in polietilene nero, griglia in PaperStone® nero, lavello integrato, prese elettriche in verniciato nero. Piano snack Moon in massello rovere fossile con piano centrale girevole integrato in marmo lucido emperador extra dark. Sgabello Sophie in olmo nero con seduta con rivestimento non sfoderabile in pelle Soft 03 nocciola. A destra: colonna High con ante a scomparsa attrezzata con forni e ripiani, luce a led integrata.

Previous pages: base units with doors, drawers and pull out storage baskets and High tall units in tortora glossy lacquer with integrated handle Shape in bronze metallic lacquer. Worktop in glossy marble emperador extra dark accessorized with induction hob, chopping board in black polyethylene, grid in black PaperStone®, integrated sink, black painted electrical outlets. Moon snack top in solid fossil oak with integrated central swivel top in glossy marble emperador extra dark. Sophie stool in black elm with seat with non-removable cover in leather Soft 03 nocciola. To the right: High tall unit with pocket doors, accessorized with ovens and shelves, integrated led light.



SHAPE

Design R&D Poliform

Basi p 1280

Strutture: nobilitato grigio lavagna.
 Ante, cassetti ed estrattori: laccato lucido tortora.
 Maniglie: integrate Shape, laccato metallico bronzo.
 Fianchi: laccato lucido tortora, spessore 6 mm.
 Top: marmo lucido emperador extra dark, spessore 40 mm.
 Zoccoli: laccato gofrato moka.

Snack Ø 1800

Moon: massello rovere fossile, piano centrale marmo lucido emperador extra dark.

Sistema modulare Infinity

Modulo aspirante luminoso, luminoso e luminoso con teca in vetro. Finitura acciaio scotch brite e vetro extralight.

Colonne High p 740

Strutture: nobilitato grigio lavagna.
 Ante: laccato lucido tortora.
 Maniglie: integrate Shape, laccato metallico bronzo.
 Fianchi: laccato lucido tortora, spessore 26 mm.
 Zoccoli: laccato gofrato moka.

Complementi

Sgabello Sophie: olmo nero e pelle non sfoderabile Soft 03 nocciola.
 Tavolino Dama: massello noce canaletto.

Base units d 50 1/2"

Structures: grey lavagna melamine.
 Doors, drawers and pull-out storage baskets: tortora glossy lacquer.
 Handles: integrated Shape handle, bronzo metallic lacquer.
 Side panels: tortora glossy lacquer, thickness 6 mm.
 Top: glossy marble emperador extra dark, thickness 40 mm.
 Plinths: moka embossed lacquer.

Snack Ø 70 3/4"

Moon: solid fossil oak, central top glossy marble emperador extra dark.

Modular system Infinity

Lighted suction module, lighted module and lighted module with glass case. Finish scotch brite steel and extralight glass.

High tall units d 29 1/4"

Structures: grey lavagna melamine.
 Doors: tortora glossy lacquer.
 Handles: integrated Shape handles, bronzo metallic lacquer.
 Side panels: tortora glossy lacquer, thickness 26 mm.
 Plinths: moka embossed lacquer.

Accessories

Sophie stool: black elm and non-removable leather Soft 03 nocciola.
 Dama coffee table: solid walnut canaletto.

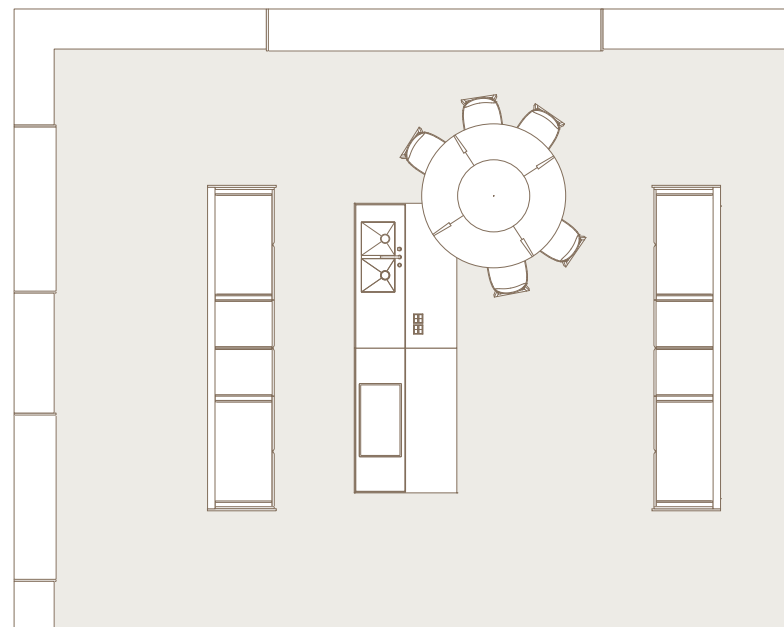
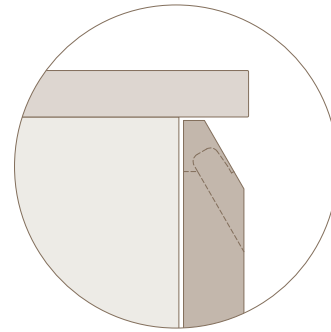

Basi Base units

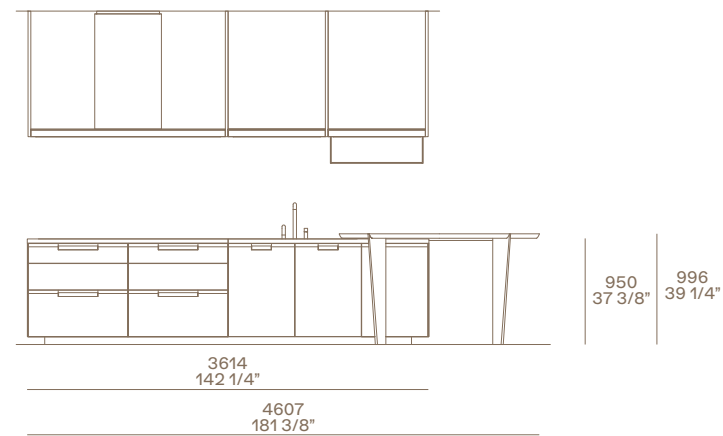

Colonne Tall units

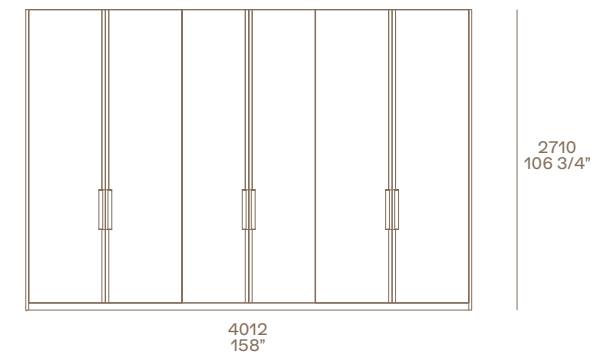

Colonne Tall units

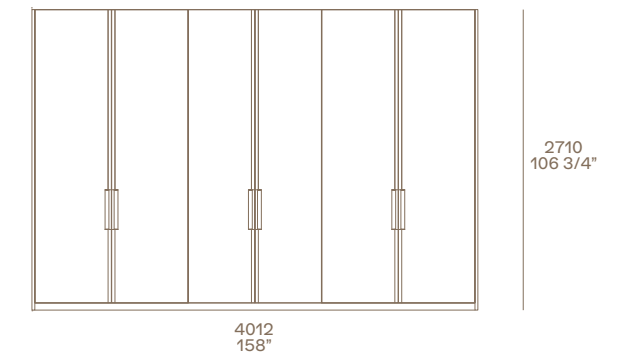

Sophie

Design Emmanuel Gallina

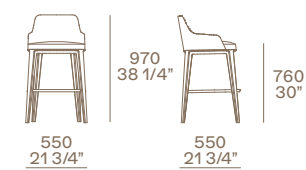

Dama

Design R&D Poliform



- 1 Basi con ante, cassetti ed estrattori.
- 2 Attrezzatura in wengé e acciaio.
- 3 Snack Moon, diametro 1800.
- 4 Piano cottura a induzione.
- 5 Tagliere in polietilene colore nero.
- 6 Gocciolatoio in PaperStone® colore nero.

- 7 Lavello integrato in marmo.
- 8 Prese elettriche, verniciato nero.
- 9 Sistema modulare Infinity, personalizzato Poliform.
- 10 Infinity, modulo aspirante luminoso.
- 11 Infinity, modulo luminoso.
- 12 Infinity, modulo luminoso con teca in vetro.

- 13 Colonne High, laterali con ante a scomparsa, centrali con ante ad apertura battente.
- 14 Colonna attrezzata con forni e ripiani.
- 15 Colonna attrezzata con piano di lavoro estraibile e cassetti in acciaio.
- 16 Attrezzatura cassetti in alluminio.

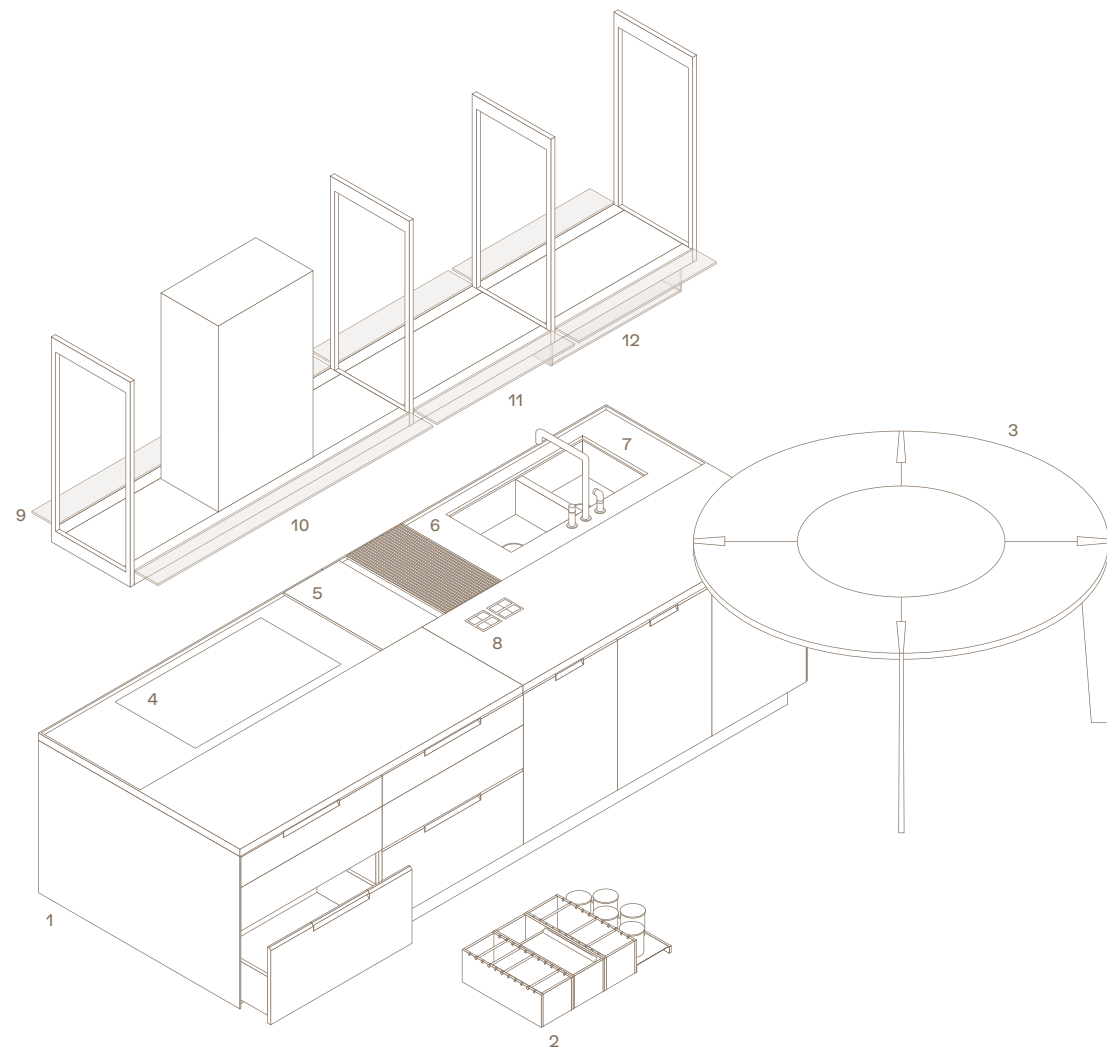

- 1 Base units with doors, drawers and pull-out storage baskets.
- 2 Equipment in wenge and steel.
- 3 Snack Moon, diameter 70 3/4".
- 4 Induction hob.
- 5 Chopping board in polyethylene black colour.
- 6 Drip tray in PaperStone® black colour.

- 7 Integrated sink in marble.
- 8 Electric sockets, black painted.
- 9 Poliform personalized modular system Infinity.
- 10 Infinity, lighted suction module.
- 11 Infinity, lighted module.
- 12 Infinity, lighted module with glass case.

- 13 High tall units, lateral with pocket doors, central units with leaf opening.
- 14 Accessorized tall unit with ovens and shelves.
- 15 Accessorized tall unit with pull-out worktop and drawers in steel.
- 16 Drawers accessories in aluminium.

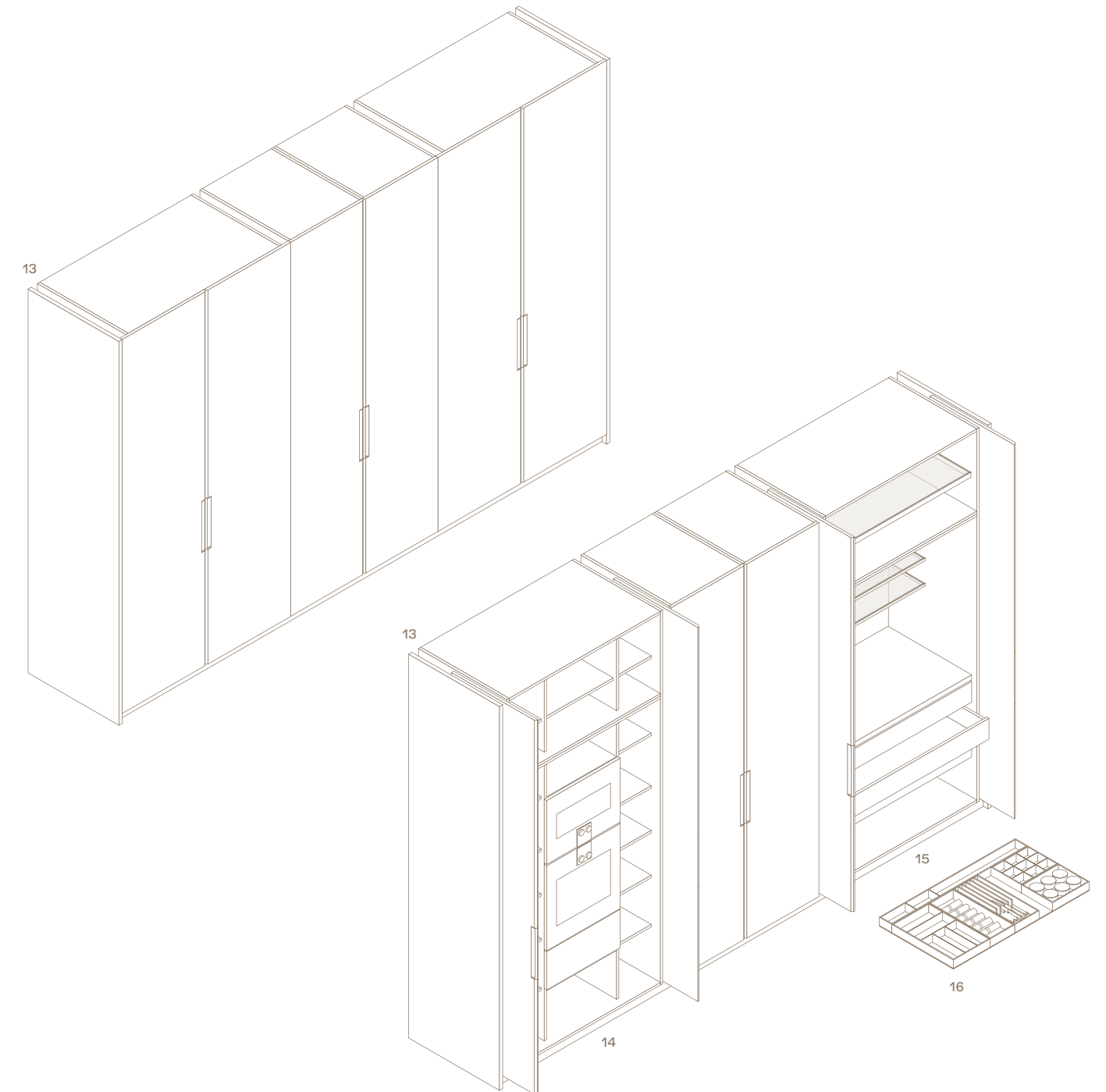

PHOENIX

Da un'intuizione progettuale di Poliform nasce Phoenix, una cucina caratterizzata dal particolare disegno dell'apertura a gola, di volta in volta personalizzato. Una soluzione innovativa, capace di trasformare un dettaglio tecnico in un dettaglio estetico che si armonizza con ogni tipologia di finitura, dall'acciaio al massello, e con tutti gli altri elementi della cucina.

From a project intuition of Poliform arises Phoenix, a kitchen characterised by the particular design of the groove opening, customised each time. An innovative solution, able to transform a technical detail into an aesthetic detail that harmonises with every type of finish, from steel to solid wood, and with all the other elements of the kitchen.

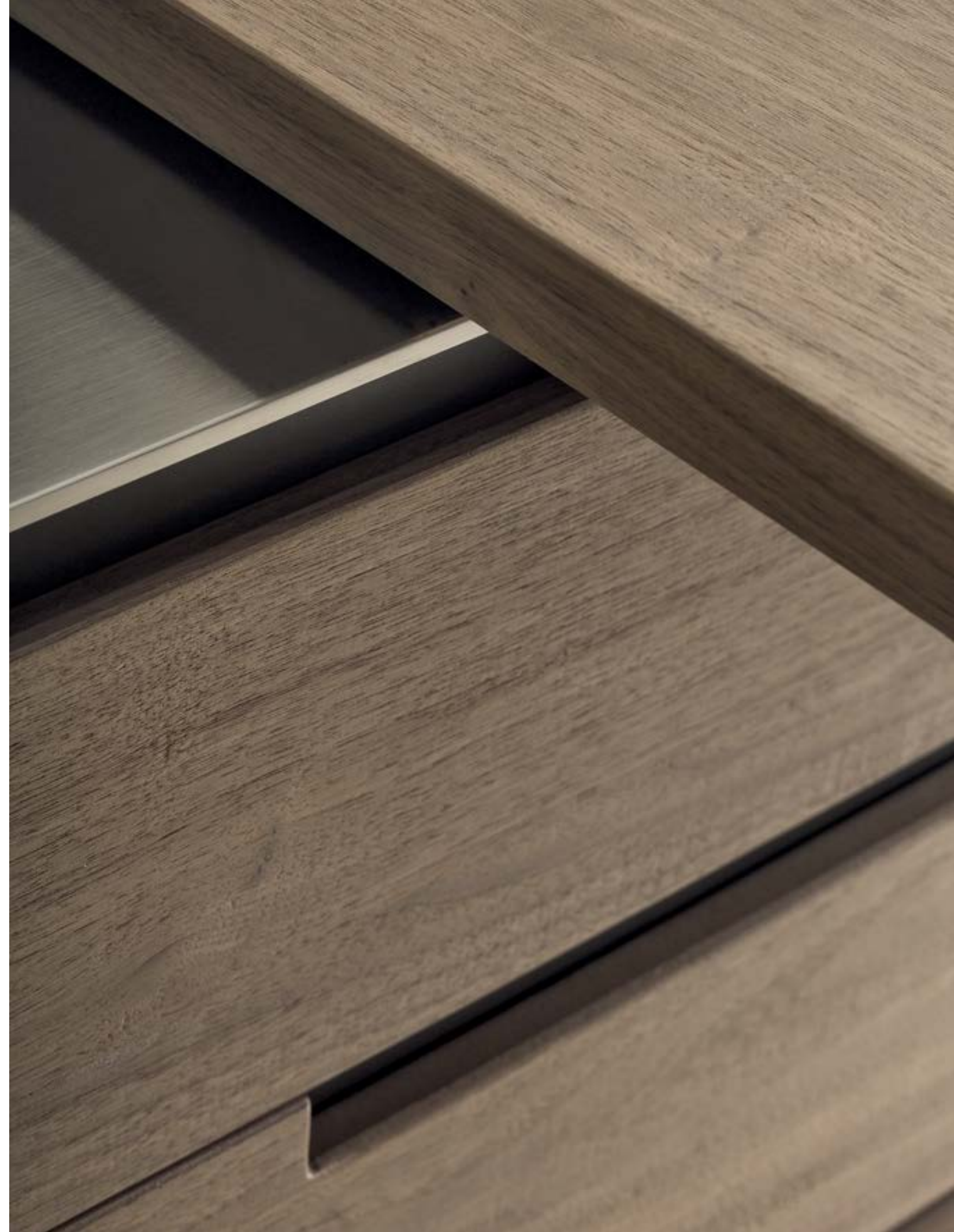



Qui e nelle pagine precedenti: basi con ante, cassetti ed estrattori in acciaio scotch brite e sagoma frontale in laccato goffrato carbone. Cappa Factory a isola in acciaio scotch brite. Colonne High con ante in olmo nero e distanziatori verticali in laccato goffrato carbone. La colonna a sinistra ha ante a scomparsa e vano attrezzato con Shaker portabicchieri, ripiani in alluminio anodizzato moka e schienale in olmo nero. In appoggio sulle basi, piano snack Blade in olmo nero. Sgabelli Ventura in olmo nero con seduta rivestita in pelle non sfoderabile Soft 4 cognac. Tavolino Dama in legno massello noce canaletto.

This and previous pages: base units with doors, drawers and pull-out storage baskets in scotch brite steel and front profile in embossed lacquered carbone. Factory island-hood in scotch brite steel. High tall units with doors in black elm and vertical spacers in embossed lacquered carbone. The tall unit on the left has pocket doors and an equipped compartment with Shaker cup holder, shelves in moka anodized aluminium and back panel in black elm. On the base units is the Blade snack top in black elm. Ventura stools in black elm with seat covered in non-removable leather Soft 4 cognac. Dama small table in solid walnut canaletto.





A sinistra: basi con ante, cassetti ed estrattori in acciaio scotch brite e sagoma frontale in laccato goffrato carbone. Cappa Factory a isola in acciaio scotch brite. Colonne High con ante in olmo nero e distanziatori verticali in laccato goffrato carbone. Tavolino Dama in legno massello noce canaletto. Sotto: dettaglio della base con cassetti. Frontale in acciaio scotch brite, piano in acciaio scotch brite KitchenAid con telaio di supporto in laccato goffrato carbone, fianco di finitura in acciaio scotch brite.

To the left: base units with doors, drawers and pull-out storage baskets in scotch brite steel and front profile in embossed lacquered carbone. Factory island-hood in scotch brite steel. High tall units with doors in black elm and vertical spacers in embossed lacquered carbone. Dama small table in solid walnut canaletto. Below: a detail of the base unit with drawers. Front profile in scotch brite steel, top in scotch brite steel KitchenAid with embossed lacquered carbone support frame, scotch brite steel on the side.







Nelle pagine precedenti: basi con ante, cassetti ed estrattori in acciaio scotch brite e sagoma frontale laccato goffrato carbone, piano in acciaio scotch brite KitchenAid con telaio di supporto laccato goffrato carbone. Cappa Factory a isola in acciaio scotch brite. Colonne High con ante in olmo nero e distanziatori verticali in laccato goffrato carbone. Piano snack Blade in olmo nero e sgabelli Ventura in olmo nero con seduta rivestita in pelle non sfoderabile Soft 4 cognac. A sinistra: dettaglio dell'attrezzatura per cassetti con portaposate in wengé, bilancia elettronica in acciaio e contenitori in ceramica. Sotto: dettaglio del piano cottura Pitt Cooking® a sei fuochi con manopole personalizzate Poliform.

Previous pages: base units with doors, drawers and pull-out storage baskets in scotch brite steel and the front profile in embossed lacquered carbone, top in scotch brite steel KitchenAid with embossed lacquered carbone support frame. Factory island-hood in scotch brite steel. High tall units with doors in black elm and vertical spacers in embossed lacquered carbone. Blade snack top in black elm and Ventura black elm stools with seat covered in non-removable leather Soft 4 cognac. Left: a detail of the drawer equipment with wenge cutlery, electronic steel scale and ceramic containers. Below: close up of the hob Pitt Cooking® with six burners with Poliform personalized controls.



A destra: basi con ante, cassetti ed estrattori in acciaio scotch brite e sagoma frontale in laccato goffrato carbone, piano in acciaio scotch brite KitchenAid con telaio di supporto in laccato goffrato carbone. Cappa Factory a isola in acciaio scotch brite. Colonne High con ante in olmo nero e distanziatori verticali in laccato goffrato carbone.

To the right: base units with doors, drawers and pull-out storage baskets in scotch brite steel and front profile in embossed lacquered carbone, top in scotch brite steel KitchenAid with embossed lacquered carbone support frame. Factory island-hood in scotch brite steel. High tall units with doors in black elm and vertical spacers in embossed lacquered carbone.



PHOENIX
Design R&D Poliform

Basi p 1280
Strutture: nobilitato grigio lavagna.
Ante, cassetti ed estrattori: acciaio scotch brite.
Maniglie: sagoma laccato goffrato carbone.
Fianchi: acciaio scotch brite, spessore 6 mm.
Top: acciaio scotch brite KitchenAid con telaio di supporto laccato goffrato carbone, spessore 6 mm.
Zoccoli: laccato goffrato carbone.

Snack
Blade: massello tinto olmo nero.

Colonne con forni p 640
Strutture: nobilitato grigio lavagna.
Ante: olmo nero.
Maniglie: distanziatore verticale laccato goffrato carbone.
Fianchi: olmo nero, spessore 26 mm.
Zoccoli: laccato goffrato carbone.

Colonne High p 740
Strutture: nobilitato grigio lavagna.
Ante: olmo nero.
Maniglie: distanziatore verticale laccato goffrato carbone.
Fianchi: olmo nero, spessore 26 mm.
Zoccoli: laccato goffrato carbone.

Complementi
Sgabello Ventura: struttura in olmo nero e rivestimento non sfoderabile in pelle Soft 4 cognac.
Tavolino Dama: legno massello noce canaletto.

Base units d 50 1/2"
Structures: grey lavagna melamine.
Doors, drawers and pull-out storage baskets: scotch brite steel.
Handles: profile in embossed lacquered carbone.
Side panels: scotch brite steel, thickness 1/4".
Top: scotch brite steel KitchenAid with support frame in embossed lacquered carbone, thickness 1/4".
Plinths: embossed lacquered carbone.

Snack
Blade: solid wood dyed black elm.

Tall units with ovens d 25 1/4"
Structures: grey lavagna melamine.
Doors: black elm.
Handles: vertical spacer in embossed lacquered carbone.
Side panels: black elm, thickness 1".
Plinths: embossed lacquered carbone.

High tall units d 29 1/4"
Structures: grey lavagna melamine.
Doors: black elm.
Handles: vertical spacer in embossed lacquered carbone.
Side panels: black elm, thickness 1".
Plinths: embossed lacquered carbone.

Accessories
Ventura stool: structure in black elm and non-removable cover in leather Soft 4 cognac.
Dama coffee table: solid walnut canaletto.

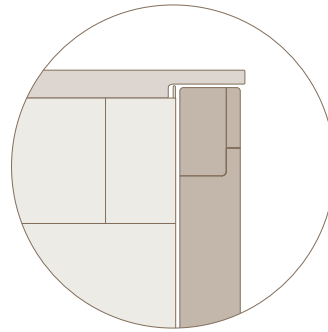

Basi
Base units

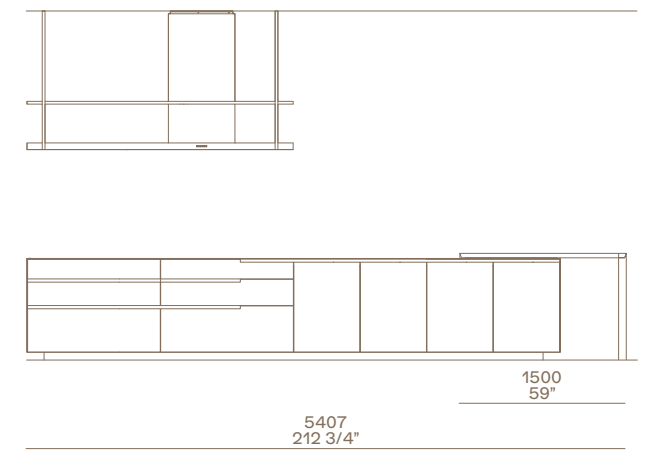
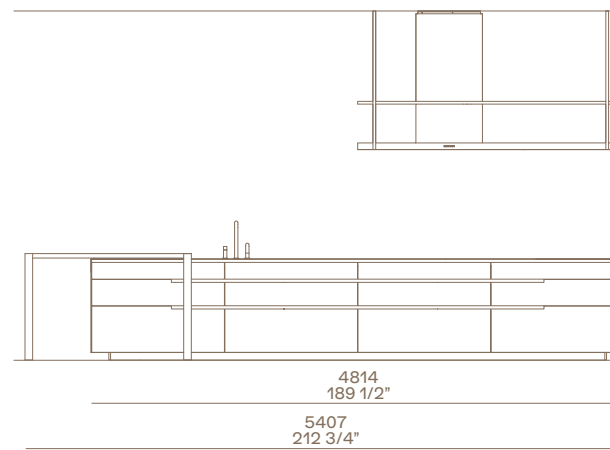

Colonne
Tall units

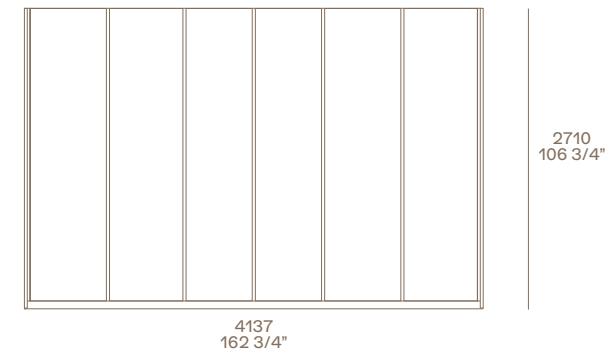

Colonne
Tall units



Ventura
Design Jean-Marie Massaud

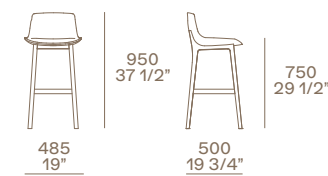

Dama
Design R&D Poliform

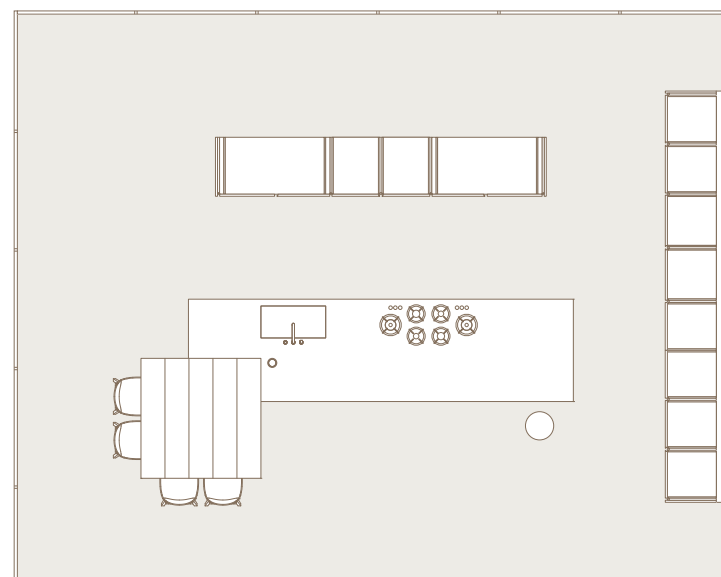

- 1 Colonne High, laterali con ante a scomparsa, colonne centrali con ante ad apertura battente. Vano attrezzato con cassetti, Shaker portacalici e ripiani.
- 2 Lavello in acciaio scotch brite saldato.

- 3 Piano cottura Pitt Cooking®, 6 fuochi, con manopole personalizzate Poliform.
- 4 Presa elettrica a scomparsa.
- 5 Attrezzatura in wengé e acciaio per cassetti ed estrattori.

- 6 Cappa Factory a isola in acciaio scotch brite, personalizzata Poliform.
- 7 Snack Blade quadrato 1500 × 1500.
- 8 Colonne High con forni e frigoriferi attrezzate con cassetti e ripiani, con ante ad apertura battente.

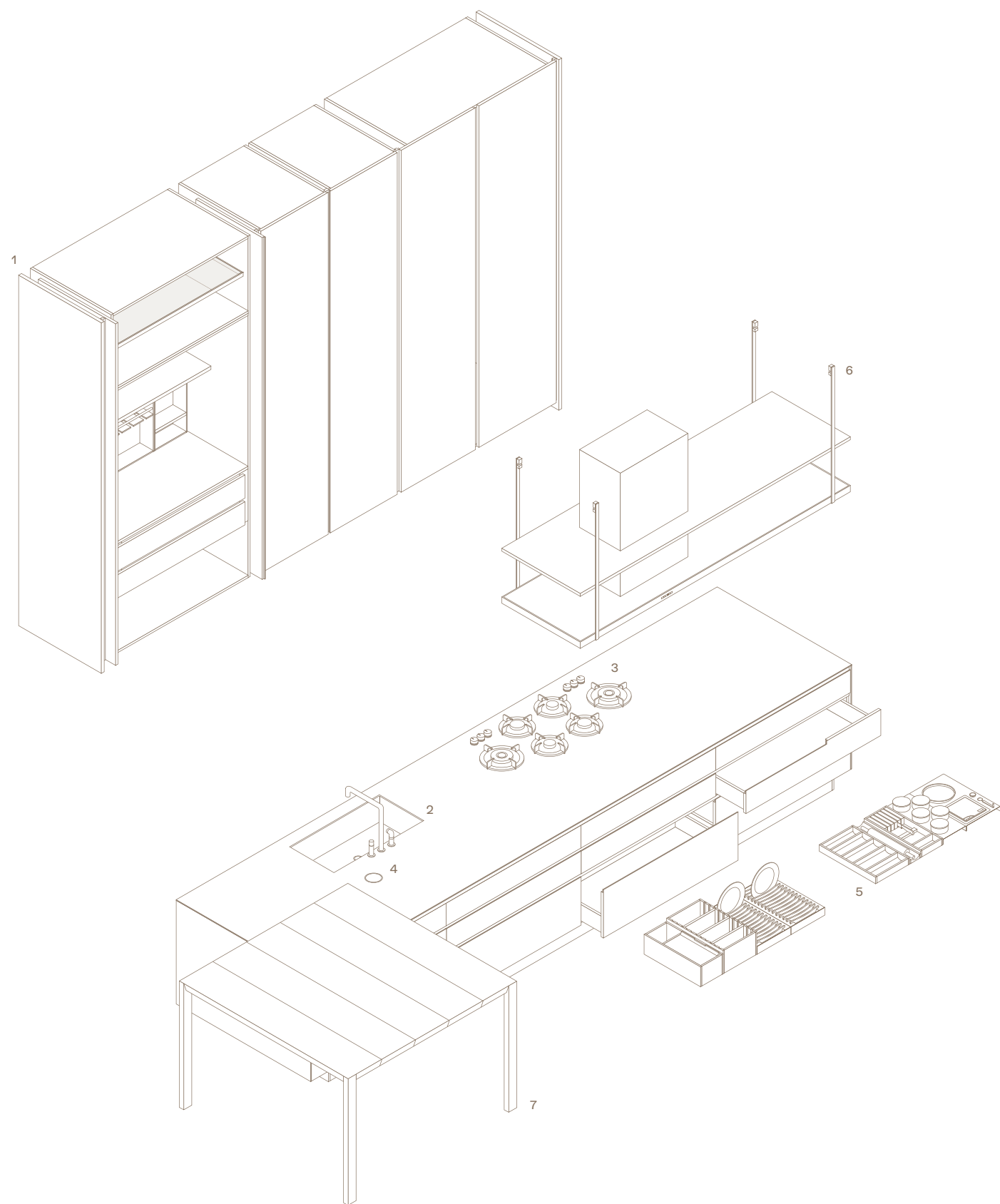

- 1 High tall units, lateral with pocket doors, central units with leaf opening. Compartment equipped with drawers, chalices rack Shaker and shelves.
- 2 Soldered scotch brite steel sink.

- 3 Hob Pitt Cooking® 6 burners, Poliform personalized controls.
- 4 Lift-up power socket.
- 5 Equipment in wenge and steel for drawers and pull-out storage baskets.

- 6 Island-hood Factory in scotch brite steel, personalized Poliform.
- 7 Square snack Blade 59" x 59".
- 8 High tall units with ovens and refrigerators, equipped with drawers and shelves, leaf doors.

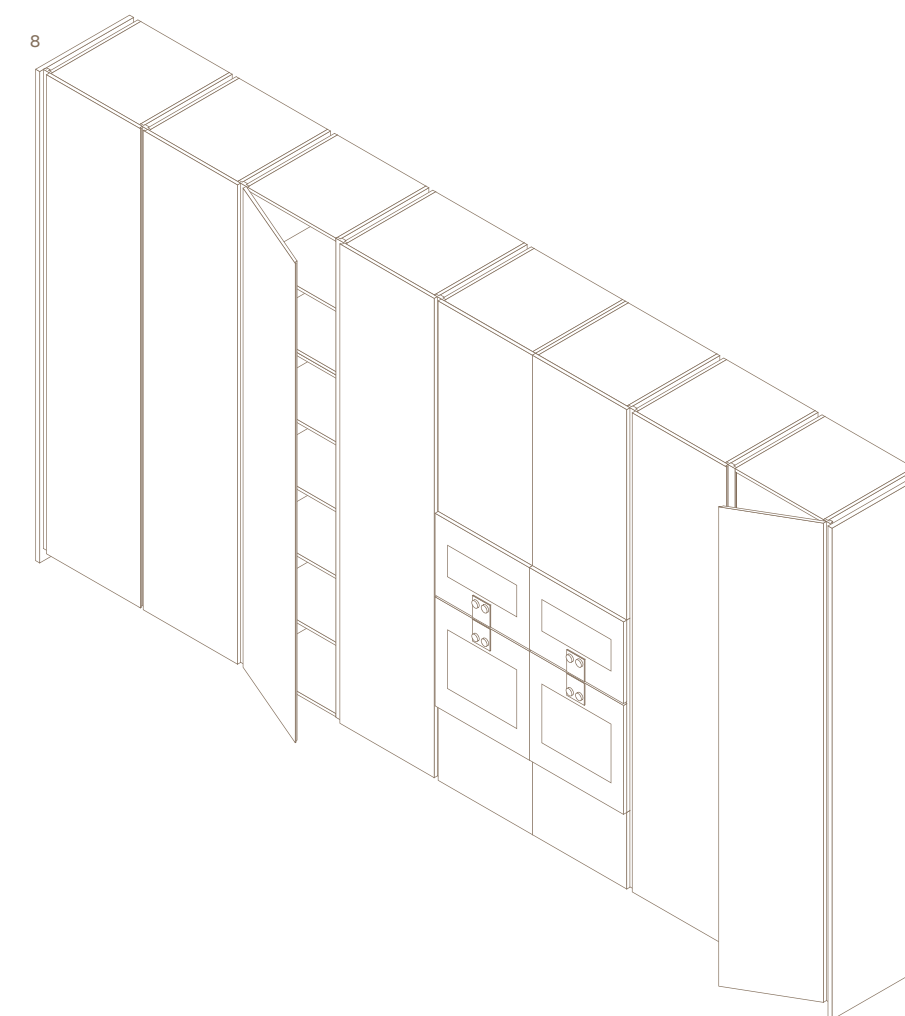

A destra: basi con ante, cassetti ed estrattori in massello noce canaletto, top in acciaio scotch brite Barazza. Cappe a isola in acciaio scotch brite. Pensili con ante vetrina PR22 in vetro riflettente fumé e profilo in alluminio anodizzato nero, mensole in laccato goffrato carbone e schienali in noce c. Colonne con ante in laccato goffrato glacier white.

To the right: base units with doors, drawers and pull-out storage baskets in walnut canaletto solid wood, top in scotch brite steel Barazza. Island-hoods in scotch brite steel. Wall units with fumé reflecting glass doors and black anodized aluminium profile PR22, shelves in embossed lacquered carbone, back panels in walnut c. Tall units with doors in embossed lacquered glacier white.





Qui e nelle pagine precedenti: basi con ante, cassetti ed estrattori in massello noce canaletto, top in acciaio scotch brite Barazza. Cappe a isola in acciaio scotch brite. Pensili con ante vetrina PR22 in vetro riflettente fumé e profilo in alluminio anodizzato nero, mensole laccato goffrato carbone, schienali in noce c. Colonne con ante in laccato goffrato glacier white. Sotto: dettaglio della particolare lavorazione che caratterizza l'apertura del modello Phoenix. Cassetto in massello noce canaletto con sistema di illuminazione interna a led. Attrezzatura in wengé e acciaio con tagliere per pane e contenitori in ceramica.

This and previous pages: base units with doors, drawers and pull-out storage baskets in walnut canaletto solid wood, top in scotch brite steel Barazza. Island-hoods in scotch brite steel. Wall units with fumé reflecting glass doors and black anodized aluminium profile PR22, shelves in embossed lacquered carbone, back panels in walnut c. Tall units with doors in embossed lacquered glacier white. Below: close-up of the special workmanship characterising the Phoenix model handle. Drawer in solid wood walnut canaletto, with inner led lighting system. Inner equipment in wenge and steel with chopping board and containers in ceramic.





A sinistra: basi con ante, cassetti ed estrattori in massello noce canaletto e sagoma frontale laccato opaco acciaio. Top in acciaio scotch brite Barazza con lavello in acciaio scotch brite saldato, piano cottura in vetroceramica a induzione con piastra Teppan Yaki. Sotto: dettaglio della presa elettrica da piano a scomparsa.

To the left: base units with doors, drawers and pull-out storage baskets in solid wood walnut canaletto and front profile in mat lacquered steel. Top in scotch brite steel Barazza with soldered sink in scotch brite steel, glass ceramic induction hob and Teppan Yaki griddle. Below: close-up view of lift-up power socket.







Qui e nelle pagine precedenti: basi con ante, cassetti ed estrattori in massello noce canaletto, top in acciaio scotch brite Barazza. Cappe a isola in acciaio scotch brite. Colonne con ante in laccato gofrato glacier white. Pensili con ante vetrina PR22 in vetro riflettente fumé e profili in alluminio anodizzato nero, mensole in laccato gofrato carbone e schienali in noce c. Tavolo Blade in massello noce canaletto, sedie Seattle con seduta in cuoio 26 invecchiato e struttura in rovere naturale. Sotto: dettaglio delle ante vetrina PR22 con apertura pieghevole in vetro riflettente fumé e profilo in alluminio anodizzato nero.

This and previous pages: base units with doors, drawers and pull-out storage baskets in solid wood walnut canaletto, top in scotch brite steel Barazza. Island-hoods in scotch brite steel. Tall units with doors in embossed lacquered glacier white. Wall units with fumé reflecting glass doors and black anodized aluminium profiles PR22, shelves in embossed lacquered carbone, back panels in walnut c. Blade table with structure and top in solid wood walnut canaletto. Seattle chairs, legs in natural oak and seat in hide 26 invecchiato. Below: close-up of folding doors PR22 in fumé reflecting glass with black anodized profiles.



PHOENIX
Design R&D Poliform

Basi p 1280
Strutture: nobilitato grigio lavagna.
Ante, cassetti ed estrattori: massello noce canaletto.
Maniglie: sagoma laccato opaco acciaio.
Fianchi: acciaio scotch brite, spessore 6 mm.
Top: acciaio scotch brite Barazza, spessore 6 mm.
Zoccoli: laccato opaco acciaio.

Colonne p 640
Strutture: nobilitato grigio lavagna.
Ante: laccato gofrato glacier white.
Maniglie: distanziatore verticale e sagoma orizzontale laccato opaco acciaio.
Fianchi: laccato gofrato glacier white, spessore 26 mm.
Zoccoli: laccato opaco acciaio.

Pensili p 410
Strutture: nobilitato grigio lavagna.
Ante vetrina PR22: profilo alluminio anodizzato nero e vetro riflettente fumé.
Maniglie: profilo.
Fianchi: laccato gofrato carbone, spessore 6 mm.
Mensole: laccato gofrato carbone, spessore 30 mm.
Schienali: noce c.

Complementi
Tavolo Blade: struttura e piano in massello noce canaletto.
Sedia Seattle: seduta in cuoio 26 invecchiato, gambe rovere naturale.

Base units d 50 1/2"
Structures: grey lavagna melamine.
Doors, drawers and pull-out storage baskets: solid wood walnut canaletto.
Handles: profile in mat lacquered steel.
Side panels: scotch brite steel, thickness 1/4".
Top: scotch brite steel Barazza, thickness 1/4".
Plinths: mat lacquered steel.

Tall units d 25 1/4"
Structures: grey lavagna melamine.
Doors: embossed lacquered glacier white.
Handles: vertical spacer and horizontal profile in mat lacquered steel.
Side panels: embossed lacquered glacier white, thickness 1".
Plinths: mat lacquered steel.

Wall units d 16 1/4"
Structures: grey lavagna melamine.
Glass doors PR22: black anodized aluminium profile and fumé reflecting glass.
Handles: profilo.
Side panels: embossed lacquered carbone, thickness 1/4".
Shelves: embossed lacquered carbone, thickness 1 1/4".
Back panels: walnut c.

Accessories
Blade table: structure and top in solid wood walnut canaletto.
Seattle chair: seat in hide 26 invecchiato and natural oak legs.

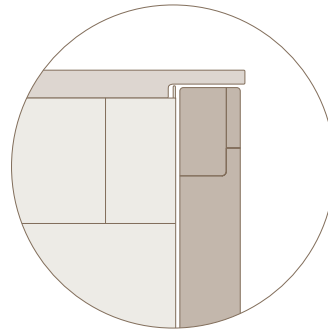

Basi
Base units

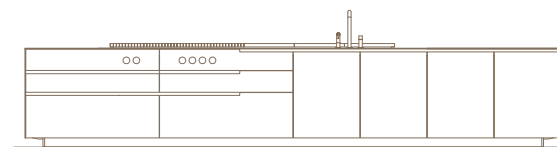
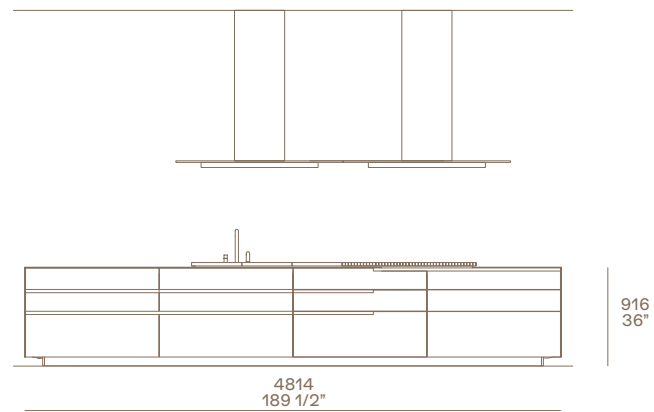

Colonne
Tall units

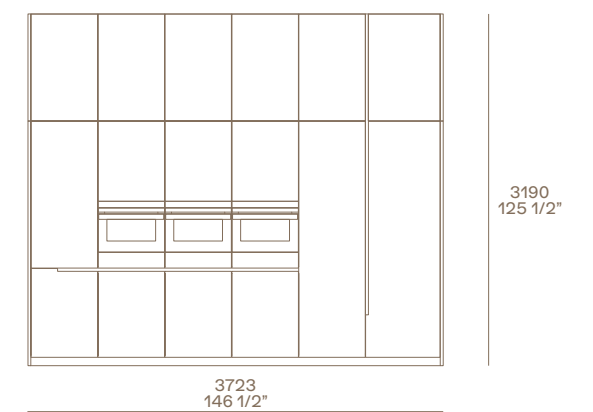

Pensili
Wall units

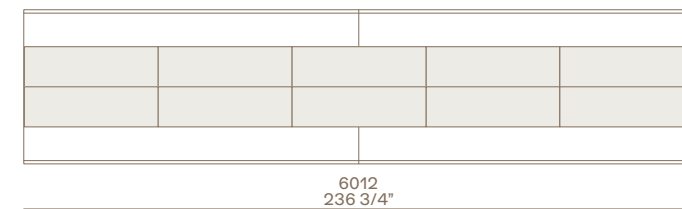

Seattle
Design Jean-Marie Massaud

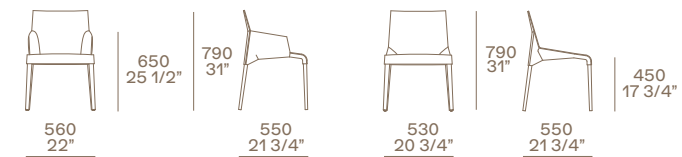

Blade
Design R&D Poliform

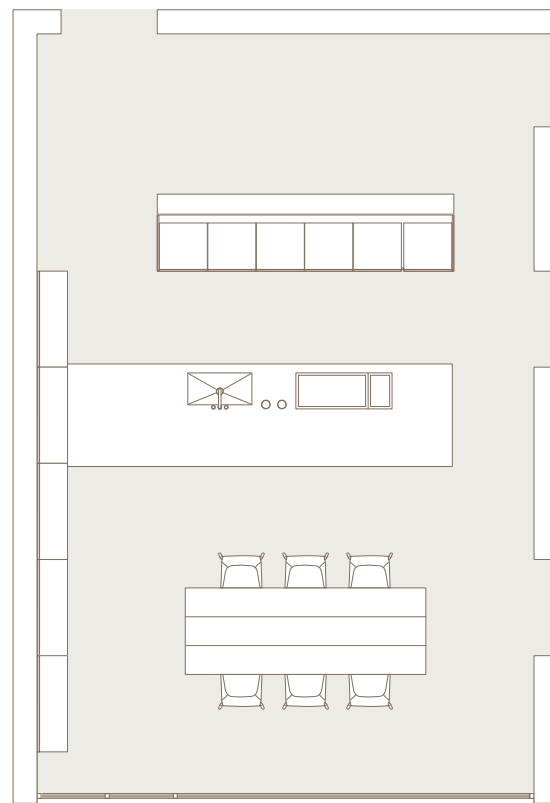
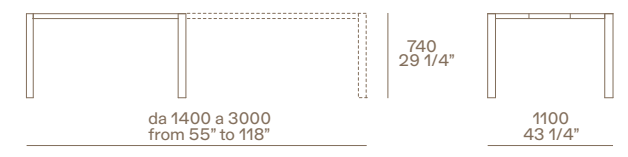

- 1 Piano cottura a induzione in vetroceramica e piastra Teppan Yaki, incasso filotop.
- 2 Lavello in acciaio scotch brite saldato.
- 3 Prese elettriche a scomparsa.
- 4 Attrezzatura cassetti in wengé e acciaio.

- 5 Attrezzatura in wengé e acciaio per estrattori.
- 6 Cappe a isola in acciaio scotch brite.
- 7 Pensili con ante vetrina PR22 con apertura pieghevole.

- 8 Colonne con forno, scaldavivande e frigo/congelatore con ante ad apertura battente ed estrattori.
- 9 Attrezzatura in wengé e acciaio per estrattori.

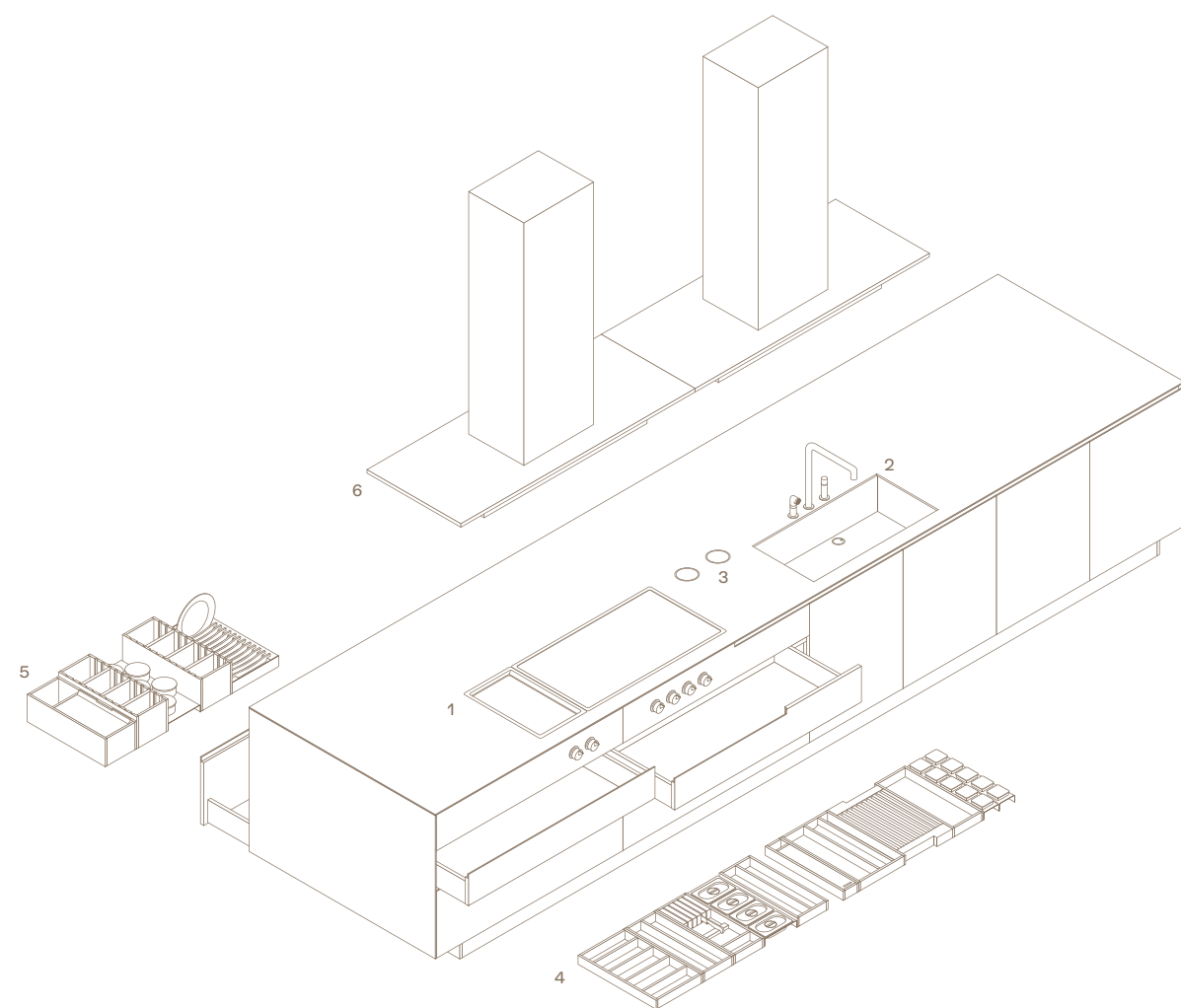

- 1 Glass ceramic induction hob and Teppan Yaki griddle, flush built-in.
- 2 Soldered sink in scotch brite steel.
- 3 Lift-up power socket.
- 4 Equipment in wenge and steel for drawers.

- 5 Equipment in wenge and steel for pull-out storage basket.
- 6 Island-hoods in scotch brite steel.
- 7 Wall units with glass doors PR22 with folding opening.

- 8 Tall units with oven, plate warmer and fridge/freezer with leaf doors and pull-out storage baskets.
- 9 Equipment in wenge and steel for pull-out storage baskets.

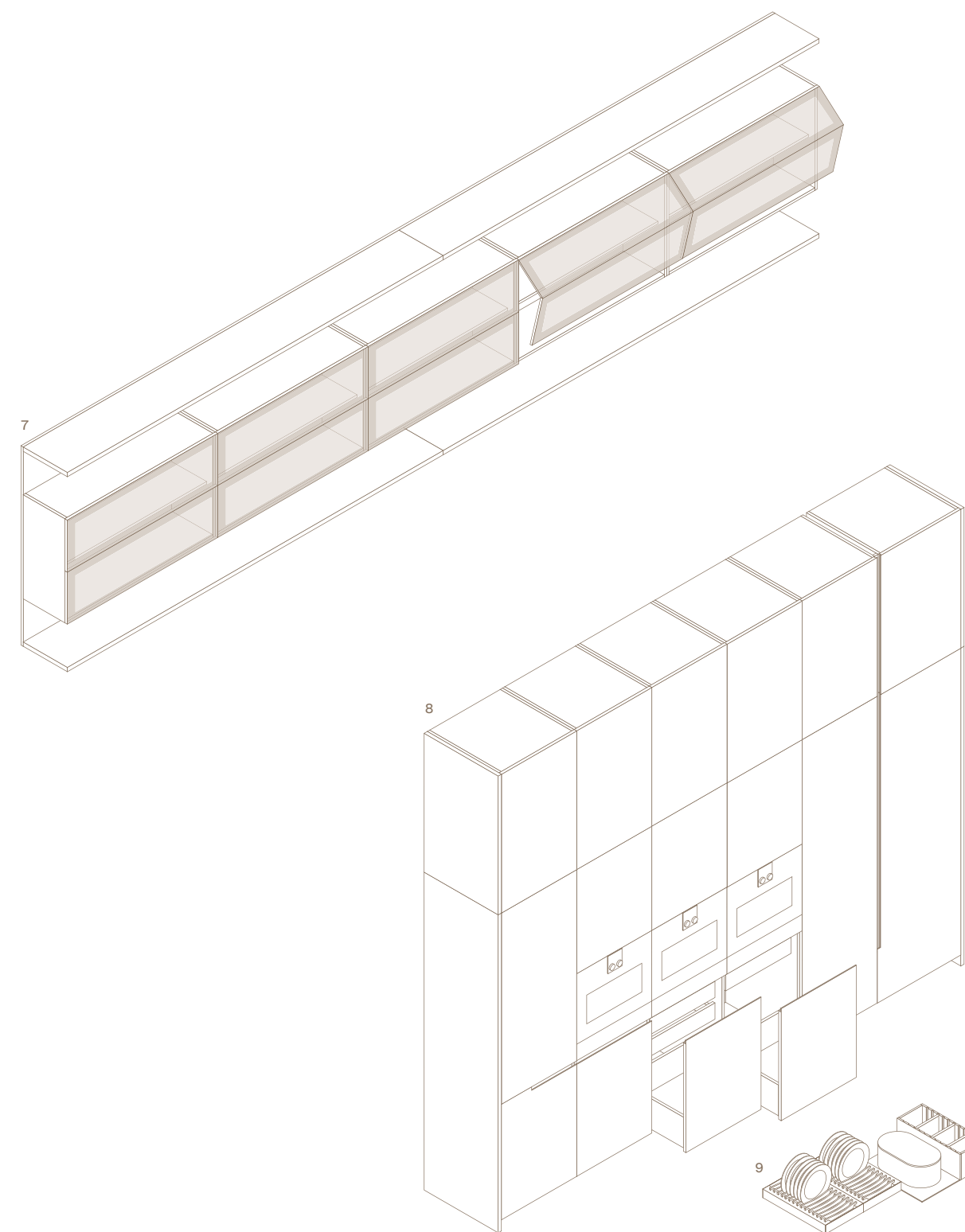

ARTEX

Per la lavorazione sartoriale che ne contraddistingue l'anta, spesso abbinata a finiture preziose o nella versione a doghe, la cucina Artex è pensata per gli ambienti più esclusivi. Il progetto, firmato Poliform, è caratterizzato dalla particolare rastrematura eseguita sull'apertura, sul fianco e sul top, così da ottenere un incastro perfetto.

For the sartorial look that marks the door, often combined with precious finishes or in the slatted version, the Artex kitchen is designed for the most exclusive environments. The project, signed Poliform, is characterised by the particular tapering performed on the opening, on the side, and on the top, so as to obtain a perfect joint.





Qui e nelle pagine precedenti: basi con ante ed estrattori in acciaio scotch brite, top in pietra fossena fiammata. Cappa Factory a isola in acciaio scotch brite. Colonne centrali con ante in laccato goffrato visone, colonne ed elementi sopra colonna con ante vetrina PR21, telaio anodizzato moka e vetro riflettente fumé. Boiserie con pannelli in olmo nero e mensole in laccato goffrato carbone.

This and previous pages: base units with doors and pull-out storage baskets in scotch brite steel, top in fossena stone blaze. Factory island-hood in scotch brite steel. Central tall units with embossed lacquered visone doors, tall units and cabinets above tall units PR21 with moka anodized frame and fumé reflecting glass doors. Black elm wall panelling and embossed lacquered carbone shelves.





A sinistra: dettaglio dell'estrattore con cassetti verniciato brown, piattaja e attrezzatura interna in noce canaletto e alluminio anodizzato moka.

To the left: close-up of pull-out storage basket with drawers painted brown, plate holder and inner drawer equipment in walnut canaletto and moka anodized aluminium.





Qui e nelle pagine precedenti: basi con ante ed estrattori in acciaio scotch brite, top in pietra fossena fiammata. Cappa Factory a isola in acciaio scotch brite. Colonne centrali con ante in laccato goffrato visone, colonne ed elementi sopracolonna con ante vetrina PR21, telaio anodizzato moka e vetro riflettente fumé. Boiserie con pannelli in olmo nero e mensole in laccato goffrato carbone. Sotto: dettaglio del piano in pietra fossena fiammata con bordo rastremato e telaio di supporto in alluminio con finitura laccato goffrato carbone.

This and previous pages: base units with doors and pull-out storage baskets in scotch brite steel and top in fossena stone blaze. Factory island-hood in scotch brite steel. Central tall units with embossed lacquered visone doors, tall units and cabinets above tall unit PR21 with moka anodized frame and fumé reflecting glass doors. Black elm wall panelling and embossed lacquered carbone shelves. Below: close-up of top in fossena stone blaze with tapered edge and supporting frame in aluminium with embossed lacquered carbone finishing.





Nelle pagine precedenti: basi con ante ed estrattori in acciaio scotch brite e top in pietra fossena fiammata. Cappa Factory a isola in acciaio scotch brite. Colonne centrali con ante in laccato goffrato visone, colonne ed elementi sopra colonna con ante vetrina PR21, telaio anodizzato moka e vetro riflettente fumé. A destra: ante vetrina PR21 con telaio anodizzato moka e vetro riflettente fumé; negli elementi sopra colonna ante ad apertura tip-on. Sotto: dettaglio della maniglia integrata nel montante del telaio.

Previous pages: base units with doors and pull-out storage baskets in scotch brite steel and top in fossena stone blaze. Factory island-hood in scotch brite steel. Central tall units with embossed lacquered visone doors, tall units and cabinets above tall unit PR21 with moka anodized frame and fumé reflecting glass doors. To the right: glass tall units PR21 with doors in fumé reflecting glass and moka anodized frame; in the elements above tall unit doors with tip-on opening. Below: close-up of handle integrated into frame upright.



A destra: dettaglio delle colonne con ante vetrina PR21, telaio anodizzato moka e vetro riflettente fumé. Ripiani interni in vetro con telaio anodizzato nero e cassettiere in olmo nero con sagome laccato opaco moka. Sotto: dettaglio della cassetiera con attrezzatura in noce canaletto e alluminio anodizzato moka.

To the right: close-up of tall units with doors PR21 with moka anodized frame and fumé reflecting glass doors. Glass inner shelves with black anodized frame and chest of drawers in black elm with profile in moka mat lacquered. Below: close-up of inner chest of drawers with equipment in walnut canaletto and moka anodized aluminium.





Qui e nelle pagine precedenti: basi con ante ed estrattori in olmo nero a doghe e top in pietra fossena fiammata. Piano cottura in acciaio scotch brite a cinque fuochi e lavello in acciaio scotch brite personalizzati Poliform by Barazza. Cappa Factory a isola in acciaio scotch brite.

This and previous pages: base units with doors and pull-out storage baskets in black elm with carved lines and top in fossena stone blaze. Personalized five burners scotch brite steel hob and sink Poliform by Barazza. Factory island-hood in scotch brite steel.



ARTEX

Design R&D Poliform

Basi p 1280

Strutture: nobilitato grigio lavagna.
Ante ed estrattori: acciaio scotch brite.
Top: pietra fossena fiammata spessore 20 mm con bordo rastremato e telaio di supporto in alluminio laccato goffrato carbone.
Zoccoli: laccato goffrato carbone.

Colonne vetrina PR21 p 640

Strutture: nobilitato grigio lavagna.
Ante: telaio anodizzato moka e vetro riflettente fumé.
Ripiani interni: vetro e telaio anodizzato nero.
Cassettiere interne: olmo nero con sagome laccato opaco moka.
Zoccoli: laccato goffrato carbone.

Colonne parte centrale

Ante e sagome orizzontali: laccato goffrato visone.

Elementi sopracolonna vetrina PR21

Ante: telaio anodizzato moka e vetro riflettente fumé.
Aperture: tip-on.
Ripiani interni: vetro con telaio anodizzato nero.

Boiserie

Pannelli: olmo nero.
Mensole: laccato goffrato carbone, spessore 3 mm.

Base units d 50 1/2"

Structures: grey lavagna melamine.
Doors and pull-out storage baskets: scotch brite steel.
Top: fossena stone blaze, thickness 3/4" with tapered edge and supporting frame in carbone embossed lacquered aluminium.
Plinths: embossed lacquered carbone.

Glass tall units PR21 d 25 1/4"

Structures: grey lavagna melamine.
Doors: anodized moka frame and fumé reflecting glass.
Inner shelves: glass with black anodized frame.
Inner chest of drawers: black elm with profile moka mat lacquered.
Plinths: embossed lacquered carbone.

Central tall units

Doors and horizontal profiles: embossed lacquered visone.

Cabinets above tall unit PR21

Doors: anodized moka frame and fumé reflecting glass.
Openings: tip-on.
Inner shelves: glass with black anodized frame.

Wall panelling

Panels: black elm.
Shelves: embossed lacquered carbone, thickness 1/8".

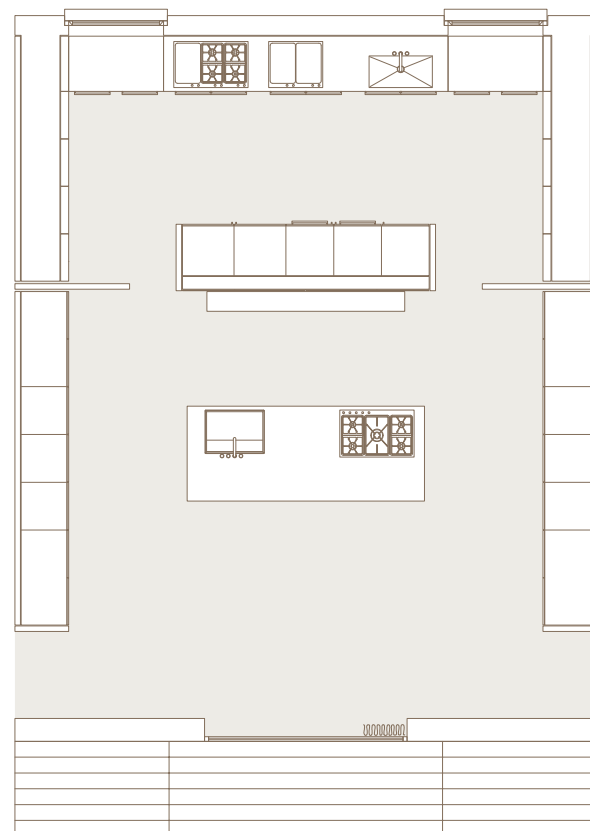
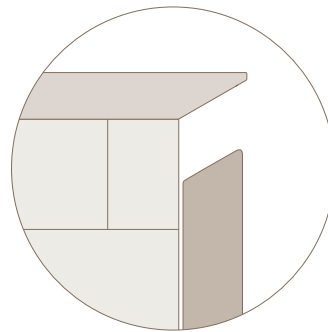

Basi Base units

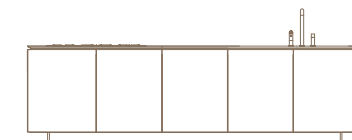
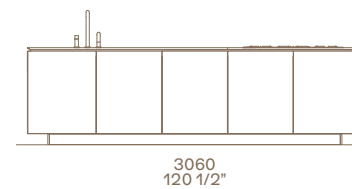
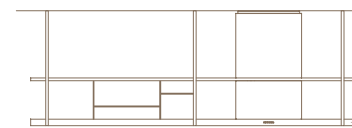

917
36"

3060
120 1/2"

Boiserie Wall panelling



3212
126 1/2"

2950
116 1/4"

Colonne Tall units

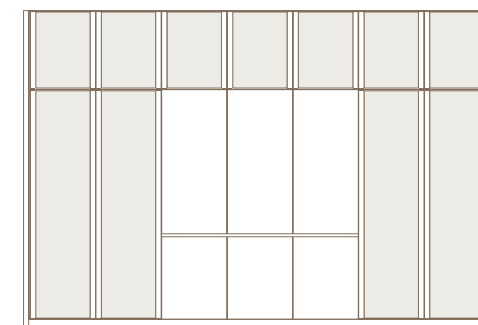

4200
165 1/4"

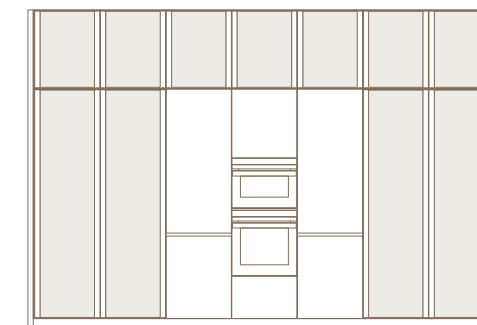

4200
165 1/4"

2950
116 1/4"

- 1 Piano cottura in acciaio scotch brite
5 fuochi personalizzato Poliform by Barazza, incasso filotop.
- 2 Lavello in acciaio scotch brite personalizzato Poliform by Barazza con sportello copripiletta, incasso filotop.
- 3 Attrezzatura in noce canaletto e alluminio anodizzato moka per cassetti interni ed estrattori.

- 4 Cappa Factory a isola in acciaio scotch brite.
- 5 Boiserie con pannelli in olmo nero.
- 6 Elementi sopra colonna vetrina PR21, ante apertura tip-on.
- 7 Colonne vetrina PR21 con ante ad apertura battente, ripiani interni e cassettiere.

- 8 Colonne centrali con forni e frigo/ congelatore, con ante ad apertura battente ed estrattori.
- 9 Attrezzatura in noce canaletto e alluminio anodizzato moka per cassettera interna.

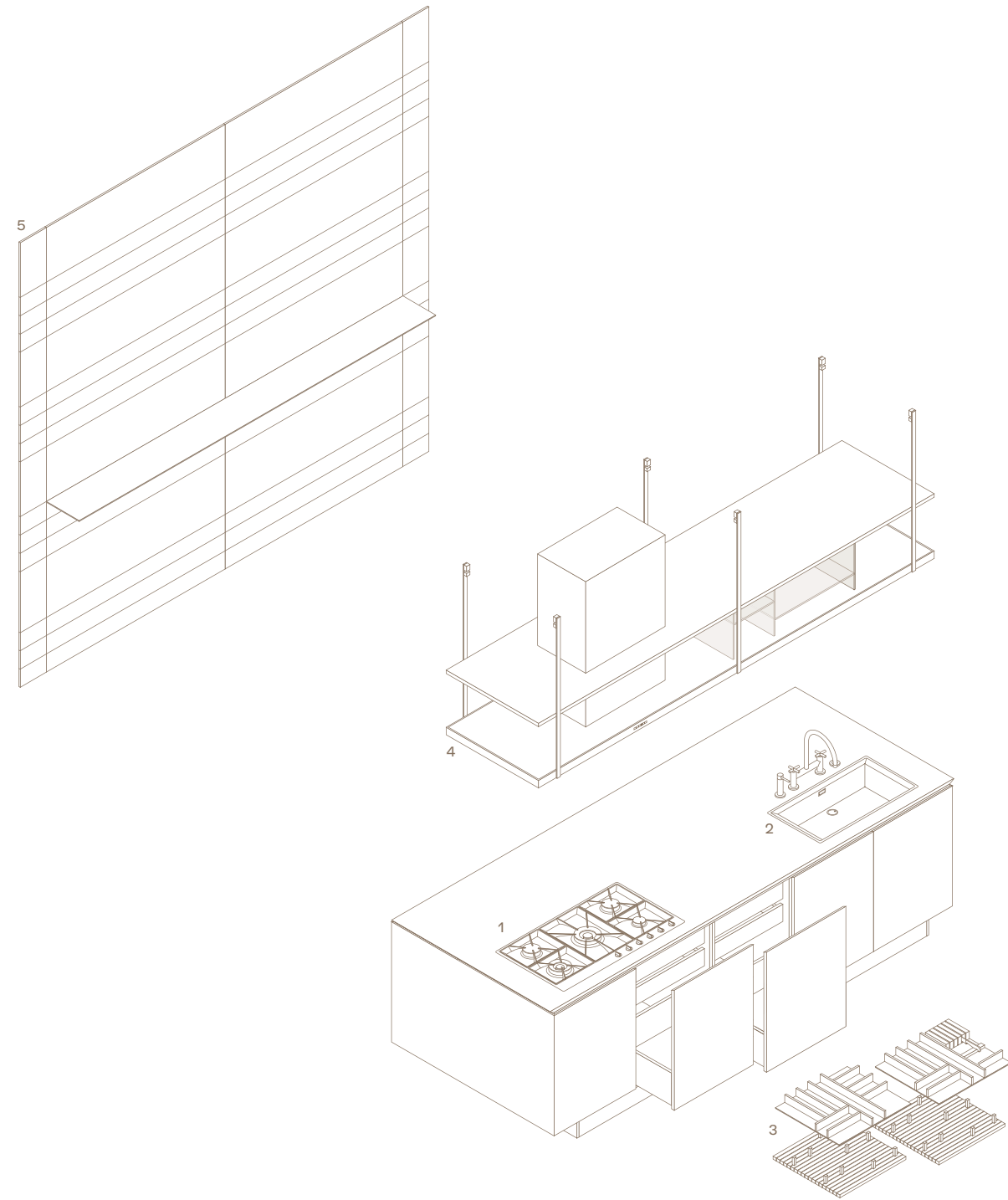

- 1 Personalized scotch brite steel hob with 5 burners Poliform by Barazza, flush built-in.
- 2 Personalized scotch brite steel sink Poliform by Barazza with drain cover, flush built-in.
- 3 Equipment in walnut canaletto and moka anodized aluminium for inner drawers and pull-out storage baskets.

- 4 Factory island-hood in scotch brite steel.
- 5 Wall panelling in black elm.
- 6 Elements above tall unit PR21, glass doors with tip-on opening.
- 7 Glass tall units PR21 with leaf doors, inner shelves and chest of drawers.

- 8 Central tall units with ovens, fridge and freezer with leaf doors and pull-out storage baskets.
- 9 Equipment in walnut canaletto and moka anodized aluminium for inner chest of drawers.

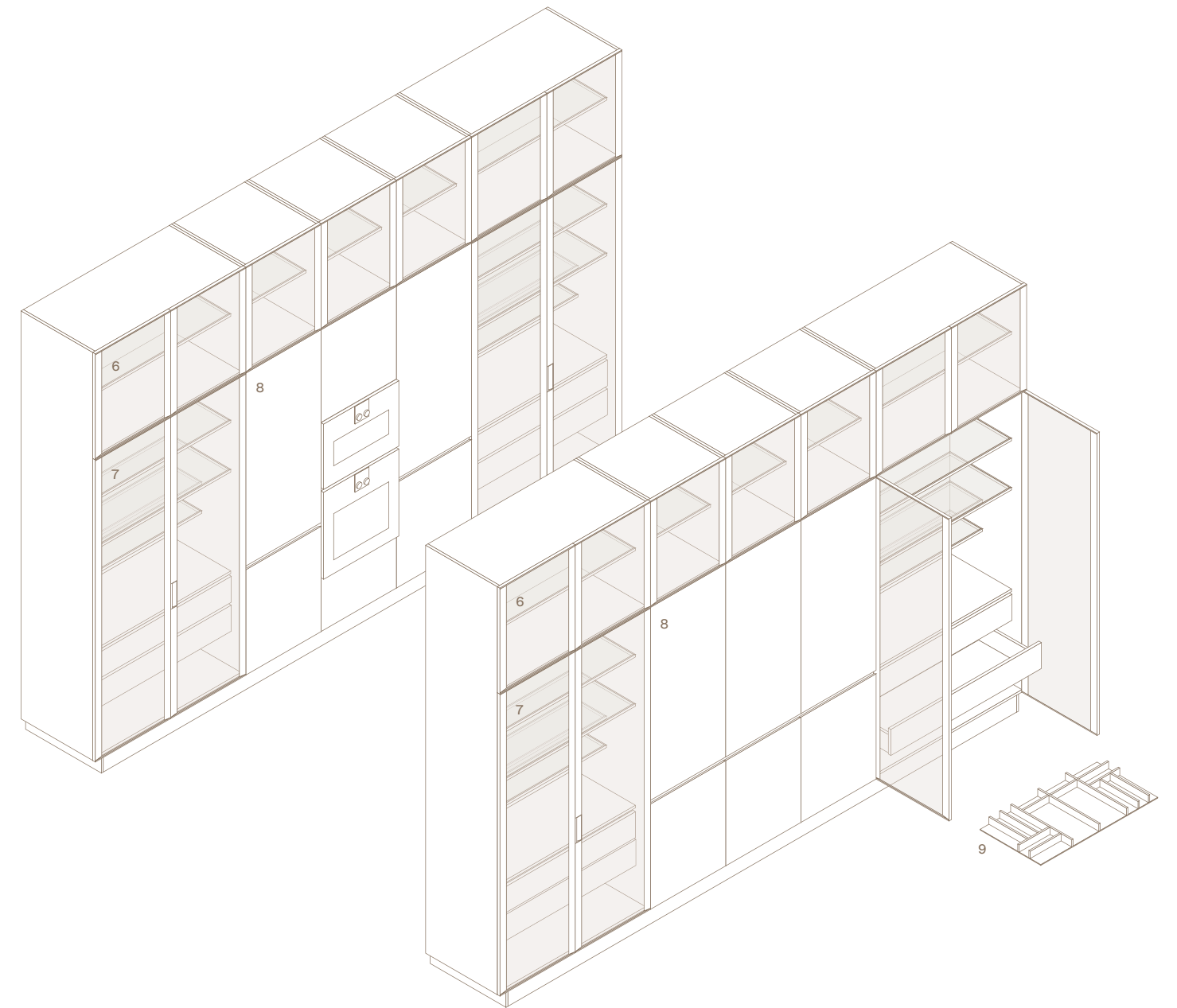

MY PLANET

Poliform reinterpreta la cucina con praticità e leggerezza. Merito di componenti come le maniglie, integrate o applicate, e di un'anta più leggera che consente la massima libertà nella scelta delle finiture. Particolari che determinano l'unicità di My Planet, un progetto in grado di dare vita a risultati compositivi originali ed esclusivi anche in ambienti dalle dimensioni contenute.

Poliform reinterprets the kitchen with practicality and lightness. This is thanks to components such as the handles, integrated or applied, and a lighter door that allows maximum freedom in the choice of finishes. Details that determine the uniqueness of My Planet, a project able to give life to original and exclusive compositional results even in environments of limited size.





Qui e nelle pagine precedenti: basi con ante ed estrattori in acciaio scotch brite, top in pietra fossena fiammata e acciaio scotch brite KitchenAid. Pensili con ante in olmo nero e colonne con ante in acciaio scotch brite. Shaker con struttura e ripiani in laccato opaco piombo, schienali e tubi in olmo nero.

This and previous pages: base units with doors and pull-out storage baskets in scotch brite steel, top in fossena stone blaze and scotch brite steel KitchenAid. Wall units with doors in black elm. Tall units with doors in scotch brite steel. Shaker with structure and shelves in mat lacquered piombo, back panels and hanging bars in black elm.





A sinistra: top in pietra fossena fiammata e acciaio scotch brite KitchenAid con piano cottura Domino a quattro fuochi e grill elettrico, friggitrice e piastra Teppan Yaki, lavello in acciaio scotch brite. Cappe a scomparsa in acciaio scotch brite personalizzate Poliform. Schienali in pietra fossena fiammata. Ante ed estrattori in acciaio scotch brite con maniglie Grip in acciaio godronato. Sotto: dettaglio di Shaker con struttura e ripiani in laccato opaco piombo, schienali e tubi in olmo nero.

To the left: top in fossena stone blaze and scotch brite steel KitchenAid, with Domino hob with four burners and electric grill, deep fryer and Teppan Yaki griddle, scotch brite steel sink. Poliform personalized retractable hood in scotch brite steel. Back panels in fossena stone blaze. Doors and pull-out storage baskets in scotch brite steel with Grip handles in knurled steel. Below: close-up of Shaker with structure and shelves in mat lacquered piombo, back panels and hanging bars in black elm.



A destra: dettaglio dell'estrattore con cassetto interno verniciato brown e attrezzatura in alluminio. Sotto: dettaglio del pensile con ante in olmo nero con apertura pieghevole e profilo luminoso.

To the right: close-up of pull-out storage basket with painted brown inner drawer frame and equipment in aluminium. Below: close-up of wall units, folding doors in black elm with lighted profile.





Qui e nelle pagine precedenti: basi con ante ed estrattori in laccato goffrato ghiaccio con maniglia integrata My Planet in laccato opaco piombo. Top in pietra fossena fiammata e acciaio scotch brite KitchenAid. Pensili con ante con apertura pieghevole e a ribalta in olmo nero. Shaker con struttura e ripiani in laccato opaco piombo, schienali e tubi in olmo nero. Sotto: dettaglio dell'anta in laccato goffrato ghiaccio con maniglia integrata My Planet in laccato opaco piombo.

This and previous pages: base units with doors and pull-out storage baskets in embossed lacquered ghiaccio with My Planet integrated handle in mat lacquered piombo. Top in fossena stone blaze and scotch brite steel KitchenAid. Wall units with folding and flap doors in black elm. Shaker with structure and shelves in mat lacquered piombo, back panels and hanging bars in black elm. Below: close-up of door in embossed lacquered ghiaccio with My Planet integrated handle in mat lacquered piombo.



MY PLANET

Design R&D Poliform

Basi p 740

Strutture: nobilitato grigio lavagna.
 Ante ed estrattori: acciaio scotch brite.
 Maniglie: Grip, acciaio godronato.
 Fianchi: acciaio scotch brite,
 spessore 6 mm.
 Top: pietra fossena fiammata
 spessore 52 mm;
 acciaio scotch brite KitchenAid,
 spessore 20 mm.
 Schienali: pietra fossena fiammata,
 spessore 20 mm.
 Zoccoli: laccato gofrato carbone.

Pensili p 410

Strutture: nobilitato grigio lavagna.
 Ante: olmo nero.
 Aperture: pieghevole con profilo
 luminoso, a ribalta con apertura tip-on.

Shaker p 120

Strutture e ripiani: laccato opaco
 piombo.
 Schienali e tubi: olmo nero.

Colonne p 640

Strutture: nobilitato grigio lavagna.
 Ante: acciaio scotch brite.
 Maniglie: Grip, acciaio godronato.
 Zoccoli: laccato gofrato carbone.

Base units d 29 1/4"

Structures: grey lavagna melamine.
 Doors and pull-out storage baskets:
 scotch brite steel.
 Handles: Grip, knurled steel.
 Side panels: scotch brite steel,
 thickness 1/4".
 Top: fossena stone blaze, thickness 2";
 scotch brite steel KitchenAid,
 thickness 3/4".
 Back panels: fossena stone blaze,
 thickness 3/4".
 Plinths: embossed lacquered carbone

Wall units d 16 1/4"

Structures: grey lavagna melamine.
 Doors: black elm.
 Openings: folding with lighted profile,
 flap with tip-on opening.

Shaker d 4 3/4"

Structures and shelves: mat lacquered
 piombo.
 Back panels and bars: black elm.

Tall units d 25 1/4"

Structures: grey lavagna melamine.
 Doors: scotch brite steel.
 Handles: Grip, knurled steel.
 Plinths: embossed lacquered carbone.

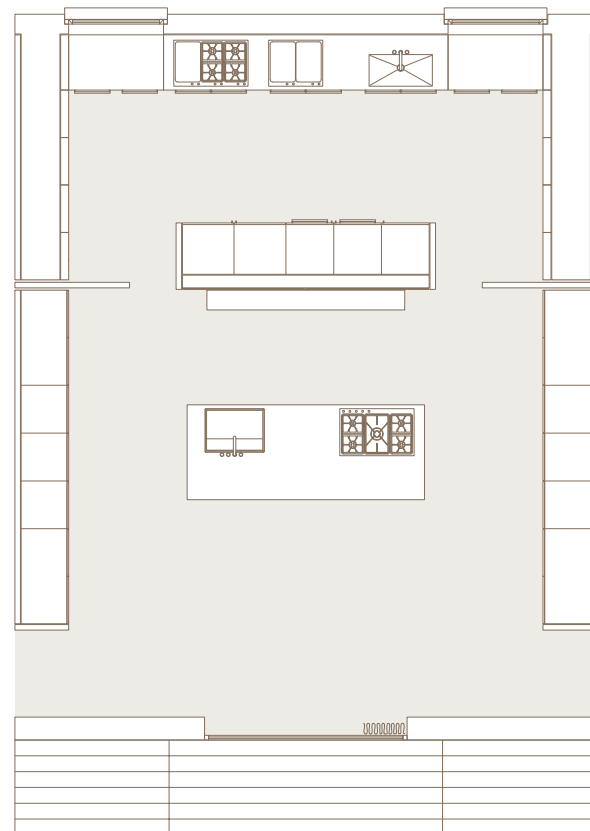
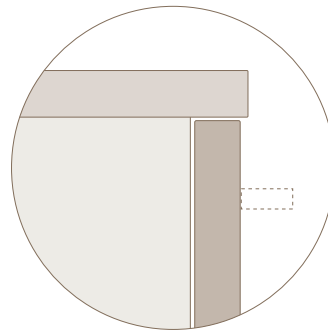
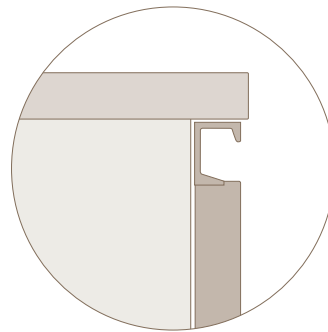

Basi e pensili Base units and wall units

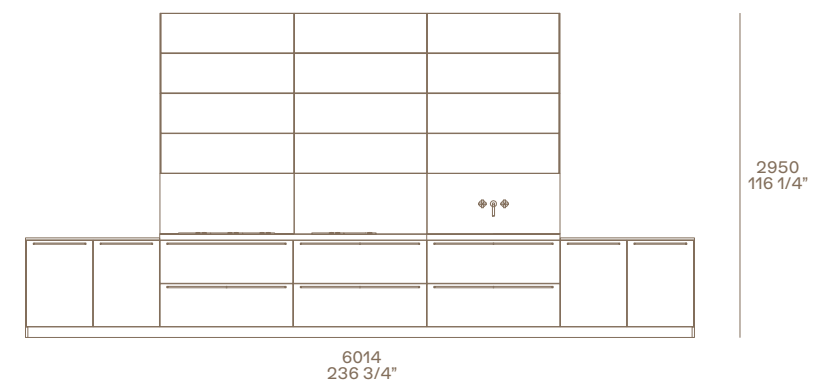

Shaker

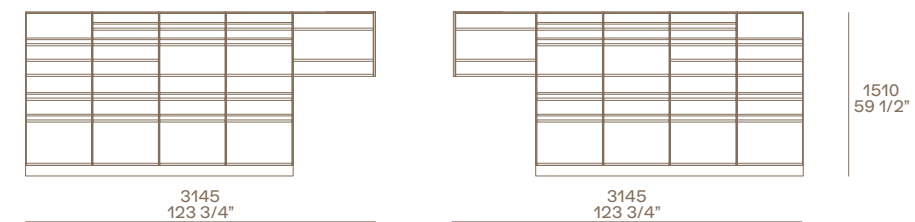

Colonne Tall units

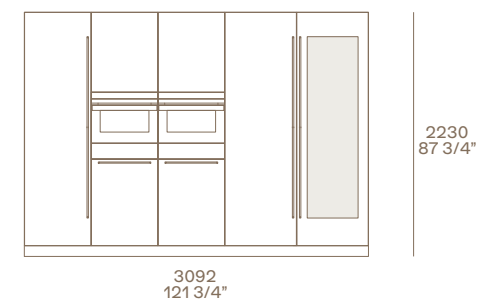

- 1 Piano cottura Domino con fuochi e grill elettrico, incasso tradizionale.
- 2 Friggitrice e piastra Teppan Yaki, incasso tradizionale.
- 3 Lavello in acciaio scotch brite, incasso sottotop.
- 4 Attrezzatura in alluminio per estrattori e cassette interni.

- 5 Pensili apertura pieghevole con profilo luminoso, a ribalta con apertura tip-on. Cappe a scomparsa in acciaio scotch brite personalizzate Poliform.
- 6 Colonne con forno, scaldavivande, frigo/ congelatore con ante ed estrattori.

- 7 Cantina vini con ripiani estraibili in vetro e alluminio.
- 8 Shaker laccato con tubi e schienali in olmo nero, contenitori in DuPont Corian® glacier white.

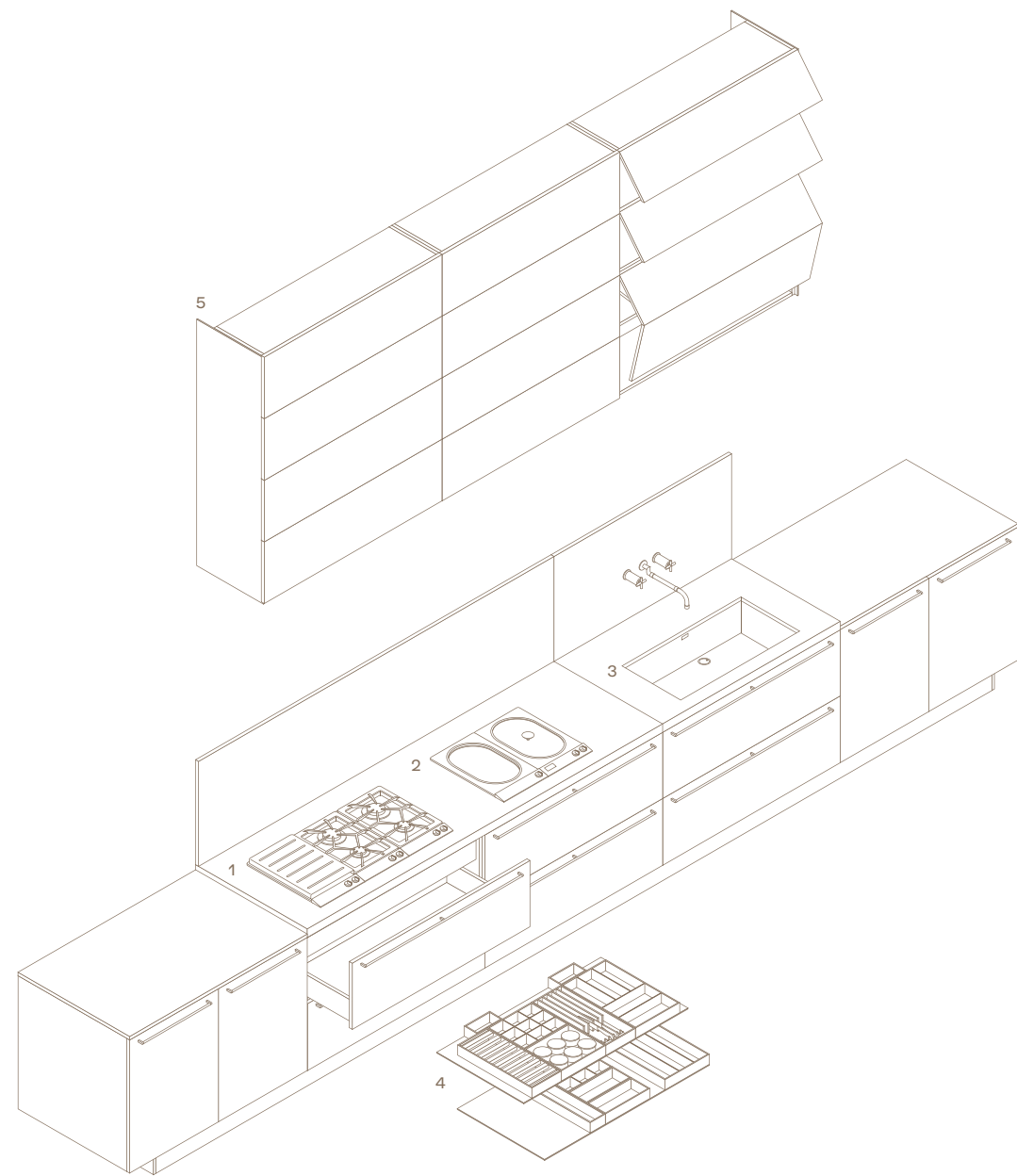

- 1 Domino hob with four burners and electric grill, classic built-in.
- 2 Deep fryer and Teppan Yaki griddle, classic built-in.
- 3 Scotch brite steel sink, under-top-mounted built-in.
- 4 Equipment in aluminium for pull-out storage baskets and inner drawers.

- 5 Wall units with folding doors with lighted profile, flap doors with tip-on opening. Poliform personalized pocket hoods in scotch brite steel.
- 6 Tall units with oven, plate warmer and fridge/freezer with doors and pull-out storage baskets.

- 7 Wine cooler with pull-out shelves in glass and aluminium.
- 8 Lacquered Shaker with black elm bars and back panels, spice holders in DuPont Corian® glacier white.

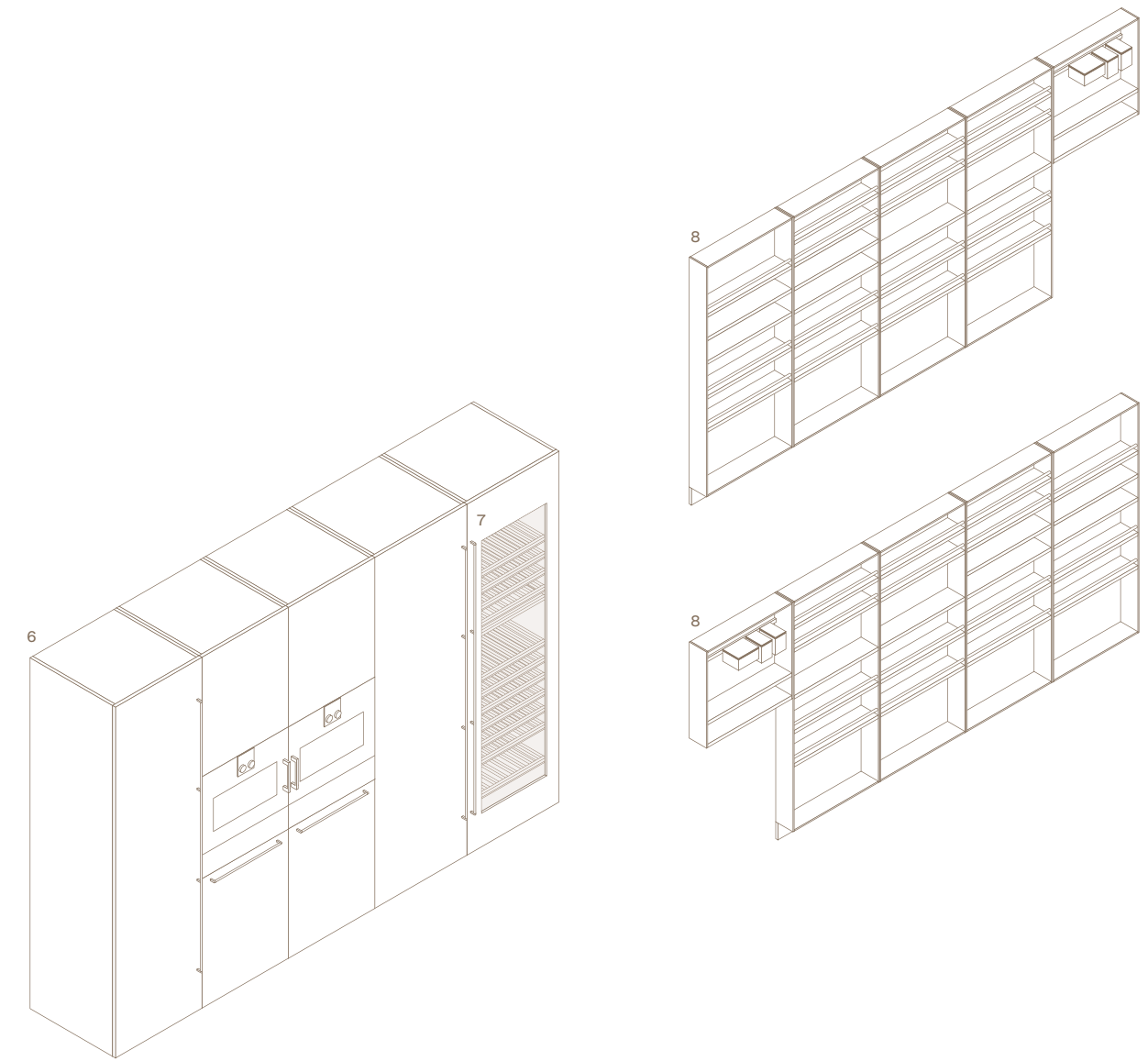



TWELVE

Twelve è l'esito di una ricerca estrema di essenzialità. Progettando l'anta più sottile della gamma, Carlo Colombo e Poliform disegnano una cucina dall'estetica rigorosa, equilibrata tra minimi spessori e massima ampiezza delle superfici. La grande varietà di finiture e materiali disponibili – dal vetro all'acciaio – apre a ogni possibile interpretazione stilistica.

Twelve is the result of an extreme search for minimalism. By creating the thinnest door of the range, Carlo Colombo and Poliform design a kitchen with a rigorous look, balanced between minimum thickness and maximum width of the surfaces. The wide variety of finishes and materials available – from glass to steel – opens up any possible stylistic interpretation.





Nelle pagine precedenti: basi con ante, cassetti ed estrattori in vetro satinato bianco extrachiari con sagoma in laccato goffrato carbone, fianchi e top in dektion bianco. Cappa Work a isola in acciaio scotch brite e vetro. Colonne con ante in laccato metallico bronzo. In appoggio sulle basi, piano snack Sydney in massello tinto olmo nero. Sgabelli Harmony con seduta in rovere spessart e struttura in cromo nero. A destra: piano cottura filotop a cinque fuochi e lavello sottotop in acciaio scotch brite personalizzati Poliform by Barazza. Sotto: dettaglio del profilo di apertura in laccato goffrato carbone.

Previous pages: base units with doors, drawers and pull-out storage baskets in extralight bianco frosted glass with embossed lacquered carbone profile, sides and top in dektion bianco. Work island-hood in scotch brite steel and glass. Tall units with doors in metal lacquer bronzo. On the base units is the Sydney snack top in solid wood stained black elm. Harmony stools with seats in spessart oak and black chrome structure. To the right: five-burner flush-mount hob and personalized stainless scotch brite steel undermount sink Poliform by Barazza. Below: a detail of the opening profile in embossed lacquered carbone.



Basi con ante, cassetti ed estrattori in vetro satinato bianco extrachiaro, fianchi e top in dektion bianco. In appoggio sulle basi, piano snack Sydney in massello tinto olmo nero. Sgabello Harmony con seduta in rovere spessart e struttura in cromo nero.

Base units with doors, drawers and pull-out storage baskets in bianco extralight frosted glass, sides and top in dektion bianco. On the base units is the Sydney snack top in solid wood stained black elm. Harmony stool with seat in spessart oak and black chrome structure.





A sinistra: basi con ante, cassetti ed estrattori in vetro satinato bianco extrachiaro con sagoma in laccato goffrato carbone, fianchi e top in dektion bianco. Cappa Work a isola in acciaio scotch brite e vetro. Colonne con ante in laccato metallico bronzo e colonne con ante vetrina PR22 in vetro fumé, profilo anodizzato nero e maniglia integrata verniciata nero. Sotto: dettaglio dell'estrattore per colonna con cassetti interni in noce canaletto e attrezzatura in noce canaletto e alluminio anodizzato moka.

To the left: base units with doors, drawers and pull-out storage baskets in bianco extralight frosted glass with embossed lacquered carbone profile, sides and top in dektion bianco. Work island-hood in scotch brite steel and glass. Tall units with doors in metal lacquer bronzo and tall units PR22 with fumé glass doors, black anodized profile and integrated handle painted black. Below: a detail of the tall unit pull-out basket with internal drawers in walnut canaletto and equipment in walnut canaletto and anodized aluminium moka.







Nelle pagine precedenti: basi con ante, cassetti ed estrattori in vetro satinato bianco extrachiaro con sagoma in laccato goffrato carbone, fianchi e top in dehton bianco. Cappa Work a isola in acciaio scotch brite e vetro. Colonne con ante in laccato metallico bronzo e colonne con ante vetrina PR22 in vetro fumé. In appoggio sulle basi, piano snack Sydney in massello tinto olmo nero. Sgabelli Harmony con seduta in rovere spessart e struttura in cromo nero. A sinistra: colonne con ante vetrina PR22 in vetro fumé, profilo anodizzato nero e maniglia integrata verniciata nero. Sotto: dettaglio dell'anta vetrina PR22 con maniglia integrata, cassettiere in laminato touch nero, ripiani in vetro con telaio in alluminio anodizzato nero e illuminazione a led integrata.

Previous pages: base units with bianco extralight frosted glass doors, drawers and pull-out storage baskets with embossed lacquered carbone profile, sides and top in dehton bianco. Work island-hood in scotch brite steel and glass. Tall units with doors in metal lacquer bronzo and tall units PR22 with fumé glass doors. On the base units is the Sydney snack top in solid wood stained black elm. Harmony stools with seats in spessart oak and black chrome structure. To the left: tall units PR22 with fumé glass doors, black anodized profile and integrated black painted handle. Below: a detail of the glass door PR22 with integrated handle, chests of drawers in laminate touch nero, glass shelves with black anodized aluminium frame and integrated led lighting.



A destra: colonne con ante vetrina PR22 in vetro fumé, profilo anodizzato nero e maniglia integrata verniciato nero. All'interno, ripiani in vetro con telaio in alluminio anodizzato nero e illuminazione a led integrata.

To the right: tall units PR22 with fumé glass doors, black anodized profile and integrated black painted handle. Inside, glass shelves with black anodized aluminium frame and integrated led lighting.



TWELVE

Design Carlo Colombo and R&D Poliform

Basi p 1280

Strutture: nobilitato grigio lavagna.
 Ante, cassetti ed estrattori: vetro satinato 2301 bianco extrachiaro, profilo anodizzato nero.
 Profilo di apertura: sagoma laccato goffrato carbone.
 Fianchi: dektion bianco, spessore 12 mm.
 Top: dektion bianco con telaio di supporto laccato goffrato carbone.
 Zoccoli: laccato goffrato carbone.

Snack

Sydney: massello tinto olmo nero.

Colonne p 640

Strutture: nobilitato grigio lavagna.
 Ante: laccato metallico bronzo.
 Fianchi: laccato metallico bronzo, spessore 20 mm.
 Distanziatori verticali: laccato metallico bronzo.
 Zoccoli: laccato goffrato carbone.

Colonne vetrina PR22 p 640

Strutture: nobilitato grigio lavagna.
 Ante: vetro 5059 fumé, profilo anodizzato nero.
 Maniglia: integrata verniciato nero.
 Fianchi: laccato goffrato carbone, spessore 12 mm.
 Zoccoli: laccato goffrato carbone.

Complementi

Sgabello Harmony: rovere spessart, struttura cromo nero.

Base units d 50 1/2"

Structures: grey lavagna melamine.
 Doors, drawers and pull-out storage baskets: etched glass 2301 bianco extralight, black anodized profile.
 Opening profile: embossed lacquered carbone.
 Side panels: dektion bianco, thickness 1/2".
 Top: dektion bianco with support frame in embossed lacquered carbone.
 Plinths: embossed lacquered carbone.

Snack

Sydney: solid wood dyed black elm.

Tall units d 25 1/4"

Structures: grey lavagna melamine.
 Doors: metal lacquered bronzo.
 Sides: metal lacquered bronzo, thickness 3/4".
 Vertical spacers: metal lacquered bronzo.
 Plinths: embossed lacquered carbone.

Glass tall units PR22 d 25 1/4"

Structures: grey lavagna melamine.
 Doors: glass 5059 fumé, profile black anodized.
 Handle: integrated painted black.
 Side panels: embossed lacquered carbone thickness 1/2".
 Plinths: embossed lacquered carbone.

Accessories

Harmony stool: spessart oak, structure black chrome.

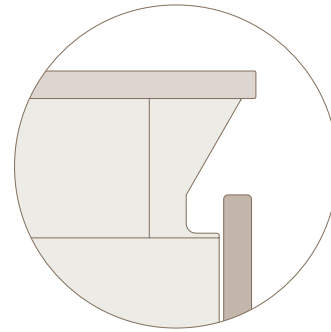

Basi Base units

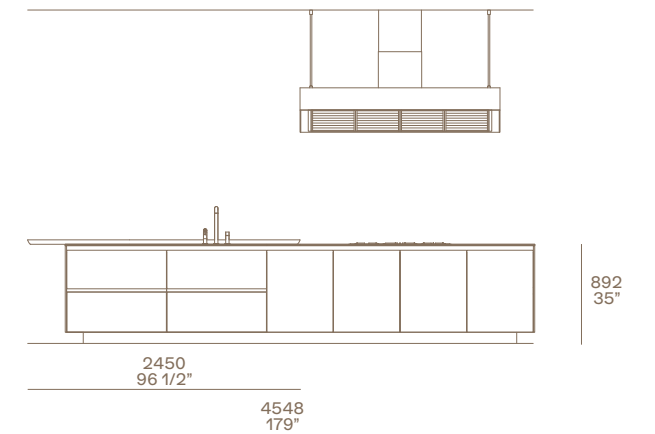
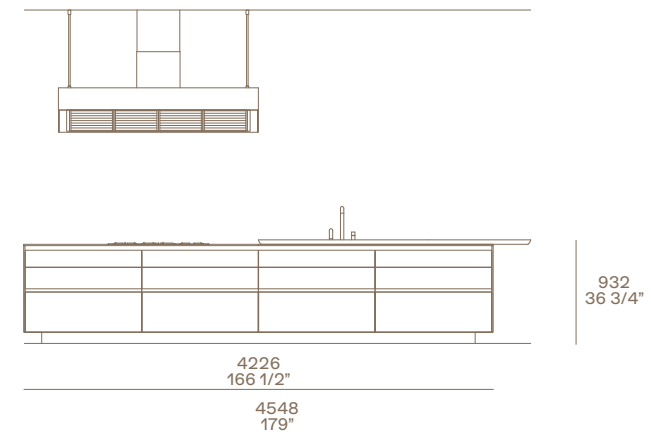

Colonne Tall units

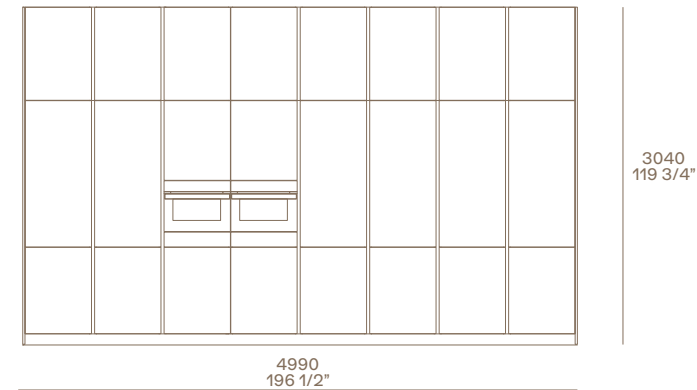

Colonne vetrina Glass tall units

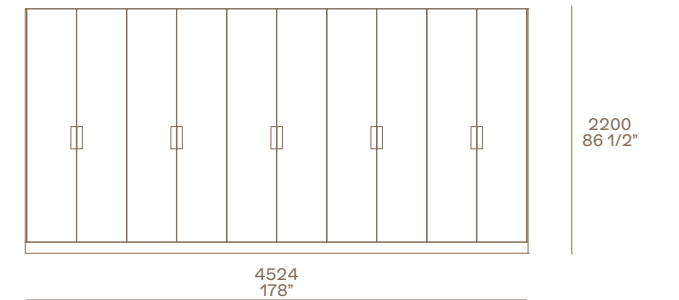

Harmony Design Rodrigo Torres

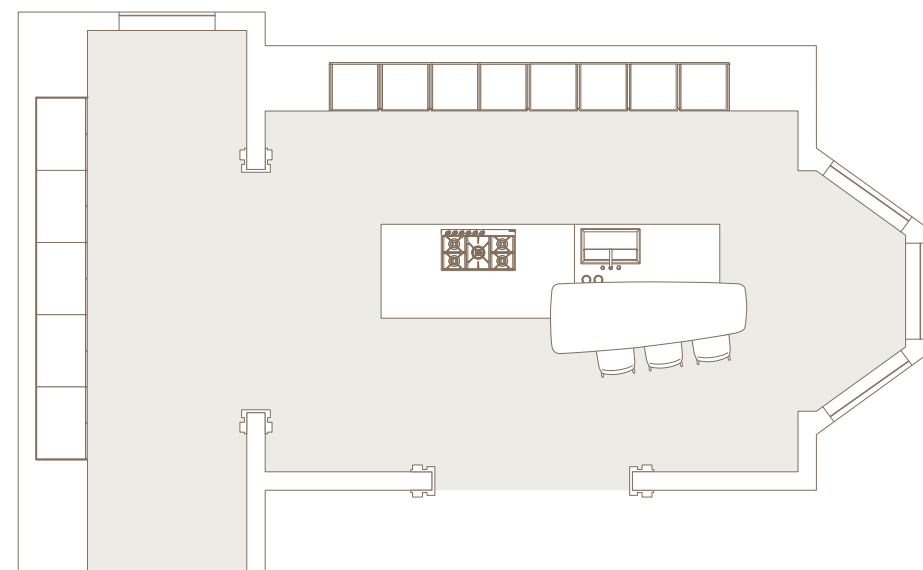
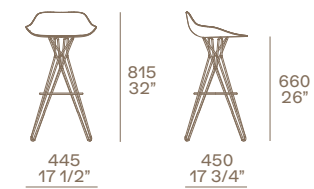

- 1 Colonne con forni e frigoriferi con ante ad apertura battente ed estrattori, cassetti interni in noce canaletto e attrezzatura in noce canaletto e alluminio anodizzato moka.
- 2 Piano cottura filotop 5 fuochi in acciaio scotch brite personalizzato Poliform by Barazza.

- 3 Lavello sottotop in acciaio scotch brite personalizzato Poliform by Barazza.
- 4 Piano snack Sydney 2450 x 895.
- 5 Attrezzatura in noce canaletto e alluminio anodizzato moka per cassetti ed estrattori.

- 6 Cappa Work a isola in acciaio scotch brite e vetro, personalizzata Poliform.
- 7 Colonne vetrina PR22 con ante ad apertura battente, cassettiere in laminato touch nero e ripiani in vetro con telaio in alluminio anodizzato nero.

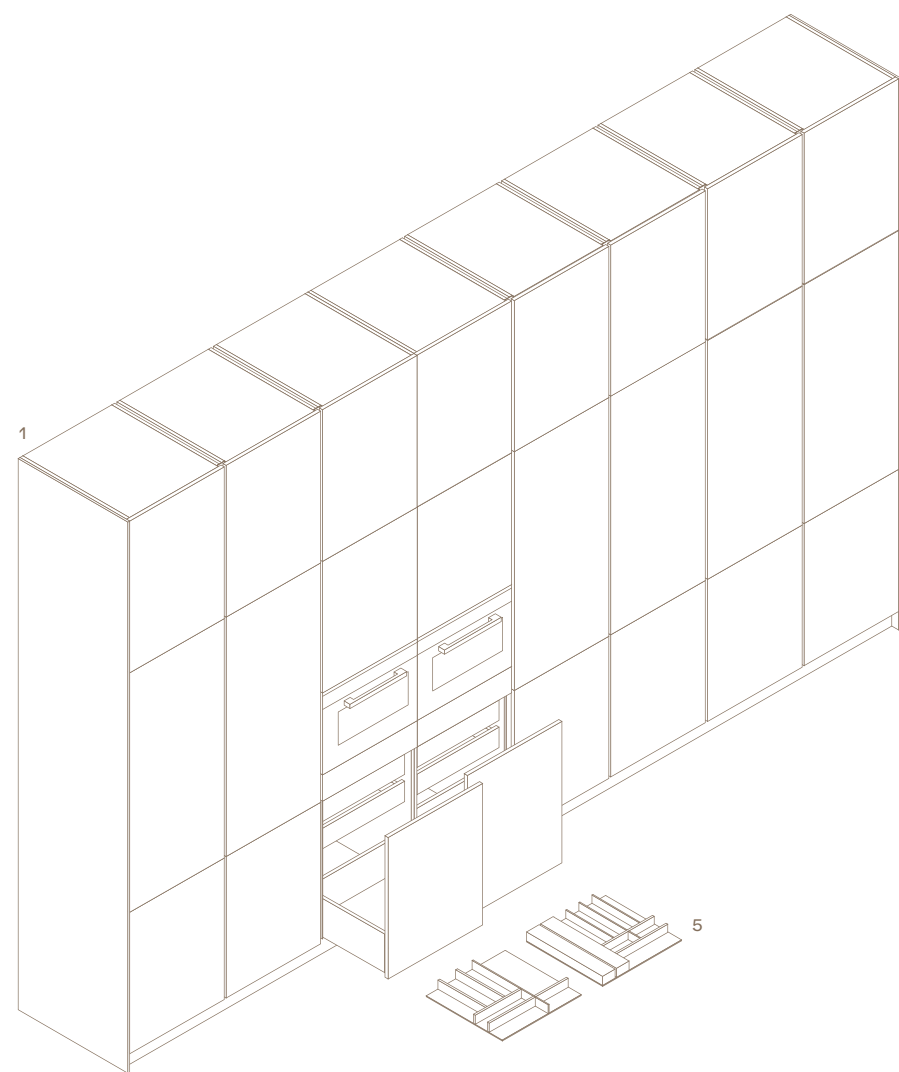

- 1 Tall units with ovens and refrigerators, pull-out storage baskets for tall unit with internal drawers in walnut canaletto and equipment in walnut canaletto and anodized aluminium moka, leaf doors.
- 2 Flush-mount hob 5 burners in scotch brite steel personalized Poliform by Barazza.

- 3 Undermount sink in scotch brite steel personalized Poliform by Barazza.
- 4 Snack top Sydney 96 1/2" x 31 1/4".
- 5 Equipment in walnut canaletto and anodized aluminium moka for drawers and pull-out storage baskets.

- 6 Island-hood Work in scotch brite steel and glass, personalized Poliform.
- 7 Glass tall units PR22, leaf doors, equipped with chests of drawers in laminate touch nero and glass shelves with black anodized aluminium frame.

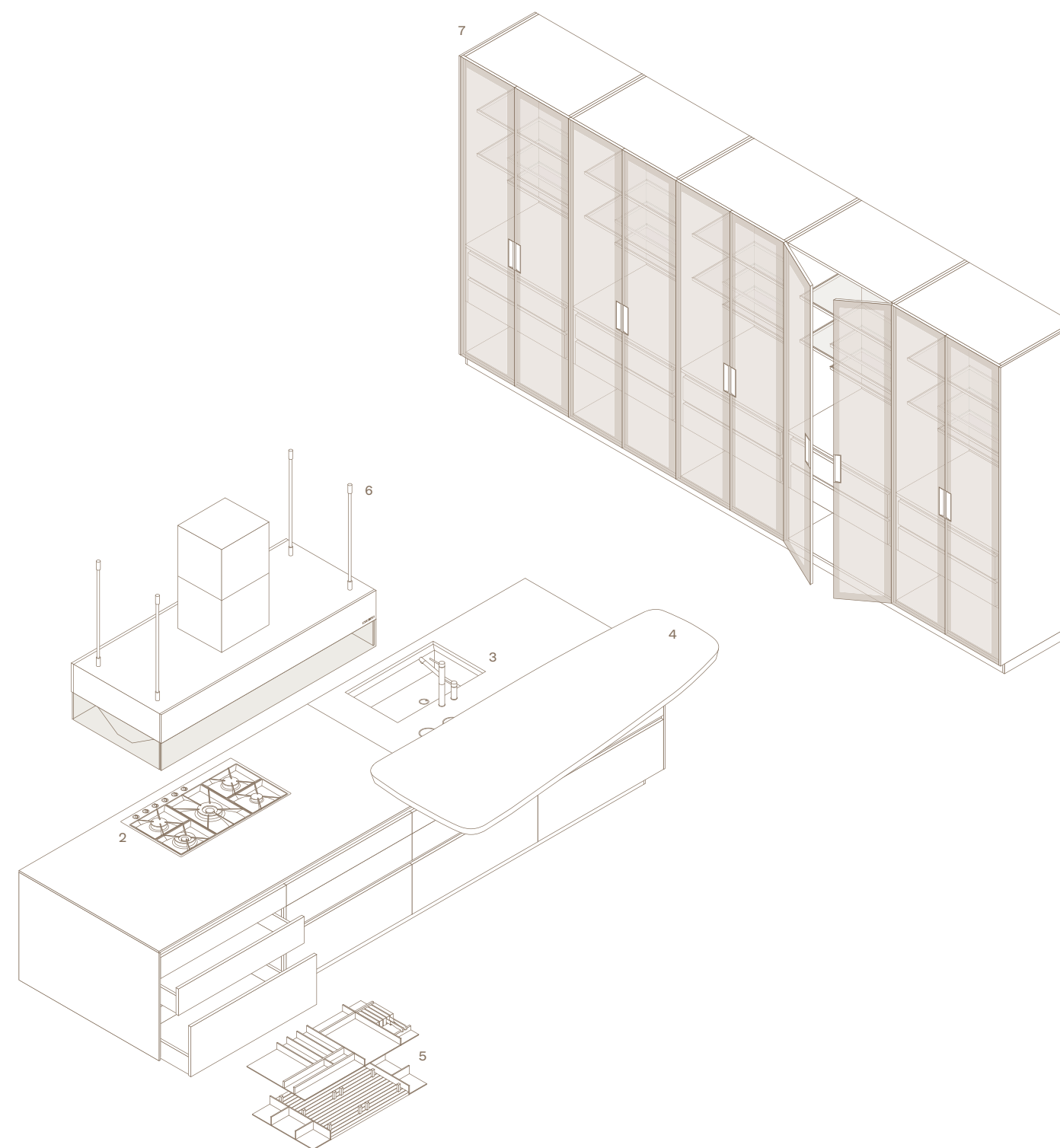

A destra: basi con ante, cassetti ed estrattori in acciaio scotch brite, top in acciaio scotch brite Barazza con telaio di supporto in alluminio laccato goffrato carbone. Shaker con schienali in noce c., ripiani in alluminio anodizzato moka e tubi in laccato goffrato moka.

To the right: base units with doors, drawers and pull-out storage baskets in scotch brite steel, top in scotch brite steel Barazza with carbone embossed lacquered aluminium support frame. Shaker with back panels in walnut c., shelves in moka anodized aluminium and bars in embossed lacquered moka.







Qui e nelle pagine precedenti: basi con ante, cassetti ed estrattori in acciaio scotch brite, top in acciaio scotch brite Barazza con telaio di supporto in alluminio laccato goffrato carbone. Colonne con ante in vetro satinato nero e telaio anodizzato nero. Piano snack Blade in massello noce canaletto. Sgabelli Harmony in rovere spessart e cromo nero.

This and previous pages: base units with doors, drawers and pull-out storage baskets in scotch brite steel, top in scotch brite steel Barazza with carbone embossed lacquered aluminium support frame. Tall units with doors in black frosted glass and black anodized frame. Blade snack table in solid wood walnut canaletto. Harmony stools in spessart oak and black chrome.





A sinistra: basi con ante, cassetti ed estrattori in acciaio scotch brite, top in acciaio scotch brite Barazza con telaio di supporto in alluminio laccato gofrato carbone. Colonne con ante in vetro satinato nero e telaio anodizzato nero. Shaker con schienali in noce c., ripiani in alluminio anodizzato moka e tubi in laccato gofrato moka.

To the left: base units with doors, drawers and pull-out storage baskets in scotch brite steel, top in scotch brite steel Barazza with carbone embossed lacquered aluminium support frame. Tall units with doors in black frosted glass and black anodized frame. Shaker with back panels in walnut c., shelves in moka anodized aluminium and bars in embossed lacquered moka.



A sinistra: dettaglio del cassetto interno verniciato brown con sistema di illuminazione interna a led. Attrezzatura in noce canaletto e alluminio anodizzato moka con portaposate, portacoltelli e portaspezie in ceramica. Sotto: dettaglio del caratteristico top con profilo d'apertura in alluminio laccato goffrato carbone. Ante in acciaio scotch brite e piano in acciaio scotch brite Barazza con telaio di supporto alluminio laccato goffrato carbone.

To the left: close-up of inner drawer painted brown with inner led lighting system. Equipment in walnut canaletto and moka anodized aluminium with pot rack, knife rack and spice rack in ceramic. Below: close-up of the characterizing top with carbone embossed lacquered aluminium handle profile. Doors in scotch brite steel and top in scotch brite steel Barazza with carbone embossed lacquered aluminium support frame.







Nelle pagine precedenti: basi con ante, cassetti ed estrattori in acciaio scotch brite, top in acciaio scotch brite Barazza con telaio di supporto in alluminio laccato goffrato carbone. Colonne con ante in vetro satinato nero e telaio anodizzato nero. Shaker con schienali in noce c., ripiani in alluminio anodizzato moka e tubi in laccato goffrato moka. Piano snack Blade in massello noce canaletto. Sgabelli Harmony in rovere spessart e cromo nero. A sinistra: estrattore per colonna con anta in vetro satinato nero e telaio di alluminio anodizzato nero con sistema di illuminazione interna a led. Piattaia, cassetti interni e attrezzatura in noce canaletto e alluminio anodizzato moka. Sotto: contenitore porta-spezie in ceramica con coperchio in noce canaletto.

Previous pages: base units with doors, drawers and pull-out storage baskets in scotch brite steel, top in scotch brite steel Barazza with carbone embossed lacquered aluminium support frame. Tall units with doors in black frosted glass and black anodized frame. Shaker with back panels in walnut c., shelves in moka anodized aluminium and bars in embossed lacquered moka. Blade snack table in solid wood walnut canaletto. Harmony stools in spessart oak and black chrome. To the left: pull-out storage basket for tall unit with black frosted glass door and black anodized aluminium frame with led lighting system. Plate rack, inner drawers and equipment in walnut canaletto and moka anodized aluminium. Below: ceramic spice container with walnut canaletto lid.

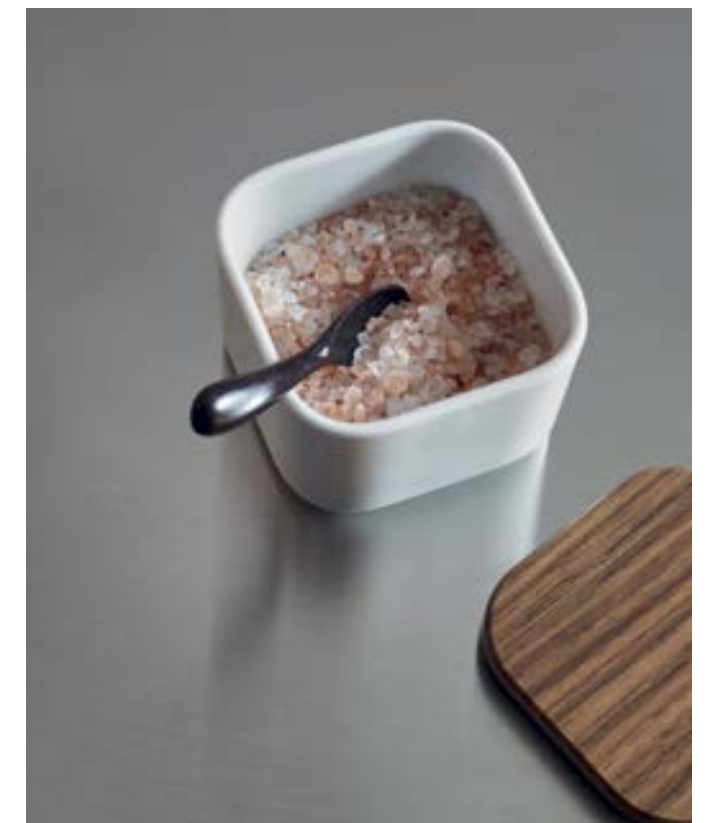

A destra: top in acciaio scotch brite Barazza con telaio di supporto in alluminio laccato goffrato carbone. Piano cottura a cinque fuochi in acciaio scotch brite saldato personalizzato Poliform by Barazza. Cappa Downdraft a scomparsa in acciaio scotch brite e vetro nero. Cassetti ed estrattori in acciaio scotch brite, interno in verniciato brown con piattina in noce canaletto.

To the right: top in scotch brite steel Barazza with carbone embossed lacquered aluminium support frame. Personalized soldered scotch brite steel hob with five burners Poliform by Barazza. Downdraft retractable hood in scotch brite steel and black glass. Drawers and pull-out storage baskets in scotch brite steel, interior painted brown with walnut canaletto plate holder.



TWELVE

Design Carlo Colombo and R&D Poliform

Basi p 1280

Strutture: nobilitato grigio lavagna.
Ante, cassetti ed estrattori: acciaio scotch brite.
Fianchi: acciaio scotch brite, spessore 12 mm.
Top: acciaio scotch brite Barazza con telaio di supporto laccato goffrato carbone.
Zoccoli: laccato goffrato carbone.

Snack

Blade: massello noce canaletto.

Colonne p 640

Strutture: nobilitato grigio lavagna.
Ante: vetro satinato nero 1303 con telaio in alluminio anodizzato nero.
Fianchi: vetro satinato nero, spessore 12 mm.
Distanziatori verticali: laccato carbone.

Shaker p 120

Strutture: alluminio anodizzato moka.
Schienali: noce c.
Ripiani e tubi: laccato goffrato moka.

Complementi

Sgabello Harmony: rovere spessart e cromo nero.

Base units d 50 1/2"

Structures: grey lavagna melamine.
Doors, drawers and pull-out storage baskets: scotch brite steel.
Side panels: scotch brite steel, thickness 1/2".
Top: scotch brite steel Barazza with support frame in embossed lacquered carbone.
Plinths: embossed lacquered carbone.

Snack

Blade: solid wood walnut canaletto.

Tall units d 25 1/4"

Structures: grey lavagna melamine.
Doors: black 1303 frosted glass with black anodized aluminium frame.
Side panels: black frosted glass, thickness 1/2".
Vertical spacers: lacquered carbone.

Shaker d 4 3/4"

Structures: moka anodized aluminium.
Back panels: walnut c.
Shelves and bars: embossed lacquered moka.

Accessories

Harmony stool: spessart oak and black chrome.

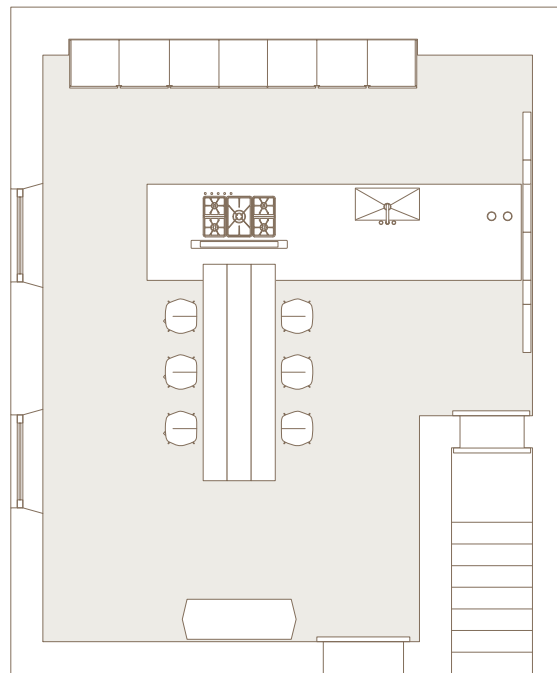
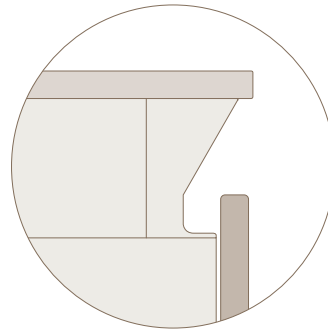

Basi Base units

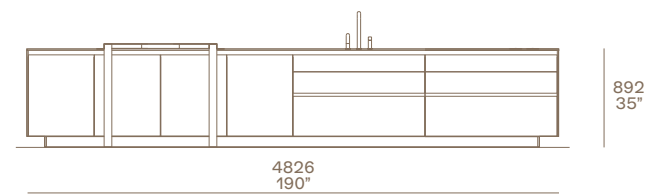
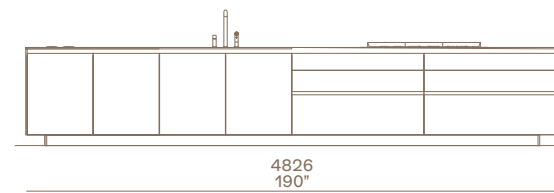

Shaker Shaker

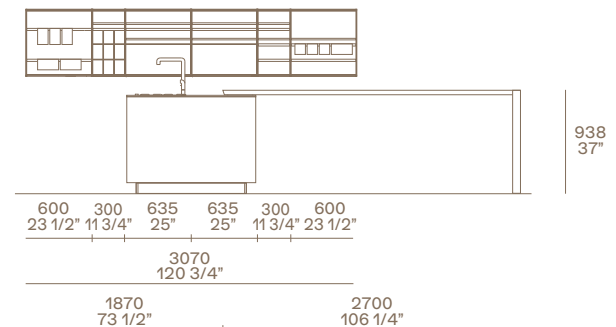

Colonne Tall units

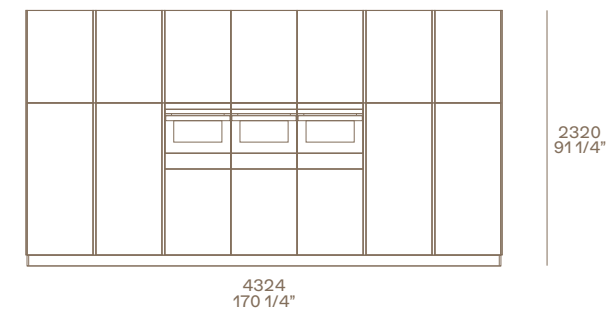

Harmony Design Rodrigo Torres



- 1 Piano cottura 5 fuochi in acciaio scotch brite saldato personalizzato Poliform by Barazza.
- 2 Lavello in acciaio scotch brite saldato.
- 3 Cappa Downdraft in acciaio scotch brite e vetro nero, filotop.

- 4 Attrezzatura in noce canaletto per estrattori.
- 5 Attrezzatura in noce canaletto e alluminio anodizzato moka per cassetti.
- 6 Piano snack Blade 2700 x 1022.
- 7 Shaker con ripiani, vani a giorno, portabicchieri e contenitori.

- 8 Colonne con forno e scaldavivande con ante ad apertura battente ed estrattori.
- 9 Attrezzatura in noce canaletto e alluminio anodizzato moka per cassetti interni ed estrattori.

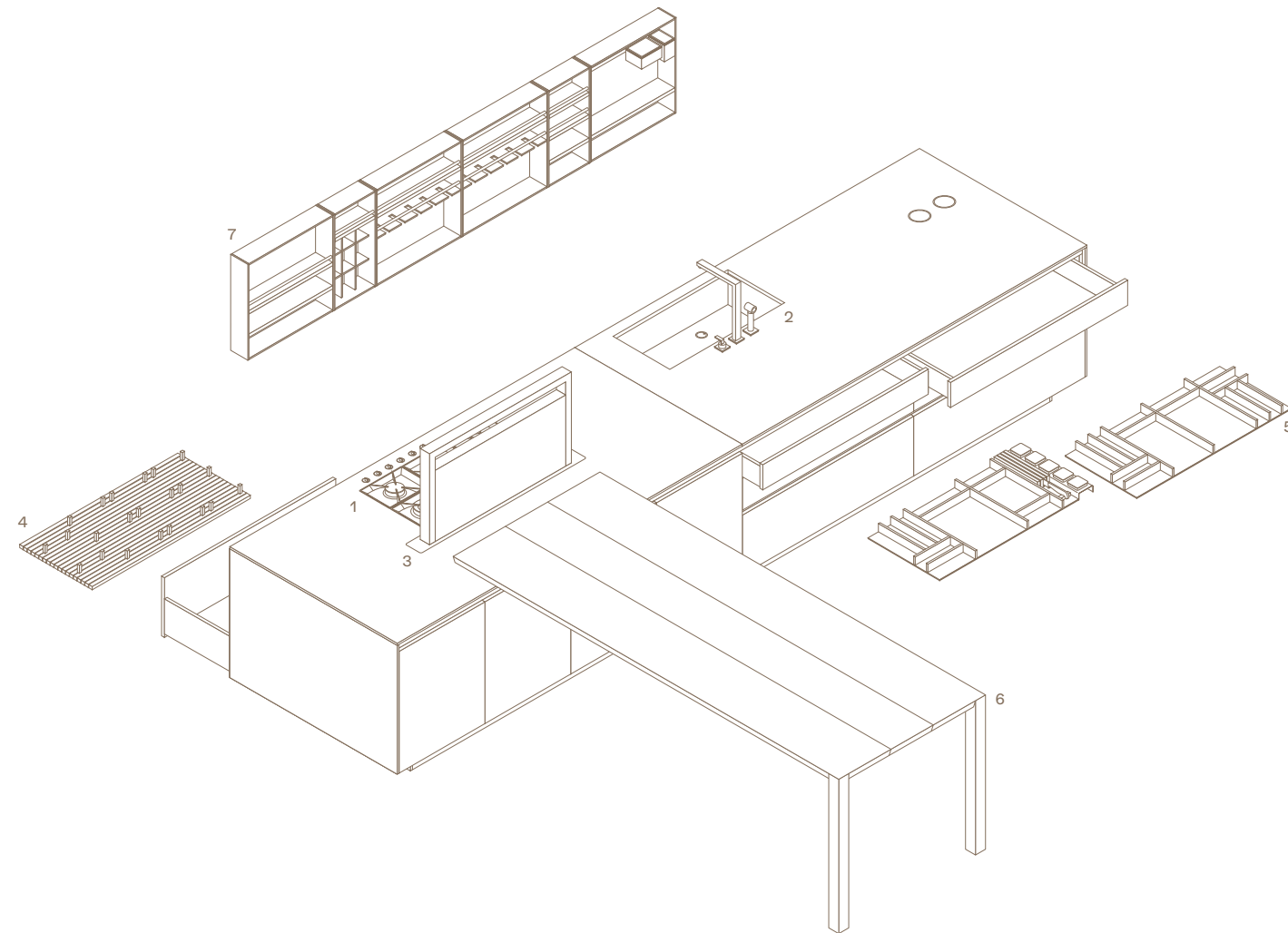

- 1 Personalized soldered hob in scotch brite steel with 5 burners Poliform by Barazza.
- 2 Soldered sink in scotch brite steel.
- 3 Downdraft hood in scotch brite steel and black glass, flush built-in.

- 4 Equipment in walnut canaletto for pull-out storage baskets.
- 5 Equipment in walnut canaletto and moka anodized aluminium for drawers.
- 6 Blade snack table 106 1/4" x 40 1/4".
- 7 Shaker with shelves, open compartments, glass racks and containers.

- 8 Tall units with oven and plate warmer, with leaf doors and pull-out storage baskets.
- 9 Equipment in walnut canaletto and moka anodized aluminium for inner drawers and pull-out storage baskets.

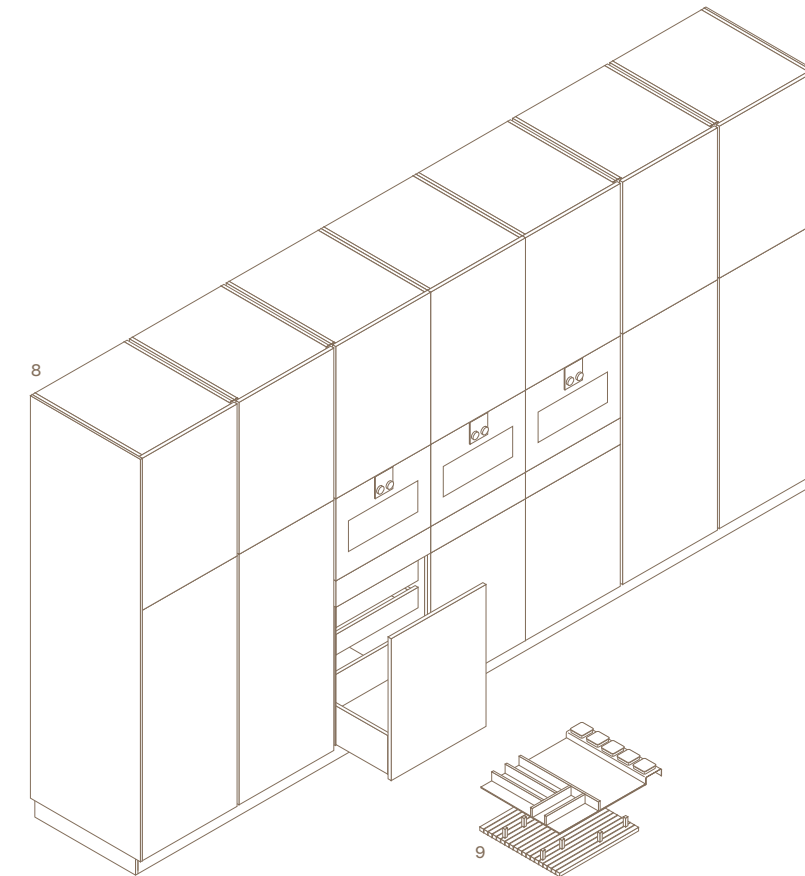



ALEA

Spessore ridotto, apertura a gola e massima versatilità nella scelta delle finiture: sono le caratteristiche che rendono l'anta Alea unica per possibilità compositive e personalizzazione. Un design lineare fatto di superfici piane e volumi geometrici, capace di ridefinire l'ambiente cucina unendo all'altissima capacità operativa un'estetica minimale.

Reduced thickness, groove opening, and maximum versatility in the choice of finishes: these are the characteristics that make the Alea door unique for compositional possibilities and customisation. A linear design made of flat surfaces and geometric volumes, capable of redefining the kitchen environment by combining a very high operational capability with a minimalistic style.

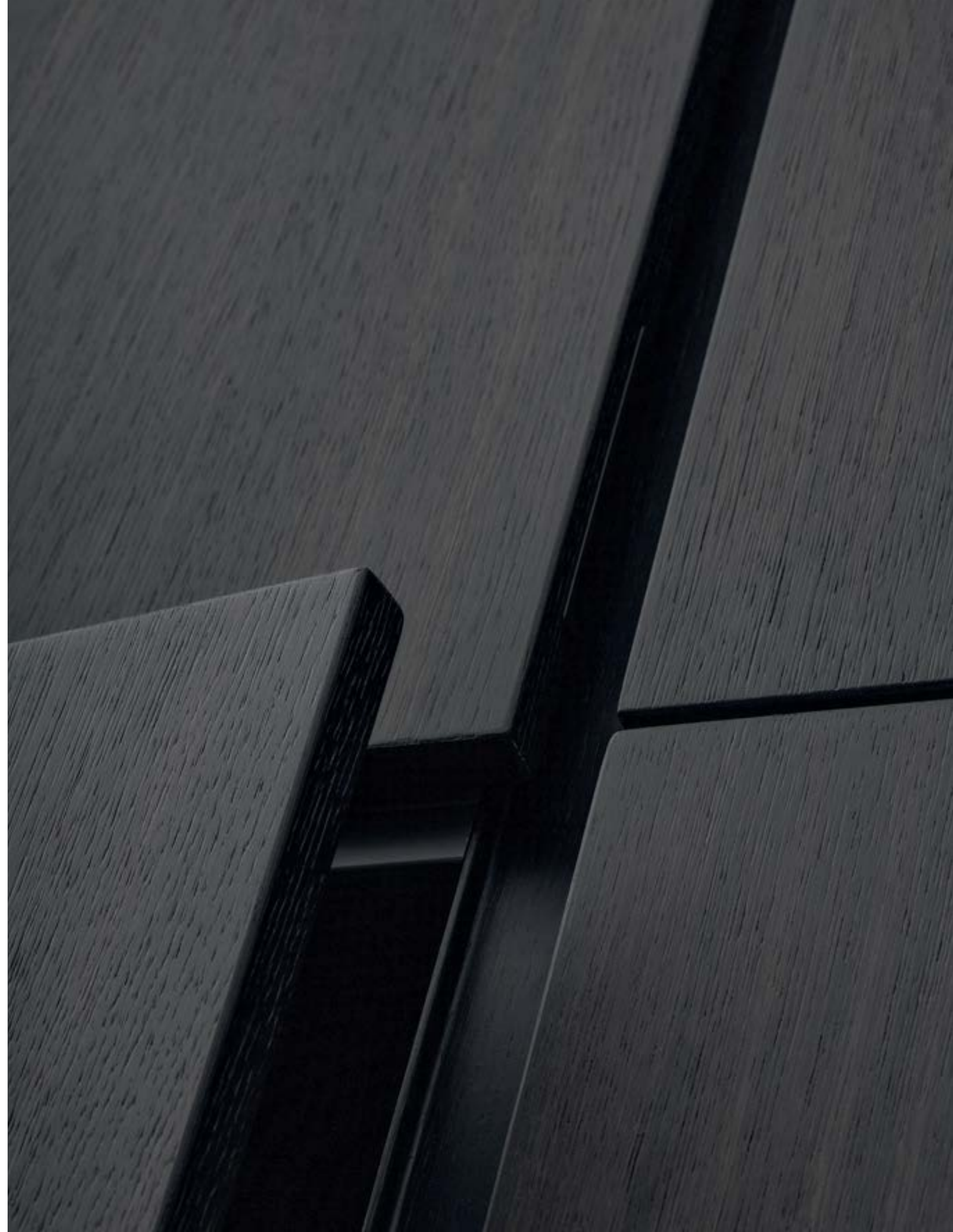





Qui e nelle pagine precedenti: isola con piano snack, basi con ante in laccato gofrato ghiaccio e top in DuPont Corian® pearl gray. Basi con ante ed estrattori in rovere spessart, top e schienali in pietra stone brown levigata. Cappa Flat verniciata nera a isola personalizzata Poliform. Colonne con ante e vani a giorno in rovere spessart. Sgabelli lcs in rovere spessart.

Previous and this page: island with snack top, base units with doors in embossed lacquered ghiaccio, top in DuPont Corian® pearl gray. Base units with doors and pull-out storage baskets in spessart oak, top and back panels in stone brown mat finishing. Poliform personalized Flat island-hood painted black. Tall units with doors and open compartments in spessart oak. lcs stools in spessart oak.

A destra: basi dell'isola con ante in laccato goffrato ghiaccio, top in DuPont Corian® pearl gray. Colonne con ante in rovere spessart. Sotto: vano attrezzato con ante a scomparsa e illuminazione a led integrata.

To the right: island base units with doors in embossed lacquered ghiaccio, top in DuPont Corian® pearl gray. Tall units with doors in spessart oak. Below: equipped element with pocket doors and integrated led lighting.

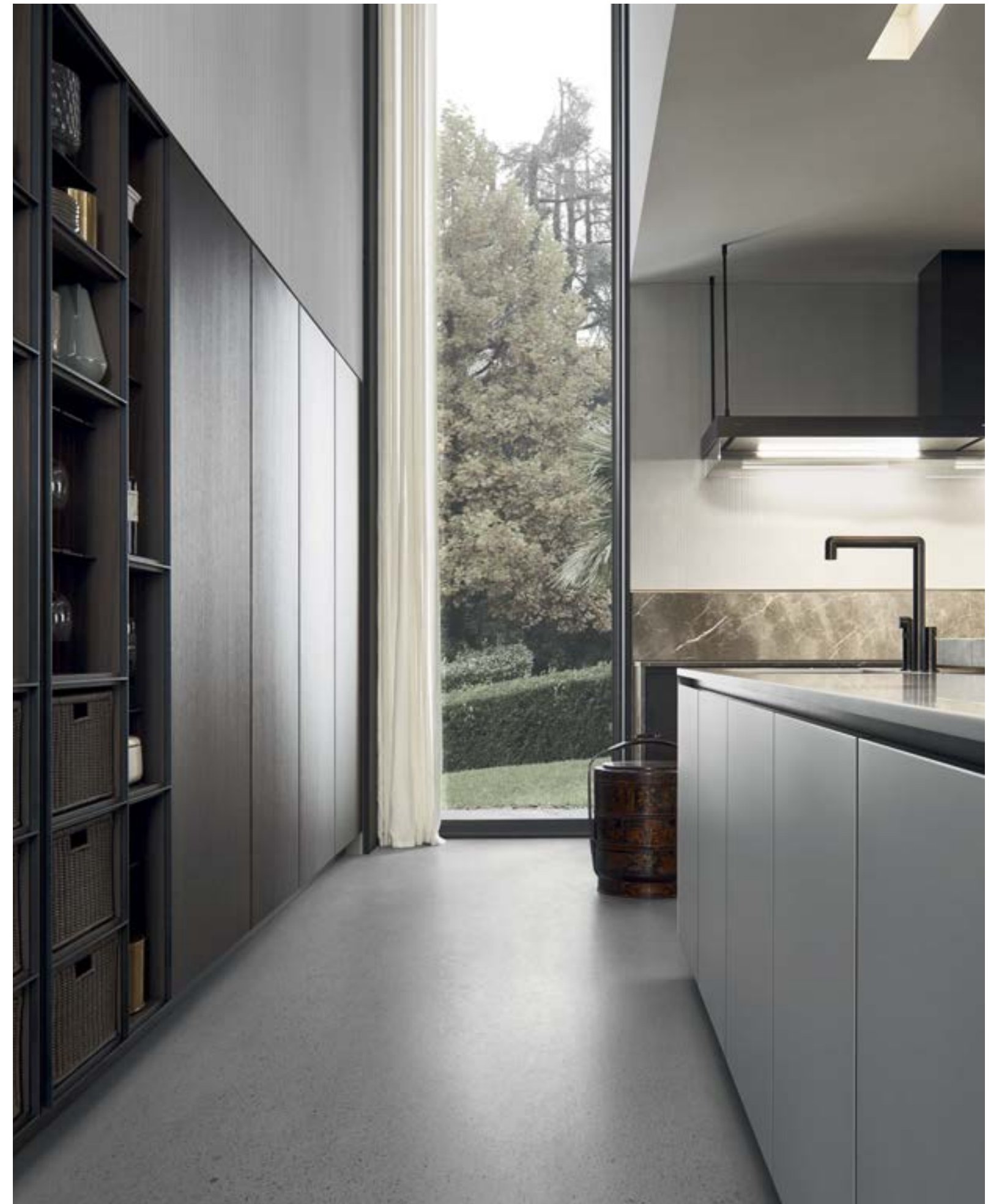



Due dettagli delle colonne in rovere spessart e profilo in alluminio laccato carbone. Cesti estraibili in midollino. Sgabello lcs in rovere spessart.

Two close-ups of the tall units with a spessart oak finishing and carbone lacquered aluminium profile. Pull-out wicker baskets. lcs stool in spessart oak.







Nelle pagine precedenti: isola con piano snack, basi con ante in laccato goffrato ghiaccio e top in DuPont Corian® pearl gray. Basi con ante ed estrattori in rovere spessart, top e schienali in pietra stone brown levigata. Cappa Flat verniciata nera a isola personalizzata Poliform. Pensili con ante vetrina PR22 in vetro riflettente fumé e telaio in alluminio anodizzato nero. A sinistra: estrattore con anta laccato goffrato ghiaccio. Cassetti interni verniciati brown con sistema di illuminazione interna a led e attrezzatura in wengé. Sotto: dettaglio del profilo di apertura con sagoma in alluminio laccato carbone.

Previous pages: island with snack top, base units with doors in embossed lacquered ghiaccio and top in DuPont Corian® pearl gray. Base units with doors and pull-out storage baskets in spessart oak, top and back panels in stone brown mat finishing. Poliform personalized Flat island-hood painted black. Wall units with doors PR22 in fumé reflecting glass and frame in black anodized aluminium. To the left: pull-out storage basket with door in embossed lacquered ghiaccio. Inner drawers painted brown with inner led lighting system and equipment in wenge. Below: close-up of the opening profile in carbone mat lacquered aluminium.





Nelle pagine precedenti: isola con piano snack, basi con ante in laccato goffrato ghiaccio e top in DuPont Corian® pearl gray. Basi con ante ed estrattori in rovere spessart, top e schienali in pietra stone brown levigata. Pensili con ante vetrina PR22 in vetro riflettente fumé e telaio in alluminio anodizzato nero. A destra: top e schienali in pietra stone brown levigata. Piani cottura Miele Smart Line a induzione con piastra Teppan Yaki in acciaio e vetroceramica. Lavello Foster in finitura KE Gun Metal. Cappa Flat verniciata nera a isola personalizzata Poliform.

Previous pages: island with snack top, base units with doors in embossed lacquered ghiaccio and top in DuPont Corian® pearl gray. Base units with doors and pull-out storage baskets in spessart oak, top and back panels in stone brown mat finishing. Wall units with doors PR22 in fumé reflecting glass and frame in black anodized aluminium. To the right: top and back panels in stone brown mat finishing. Induction hobs Miele Smart Line with Teppan Yaki griddle in steel and glass ceramics. Sink Foster in KE Gun Metal finish. Poliform personalized Flat island-hood painted black.





A sinistra: basi con ante ed estrattori in rovere spessart, top e schienali in pietra stone brown levigata. Pensili con ante vetrina PR22 in vetro riflettente fumé e telaio in alluminio anodizzato nero. Sotto: particolare dell'anta dei pensili.

To the left: base units with doors and pull-out storage baskets in spessart oak, top and back panels in stone brown mat finishing. Wall units with doors PR22 in fumé reflecting glass and frame in black anodized aluminium. Below: close-up of wall unit door.



A destra: dettaglio degli estrattori in verniciato brown con sistema di illuminazione interna a led e attrezzatura in wengé. Sotto: particolare del profilo d'apertura con sagoma in alluminio laccato carbone.

To the right: close-up of pull-out storage baskets painted brown with inner led lighting system and equipment in wengé. Below: close-up of carbone lacquered aluminium handle profile.



ALEA

Design R&D Poliform

Basi p 740

Strutture: nobilitato grigio lavagna.
Ante ed estrattori: rovere spessart.
Maniglie: sagoma alluminio laccato carbone.
Top, schienali e fianchi: pietra stone brown levigata, spessore 20 mm.
Zoccoli: alluminio laccato carbone.

Isola p 1040

Strutture: nobilitato grigio lavagna.
Top: DuPont Corian® pearl gray, spessore 20 mm.
Ante ed estrattori: laccato goffrato ghiaccio.
Maniglie: sagoma alluminio laccato carbone.
Fianchi: laccato goffrato ghiaccio, spessore 6 mm.
Zoccoli: alluminio laccato carbone.

Colonne p 740

Strutture: nobilitato grigio lavagna.
Ante: rovere spessart.
Fianchi: rovere spessart, spessore 20 mm.
Distanziatori verticali: rovere spessart.
Zoccoli: alluminio laccato carbone.

Pensili vetrina PR22 p 410

Strutture: nobilitato grigio lavagna.
Ante: vetro riflettente fumé con telaio alluminio anodizzato nero.
Aperture: pieghevole con profilo luminoso, a ribalta con apertura tip-on.
Fianchi: laccato goffrato carbone, spessore 6 mm.

Complementi

Sgabello Ics: rovere spessart.

Base units d 29 1/4"

Structures: grey lavagna melamine.
Doors and pull-out storage baskets: spessart oak.
Handles: carbone lacquered aluminium profile.
Top, back panels and side panels: stone brown mat finishing, thickness 3/4".
Plinths: carbone lacquered aluminium.

Island d 41"

Structures: grey lavagna melamine.
Top: DuPont Corian® pearl gray, thickness 3/4".
Doors and pull-out storage baskets: embossed lacquered ghiaccio.
Handles: carbone lacquered aluminium profile.
Side panels: embossed lacquered ghiaccio, thickness 1/4".
Plinths: carbone lacquered aluminium.

Tall units d 29 1/4"

Structures: grey lavagna melamine.
Doors: spessart oak.
Side panels: spessart oak, thickness 3/4".
Vertical spacers: spessart oak.
Plinths: carbone lacquered aluminium.

Glass wall units PR22 d 16 1/4"

Structures: grey lavagna melamine.
Doors: fumé reflecting glass with frame in black anodized aluminium.
Openings: folding with lighted profile, flap with tip-on opening.
Side panels: embossed lacquered carbone, thickness 1/4".

Accessories

Ics stool: spessart oak.

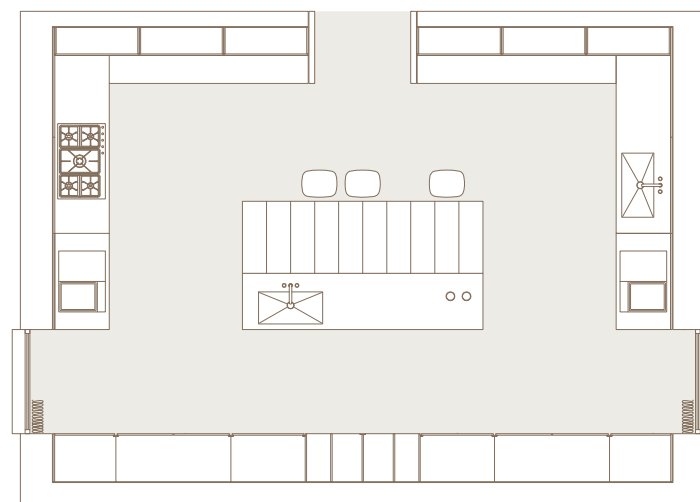
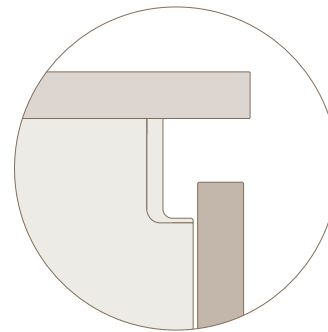

Basi Base units

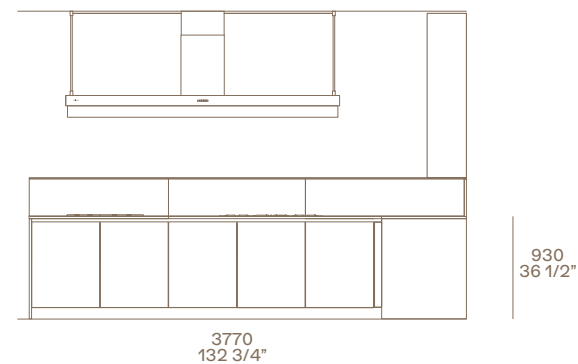

Isola Island

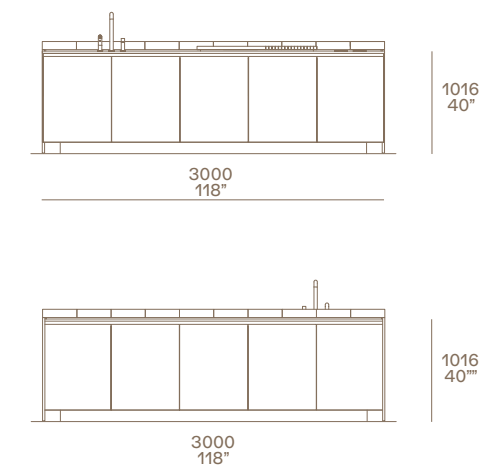

Colonne Tall units

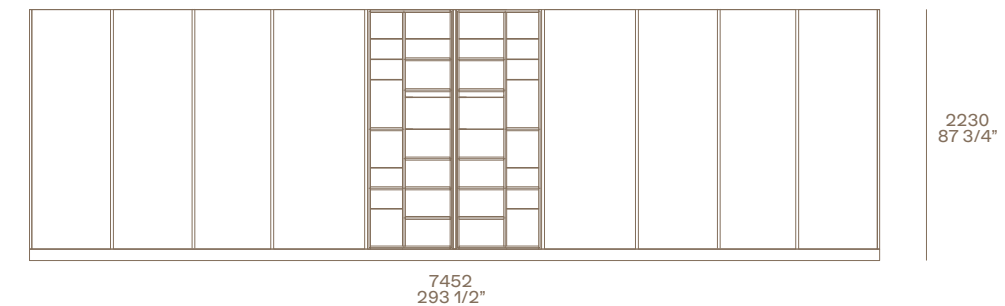

Pensili vetrina Glass wall units

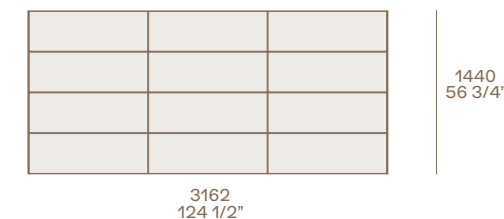

Ics Design Rodrigo Torres

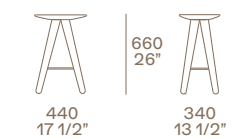

- 1 Piani cottura Miele Smart Line a induzione con piastra Teppan Yaki in acciaio e vetroceramica, incasso filotop.
- 2 Piano cottura 5 fuochi personalizzato Poliform by Barazza.
- 3 Attrezzatura in wengé e acciaio per cassetti interni.

- 4 Cappa Flat verniciato nero a isola personalizzata Poliform.
- 5 Pensili vetrina PR 22, apertura pieghevole con profilo luminoso, a ribalta con apertura tip-on.

- 6 Lavello finitura KE Gun Metal, incasso sottotop.
- 7 Attrezzatura in wengé e acciaio per estrattori.

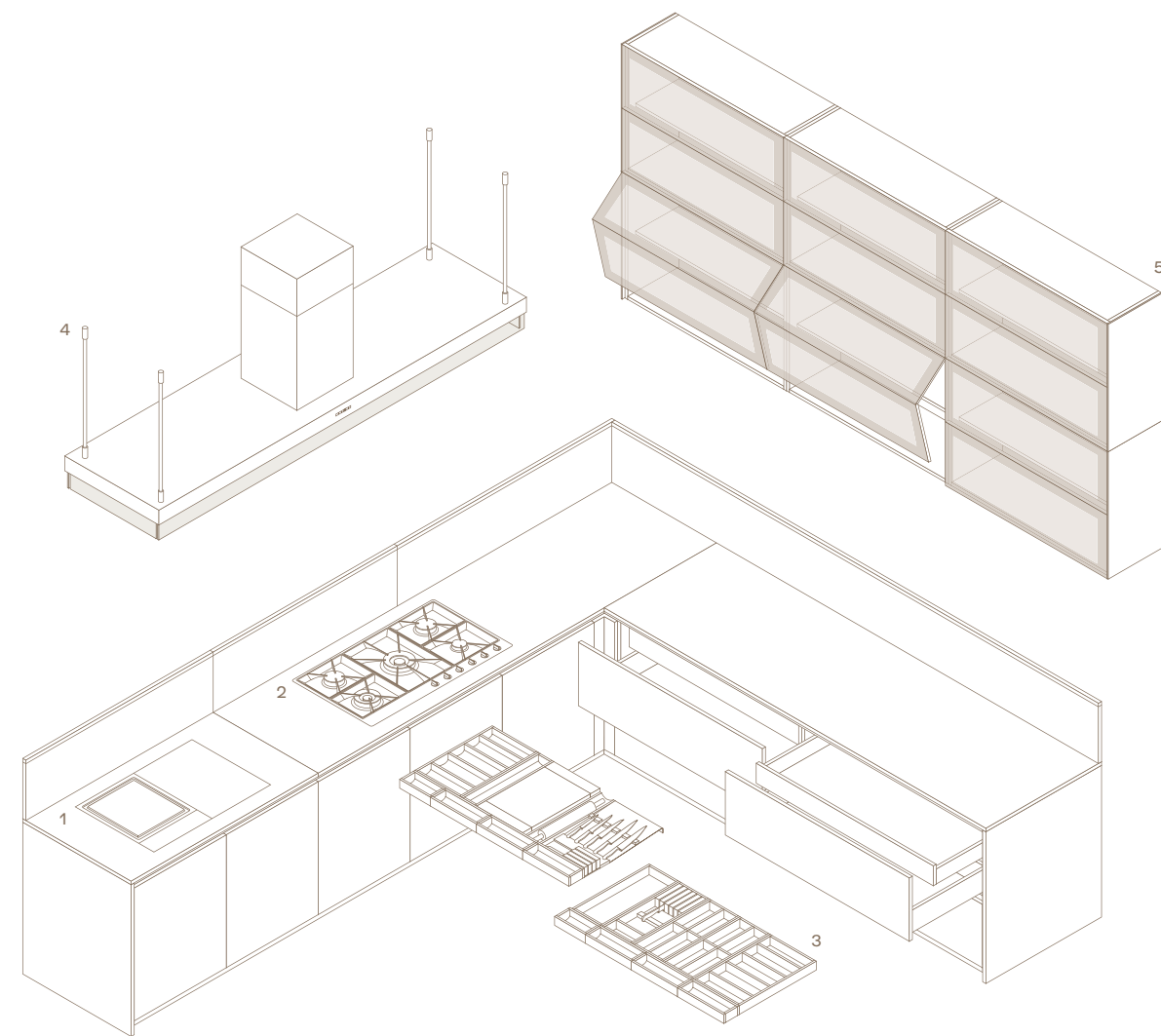

- 1 Induction hobs Miele Smart Line with Teppan Yaki griddle in steel and glass ceramics, flush built-in.
- 2 Personalized hob with 5 burners Poliform by Barazza.
- 3 Equipment for inner drawers in wenge and steel.

- 4 Poliform personalized Flat island-hood painted black.
- 5 Wall units with glass doors PR22, flap opening with lighted profile and tip-on opening.

- 6 Sink with KE Gun Metal finishing, under-top-mounted built-in.
- 7 Equipment for pull-out storage baskets in wenge and steel.

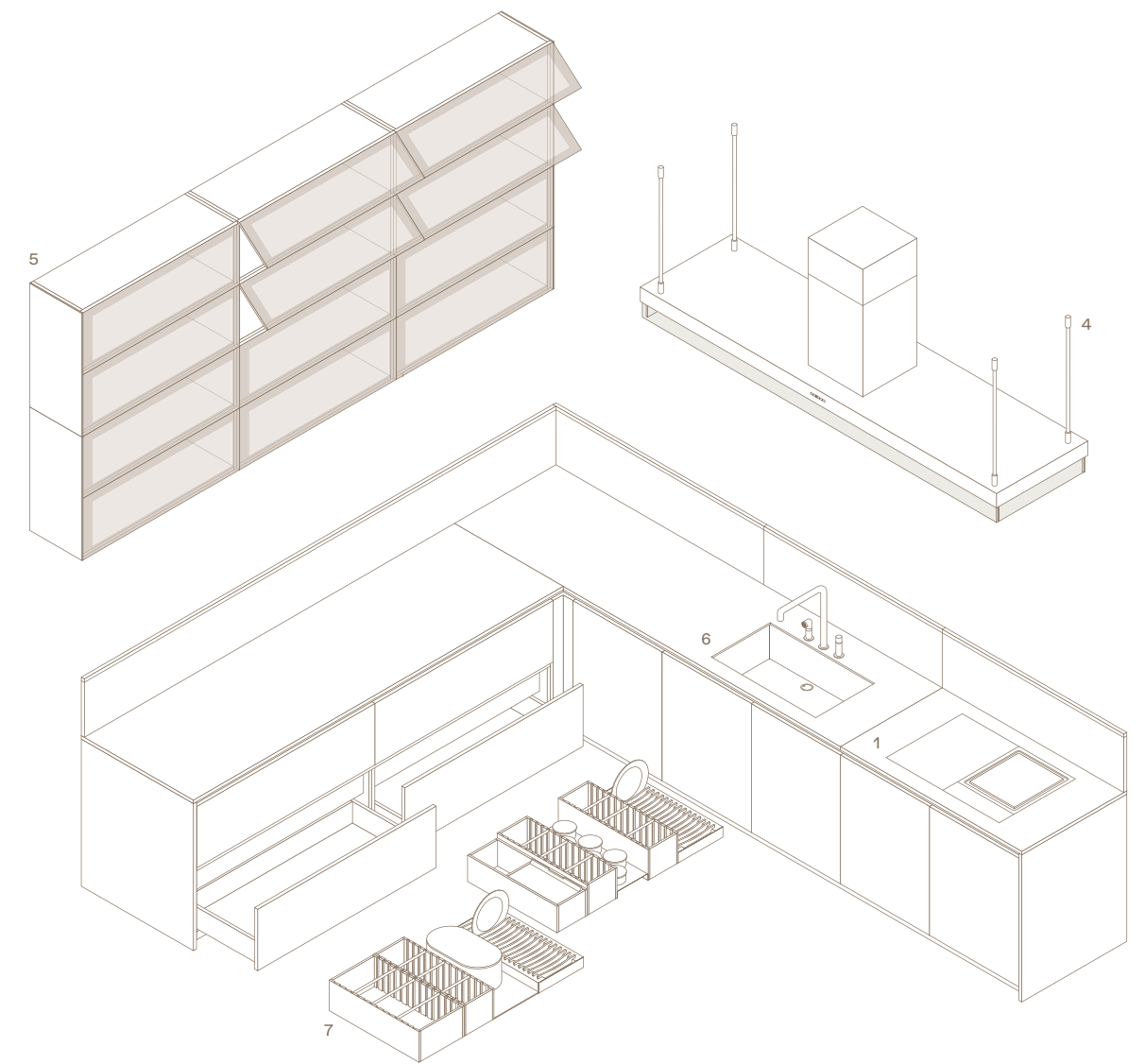

- 1 Lavello Foster finitura KE Gun Metal, incasso sottotop.
- 2 Piano snack profondità 900 mm.
- 3 Estrattore sottolavello con portarifiuti.

- 4 Attrezzatura in wengé e acciaio per cassetti interni.
- 5 Attrezzatura in wengé e acciaio per estrattori.

- 6 Colonna con ante a scomparsa, attrezzata con ripiani.
- 7 Colonna a giorno con cesti in midollino.
- 8 Colonna con ante a scomparsa, vani a giorno e forni.

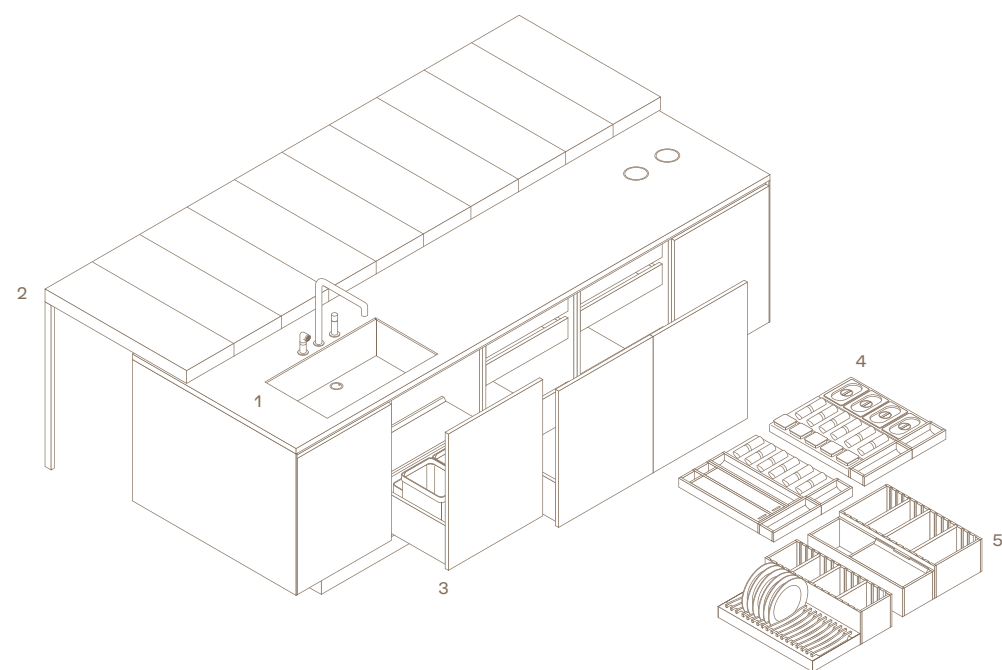

- 1 Sink Foster with KE Gun Metal finishing, under-top-mounted built-in.
- 2 Snack table depth 35 1/2".
- 3 Pull-out storage basket with under-sink waste bin.

- 4 Equipment for inner drawers in wengé and steel.
- 5 Equipment for pull-out storage baskets in wengé and steel.

- 6 Tall unit with pocket doors, with shelves.
- 7 Open tall unit with wicker baskets.
- 8 Tall unit with pocket doors, open elements and oven.

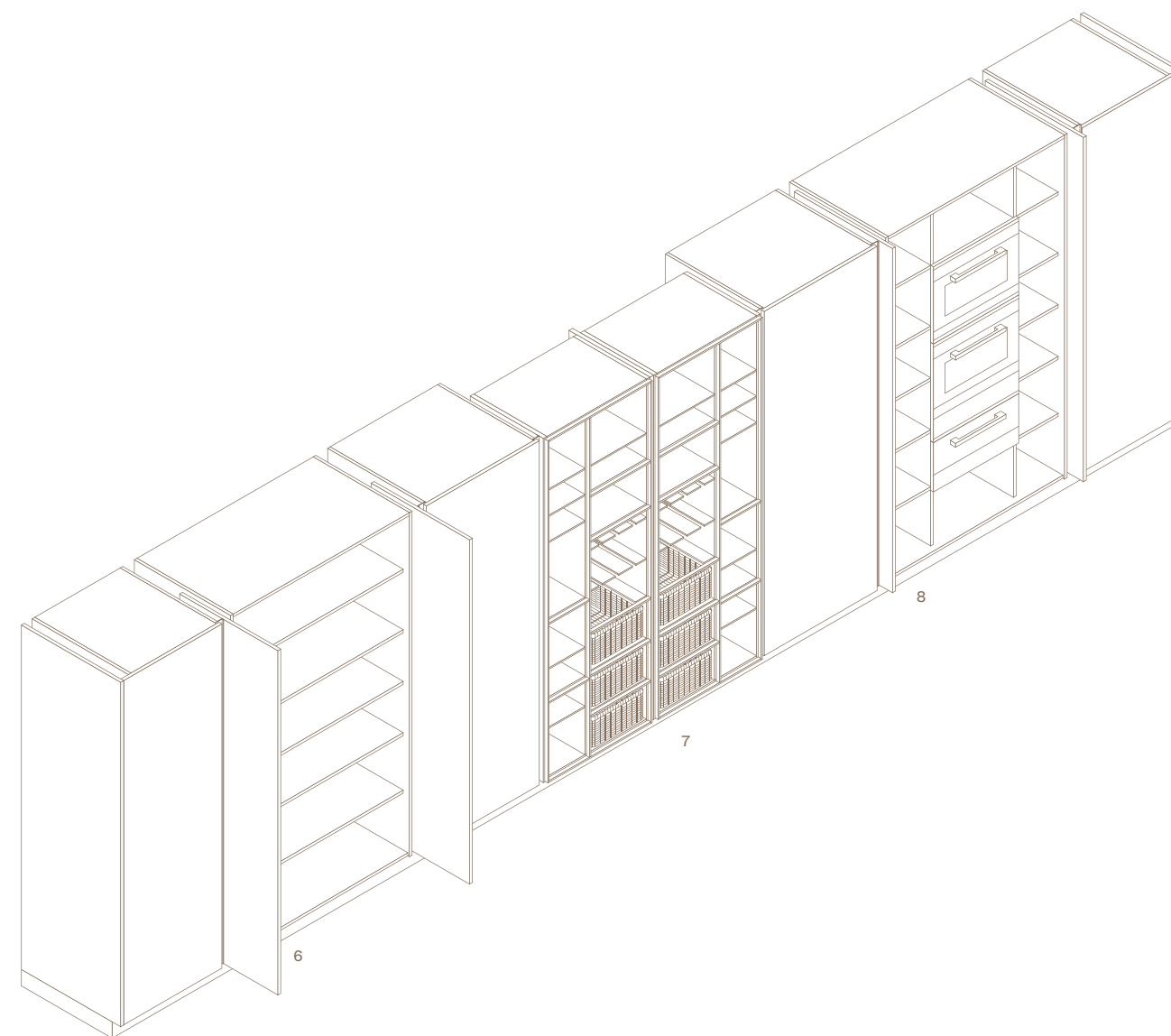

A destra: basi con ante, cassetti ed estrattori in nobilitato larice sabbia, top in laminato tuttocolore touch nero. Shaker con ripiani in alluminio anodizzato moka e tubi in laccato goffrato carbone. Mensola sopra Shaker in laccato goffrato carbone. Schienali in laminato tuttocolore touch nero.

To the right: base units with doors, drawers and pull-out storage baskets in larch sabbia melamine, top in laminate tuttocolore touch nero. Shaker with shelves in moka anodized aluminium and bars in embossed lacquered carbone. Shelf above Shaker in carbone embossed lacquered finishing. Backs in laminate tuttocolore touch nero.







Nelle pagine precedenti: basi con ante, cassetti ed estrattori in nobilitato larice sabbia, top in laminato tuttocolore touch nero. Pensili con ante nobilitato silk bronzo. Shaker con schienali in laccato goffrato carbone, ripiani in alluminio anodizzato moka e tubi in laccato goffrato carbone. Mensola sopra Shaker in laccato goffrato carbone. Schienali in laminato tuttocolore touch nero. A sinistra: dettaglio del pensile in nobilitato silk bronzo con ripiani interni in nobilitato grigio lavagna.

Previous pages: base units with doors, drawers and pull-out storage baskets in larch sabbia melamine, top in laminate tuttocolore touch nero. Wall units with doors in bronzo silk melamine. Shaker with back panels in embossed lacquered carbone, shelves in moka anodized aluminium and bars in embossed lacquered carbone. Shelf above Shaker in carbone embossed lacquered finishing. Backs in laminate tuttocolore touch nero. To the left: close-up of the wall unit in bronzo silk melamine with inner shelves in grey lavagna melamine.



Nelle pagine precedenti: basi con ante, cassetti ed estrattori in nobilitato larice sabbia, top in laminato tuttocolore touch nero. Pensili con ante nobilitato silk bronzo. Shaker con schienali in laccato goffrato carbone, ripiani in alluminio anodizzato moka e tubi in laccato goffrato carbone. Mensola sopra Shaker in laccato goffrato carbone. Schienali in laminato tuttocolore touch nero. A destra e sotto: dettagli dell'interno di cassetti ed estrattori con sistema di illuminazione a led. Attrezzatura in noce canaletto e alluminio anodizzato moka con piattai, portaposate, portacoltelli e portaspezie in ceramica.

Previous pages: base units with doors, drawers and pull-out storage baskets in larch sabbia melamine, top in laminate tuttocolore touch nero. Wall units with doors in bronzo silk melamine. Shaker with back panels in embossed lacquered carbone, shelves in moka anodized aluminium and bars in embossed lacquered carbone. Shelf above Shaker in carbone embossed lacquered finishing. Backs in laminate tuttocolore touch nero. To the right and below: close-up of inner drawers and pull-out storage basket with led lighting system. Inner equipment in walnut canaletto and moka anodized aluminium with plate holder, cutlery canteen, knife rack and spice holders in ceramic.





A sinistra: basi con ante, cassetti ed estrattori in nobilitato larice sabbia, top e schienali in laminato tuttocolore touch nero. Top con lavelli integrati in laminato tuttocolore touch nero, piano cottura a cinque fuochi in acciaio scotch brite personalizzato Poliform by Barazza. Pensili con ante in nobilitato silk bronzo. Shaker con ripiani in alluminio anodizzato moka e tubi laccato goffrato carbone, contenitori in DuPont Corian® glacier white. Mensola sopra Shaker in laccato goffrato carbone. Sotto: top con lavello integrato in laminato tuttocolore touch nero e fondo in acciaio scotch brite. Estrattori in nobilitato larice sabbia con sistema di illuminazione interna a led.

To the left: base units with doors, drawers and pull-out storage baskets in larch sabbia melamine. Worktop and backs in laminate tuttocolore touch nero. Top with integrated sinks in laminate tuttocolore touch nero, personalized hob Poliform by Barazza with five burners in scotch brite steel. Wall units with doors in bronzo silk melamine. Shaker with shelves in moka anodized aluminium and bars, holders in DuPont Corian® glacier white. Shelf above Shaker in carbone embossed lacquered. Below: worktop with integrated sink in laminate tuttocolore touch nero and bottom in scotch brite steel. Pull-out storage baskets in larch sabbia melamine with inner led lighting system.





A sinistra: colonne ed estrattori in nobilitato silk bronzo. Tavolo Concorde in rovere spessart con piano in marmo calacatta oro e piano girevole opzionale in rovere spessart. Sedie Grace in rovere spessart rivestite in tessuto Olimpia 112 prugna. Pouf Play in velluto Persia 1401 oliva.

To the left: tall units and pull-out storage baskets in bronzo silk melamine. Concorde table in spessart oak, top in calacatta oro marble and optional swivel top in spessart oak. Grace chairs in spessart oak with fabric covering Olimpia 112 prugna. Play pouf in velvet Persia 1401 oliva.





Nelle pagine precedenti: colonne con ante vetrina PR19 in vetro riflettente bronzato con telaio in alluminio verniciato bronzo, ripiani interni in vetro riflettente bronzato, illuminazione a led. Tavolo Concorde in rovere spessart con piano in marmo calacatta oro e piano girevole opzionale in rovere spessart. Sedie Grace in rovere spessart e rivestimento in tessuto Olimpia 112 prugna. Pouf Play in velluto Persia 1401 oliva. A sinistra: dettaglio delle ante vetrina PR19 in vetro riflettente bronzato con telaio in alluminio verniciato bronzo, apertura tip-on.

Previous pages: tall units with bronzed reflecting glass doors PR19, frame in bronzo painted aluminium, inner shelves in bronzed reflecting glass, led lighting. Concorde table in spessart oak, top in calacatta oro marble and optional swivel top in spessart oak. Grace chairs in spessart oak with fabric covering Olimpia 112 prugna. Play pouf in velvet Persia 1401 oliva. To the left: close-up of the glass doors PR19 in bronzed reflecting glass with frame in bronzo painted aluminium.

ALEA

Design R&D Poliform

Basi p 740

Strutture: nobilitato grigio lavagna.
Ante, cassetti ed estrattori:
nobilitato larice sabbia.
Top: laminato tuttocolore touch
nero, 20 e 52 mm.
Fianchi: nobilitato larice sabbia.
Schienali: laminato tuttocolore touch nero.
Zoccoli: laccato goffrato silk bronzo.

Colonne p 640

Strutture: nobilitato grigio lavagna.
Ante: nobilitato silk bronzo.
Distanziatori verticali e zoccoli:
laccato goffrato silk bronzo.

Pensili p 410

Strutture: nobilitato grigio lavagna.
Ante: nobilitato silk bronzo.
Aperture: battente con profilo luminoso.
Fianchi: nobilitato silk bronzo.
Ripiani: nobilitato grigio lavagna,
spessore 18 mm.

Pensili vetrina PR19 p 410

Strutture: nobilitato grigio lavagna.
Ante: vetro riflettente bronzato con telaio
alluminio verniciato bronzo
Aperture: tip-on.
Ripiani interni: vetro riflettente bronzato.

Shaker p 120

Strutture: alluminio anodizzato moka.
Ripiani e tubi: laccato goffrato
carbone.
Mensola: laccato goffrato carbone,
spessore 52 mm.

Complementi

Tavolo Concorde: struttura e piano
girevole in rovere spessart, piano in marmo
calacatta oro opaco.
Sedia Grace: seduta in tessuto Olimpia
112 prugna, gambe in rovere spessart.
Pouf Play: velluto Persia 1401 oliva.

Base units d 29 1/4"

Structures: grey lavagna melamine.
Doors, drawers and pull-out baskets:
larch sabbia melamine.
Top: laminate tuttocolore touch nero,
thickness 3/4" and 2".
Sides: larch sabbia melamine.
Backs: laminate tuttocolore touch nero.
Plinths: bronzo silk embossed lacquered.

Tall units d 25 1/4"

Structures: grey lavagna melamine.
Doors: bronzo silk melamine.
Vertical spacers and plinths: bronzo silk
embossed lacquered.

Wall units d 16 1/4"

Structures: grey lavagna melamine.
Doors: bronzo silk melamine.
Openings: leaf with lighted profile.
Sides: bronzo silk melamine.
Shelves: grey lavagna melamine,
thickness 3/4".

Glass wall units d 16 1/4"

Structures: grey lavagna melamine.
Doors: bronzed reflecting glass with
bronzed painted aluminium frame.
Openings: tip-on.
Inner shelves: bronzed reflecting glass.

Shaker d 4 3/4"

Structures: moka anodized aluminium.
Shelves and bars: carbone embossed
lacquered.
Shelf: carbone embossed lacquered,
thickness 2".

Accessories

Concorde table: structure and swivel
top in spessart oak, top in calacatta oro
mat marble.
Grace chair: seat in fabric Olimpia 112
prugna, legs in spessart oak.
Play pouf: velvet Persia 1401 oliva.

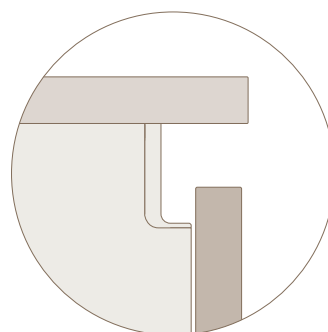

Basi e Shaker Base units and Shaker

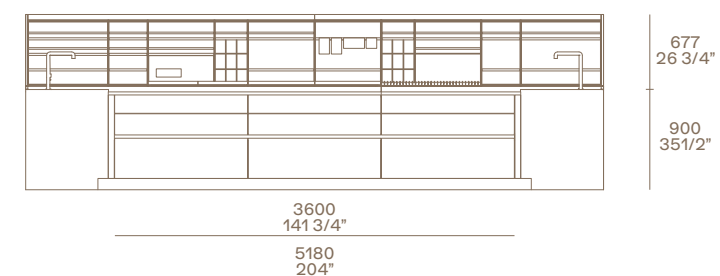

Basi e pensili Base units and wall units

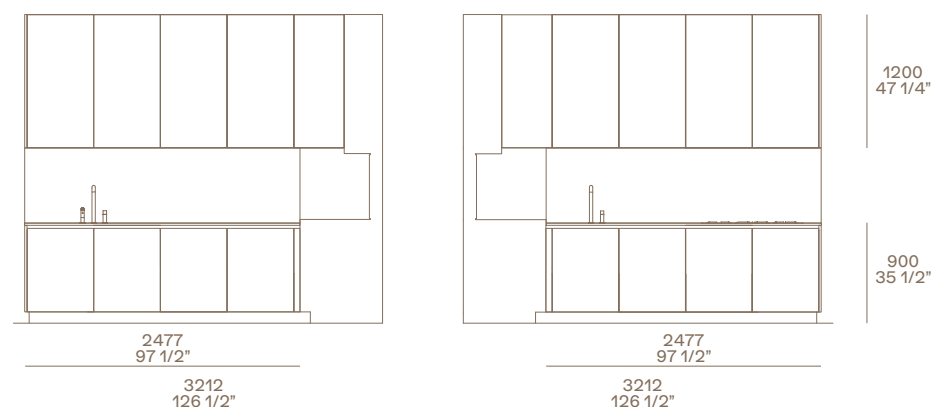

Pensili vetrina Glass wall units

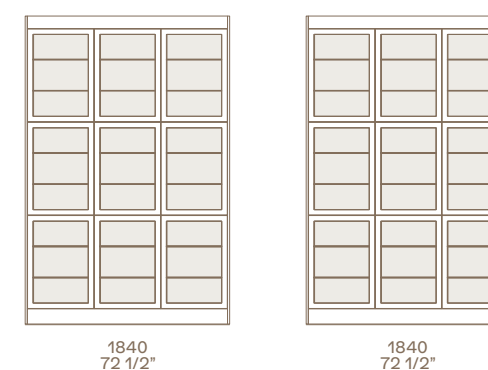

Colonne Tall units

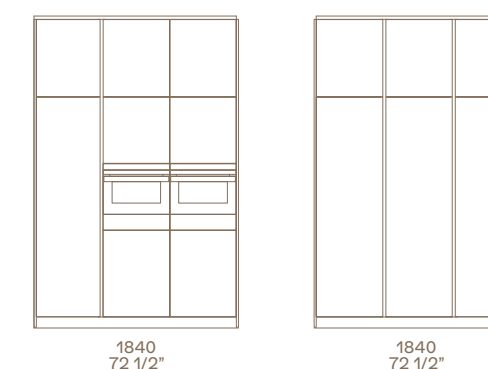

Grace Design Emmanuel Gallina

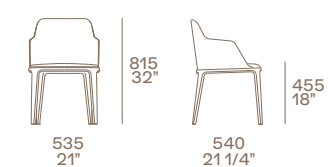

Concorde Design Emmanuel Gallina

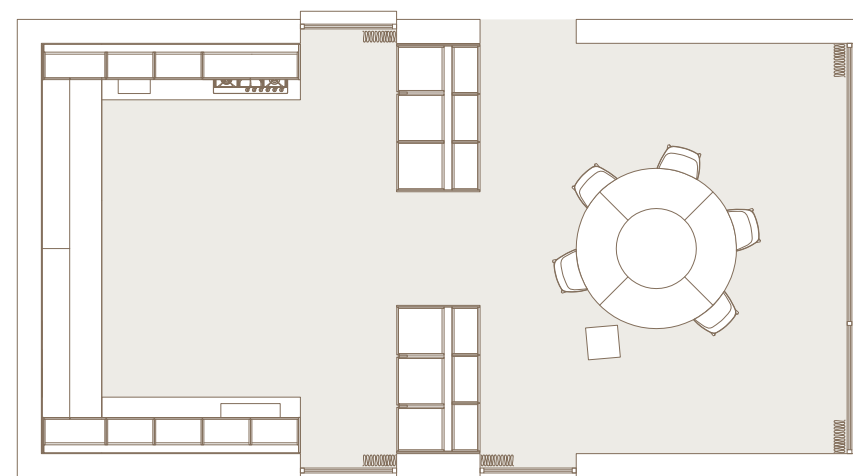
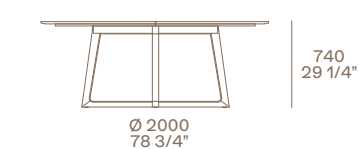

- 1 Lavello integrato in laminato tuttocolore touch nero con fondo acciaio scotch brite.
- 2 Piano cottura 5 fuochi personalizzato Poliform by Barazza, incasso filotop.
- 3 Attrezzatura in noce canaletto e alluminio anodizzato moka per cassetti ed estrattori.

- 4 Shaker con ripiani, vani a giorno, portabicchieri e contenitori.
- 5 Mensola profondità 405 mm.
- 6 Pensili con ante ad apertura battente.
- 7 Cappa a scomparsa in acciaio scotch brite personalizzata Poliform.

- 8 Colonne con forni, e frigo/congelatore con ante ad apertura battente ed estrattori.
- 9 Pensili vetrina PR19 con ante apertura tip-on e ripiani interni.

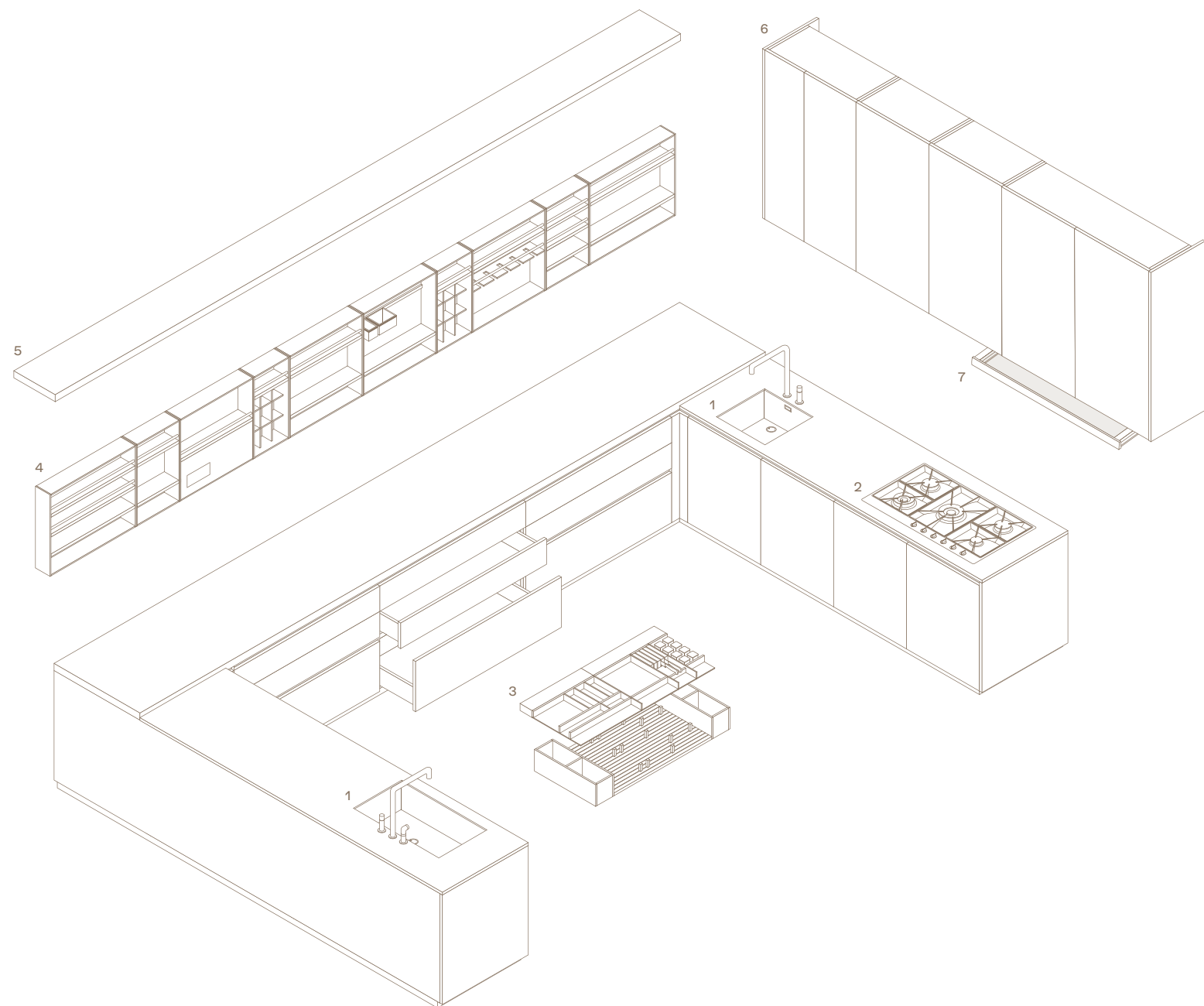

- 1 Integrated sink in laminate tuttocolore touch nero with bottom in scotch brite steel.
- 2 Personalized hob with 5 burners Poliform by Barazza, flush built-in.
- 3 Equipment in walnut canaletto and moka anodized aluminium for drawers and pull-out baskets.

- 4 Shaker with shelves, open units, glass holders and holders.
- 5 Shelf depth 16".
- 6 Wall units with leaf doors.
- 7 Personalized hidden hood Poliform in scotch brite steel.

- 8 Tall units with ovens, fridge and freezer with leaf doors and pull-out baskets.
- 9 Wall units with glass doors PR19 with tip-on opening and inner shelves.

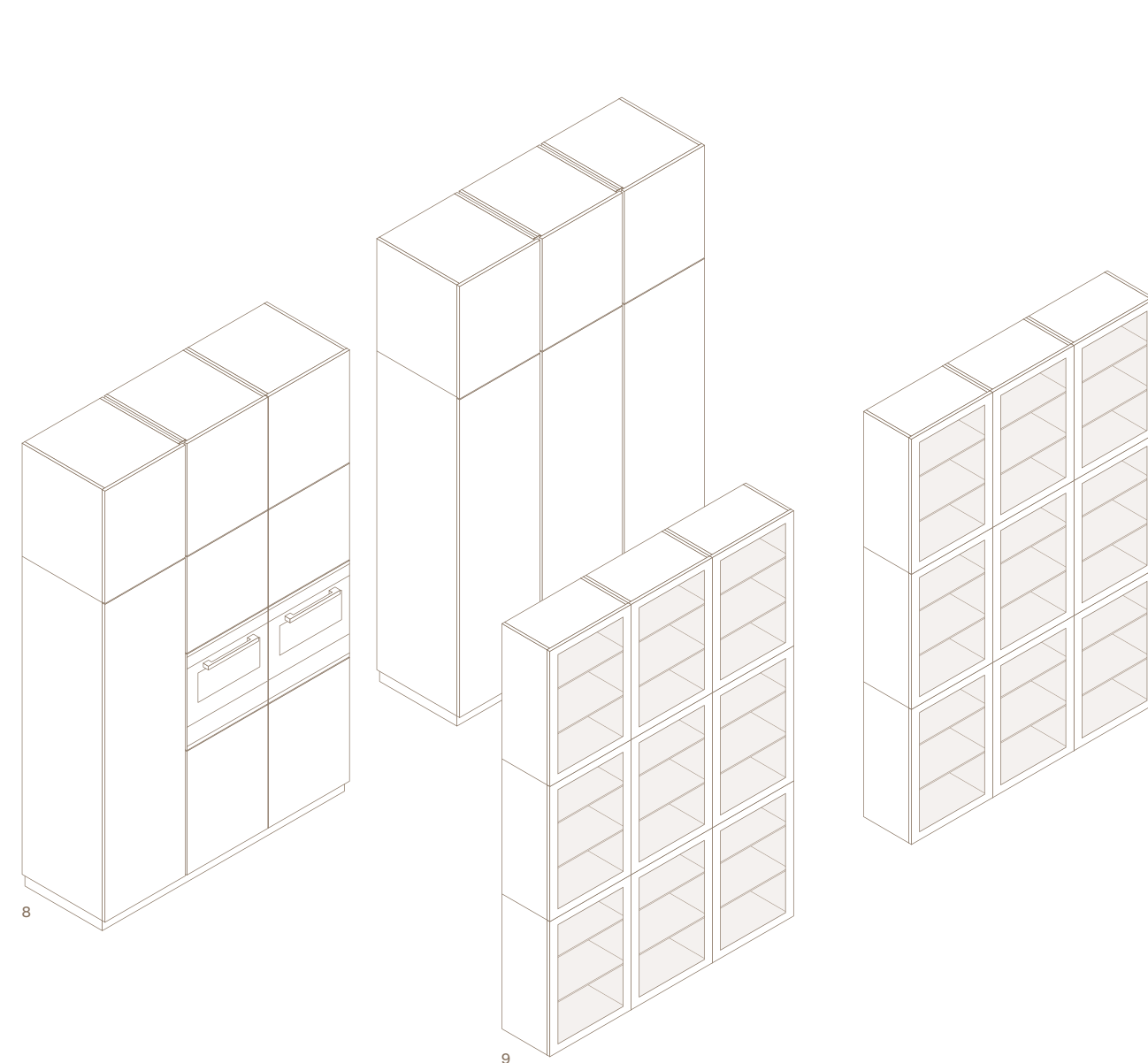

A destra: basi e isola con ante, cassetti ed estrattori in laminato touch bianco e top in laminato tuttocolore touch bianco con inserto colore nero. Cappa Flat a isola in acciaio scotch brite personalizzata Poliform. Mensola in laccato goffrato castoro con schienale in laminato tuttocolore touch castoro. Schienali in pietra fossena fiammata. Piano snack in rovere spessart. Sgabelli Ventura in olmo nero e pelle Soft 14 oliva.

To the right: base units and island with doors, drawers and pull-out storage baskets in laminate touch bianco and top in laminate tutto-colore touch bianco with insert in black colour. Poliform personalized island-hood Flat in scotch brite steel. Castoro embossed lacquered shelf with back in laminate tuttocolore touch castoro. Backs in fossena stone blaze. Snack top in spessart oak. Ventura stools in black elm and leather Soft 14 oliva.







Nelle pagine precedenti: basi e isola con ante, cassetti ed estrattori in laminato touch bianco e top in laminato tuttocolore touch bianco con inserto colore nero. Cappa Flat a isola in acciaio scotch brite personalizzata Poliform. Pensili e colonne con ante in laminato touch castoro. Mensola in laccato goffrato castoro con schienale in laminato tuttocolore touch castoro. Schienali in pietra fossena fiammata. Piano snack in rovere spessart. Sgabelli Ventura in olmo nero e pelle Soft 14 oliva. A sinistra: isola con ante ed estrattori laminato touch bianco. Top in laminato tuttocolore touch bianco con lavello integrato. Piani cottura Miele Smart Line a induzione con piastra Teppan Yaki in acciaio e vetroceramica. Cappa Flat a isola in acciaio scotch brite personalizzata Poliform.

Previous pages: base units and island with doors, drawers and pull-out storage baskets in laminate touch bianco and top in laminate tuttocolore touch bianco with insert in black colour. Poliform personalized island-hood Flat in scotch brite steel. Wall units and tall units with doors in laminate touch castoro. Castoro embossed lacquered shelf with back in laminate tuttocolore touch castoro. Backs in fossena stone blaze. Snack top in spessart oak. Ventura stools in black elm and leather Soft 14 oliva. To the left: island with doors and pull-out storage baskets laminate touch bianco. Worktop in laminate tuttocolore touch bianco with integrated sink. Induction hobs Miele Smart Line with Teppan Yaki griddle in steel and glass ceramics. Poliform personalized island-hood Flat in scotch brite steel.

A destra: basi e isola con ante, cassetti ed estrattori in laminato touch bianco. Top in laminato tuttocolore touch bianco con lavelli integrati. Piano cottura filotop a cinque fuochi personalizzato Poliform by Barazza e piani cottura Miele Smart Line a induzione con piastra Teppan Yaki in acciaio e vetroceramica. Cappa Flat a isola in acciaio scotch brite personalizzata Poliform.

To the right: base units and island with doors, drawers and pull-out storage baskets in laminate touch bianco. Worktop in laminate tutto-colore touch bianco with integrated sinks. Personalized built-in hob with five burners Poliform by Barazza and induction hobs Miele Smart Line with Teppan Yaki griddle in steel and glass ceramics. Poliform personalized island-hood Flat in scotch brite steel.







Nelle pagine precedenti: basi e isola con ante, cassetti ed estrattori in laminato touch bianco. Cappa Flat a isola in acciaio scotch brite personalizzata Poliform. Pensili e colonne con ante laminato touch castoro. Schienali in pietra fossena fiammata. Piano snack in rovere spessart. Sgabelli Ventura in olmo nero e rivestimento in pelle Soft 14 oliva. A sinistra: estrattore con sistema di illuminazione interna a led. Cassetto interno verniciato brown e attrezzatura in noce canaletto e alluminio anodizzato moka. Sotto: dettaglio dell'estrattore in laminato touch bianco, con piattiaia e attrezzatura interna in noce canaletto e alluminio anodizzato moka.

Previous pages: base units and island with doors, drawers and pull-out storage baskets in laminate touch bianco. Poliform personalized island-hood Flat in scotch brite steel. Wall units and tall units with doors in laminate touch castoro. Backs in fossena stone blaze. Snack top in spessart oak. Ventura stools in black elm and covering in leather Soft 14 oliva. To the left: pull-out storage basket with brown painted inner drawer with inner led lighting system. Inner equipment in walnut canaletto and moka anodized aluminium. Below: close-up of pull-out storage basket in laminate touch bianco, plate holder and inner equipment in walnut canaletto and moka anodized aluminium.

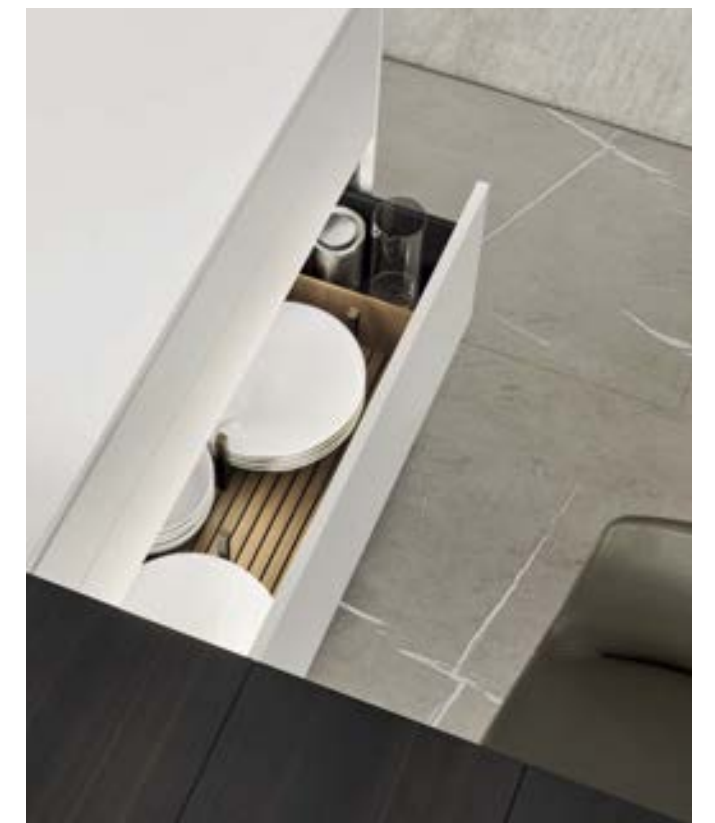



In questa pagina: basi e isola con ante, cassetti ed estrattori in laminato touch bianco e top in laminato tuttocolore touch bianco con inserto colore nero. Cappa Flat a isola in acciaio scotch brite personalizzata Poliform. Pensili e colonne con ante in laminato touch castoro. Mensola in laccato goffrato castoro con schienale in laminato tuttocolore touch castoro. Schienali in pietra fossena fiammata. Piano snack in rovere spessart. Sgabelli Ventura in olmo nero e pelle Soft 14 oliva. Sotto: dettaglio del top in laminato tuttocolore touch bianco con inserto colore nero.

This page: base units and island with doors, drawers and pull-out storage baskets in laminate touch bianco and top in laminate tuttocolore touch bianco with insert in black colour. Poliform personalized island-hood Flat in scotch brite steel. Wall units and tall units with doors in laminate touch castoro. Castoro embossed lacquered shelf with back in laminate tuttocolore touch castoro. Backs in fossena stone blaze. Snack top in spessart oak. Ventura stools in black elm and leather Soft 14 oliva. Below: close-up of the worktop in laminate tuttocolore touch bianco with insert in black colour.



ALEA

Design R&D Poliform

Basi e isola p 740 - 1270

Strutture: nobilitato grigio lavagna.
 Ante, cassetti ed estrattori: laminato touch bianco.
 Maniglie: sagoma laccato goffrato bianco.
 Top basi: laminato tuttocolore touch bianco, spessore 52 mm con inserto colore nero.
 Top isola: laminato tuttocolore touch bianco, spessore 20 mm.
 Schienali: pietra fossena fiammata, acciaio scotch brite e laminato tuttocolore touch castoro.
 Zoccoli: laccato goffrato carbone.

Mensole p 405

Top: laccato goffrato castoro, spessore 30 mm.
 Schienali: laminato tuttocolore touch castoro, spessore 20 mm.

Colonne p 640

Strutture: nobilitato grigio lavagna.
 Ante: laminato touch castoro.
 Maniglie: laccato goffrato castoro, incassate bordo anta.
 Zoccoli: laccato goffrato carbone.

Pensili p 410

Strutture: nobilitato grigio lavagna.
 Ante: laminato touch castoro.
 Aperture: a ribalta con profilo luminoso.

Snack

Rovere spessart.

Complementi

Sgabello Ventura: struttura in olmo nero e rivestimento in pelle Soft 14 oliva.

Base units and island d 29 1/4"- 50"

Structures: grey lavagna melamine.
 Doors, drawers and pull-out baskets: laminate touch bianco.
 Handles: bianco embossed lacquered profile.
 Base units top: laminate tuttocolore touch bianco, thickness 2" with insert in black.
 Island top: laminate tuttocolore touch bianco, thickness 3/4".
 Backs: fossena stone blaze, scotch brite steel and laminate tuttocolore touch castoro.
 Plinths: embossed lacquered carbone.

Shelves d 16"

Top: embossed lacquered castoro, thickness 1 1/4".
 Backs: laminate tuttocolore touch castoro, thickness 3/4".

Tall units d 25 1/4"

Structures: grey lavagna melamine.
 Doors: laminate touch castoro.
 Handles: embossed lacquered castoro, built-in in the door edge.
 Plinths: embossed lacquered carbone.

Wall units d 16 1/4"

Structures: grey lavagna melamine.
 Doors: laminate touch castoro.
 Openings: flap doors with lighted profile.

Snack top

Spessart oak.

Accessories

Ventura stool: structure in black elm and covering in leather Soft oliva 14.

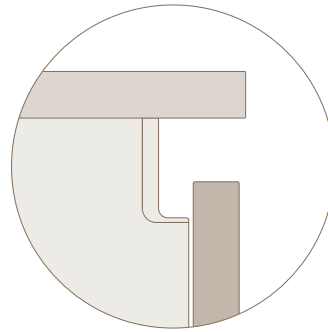

Isola Island

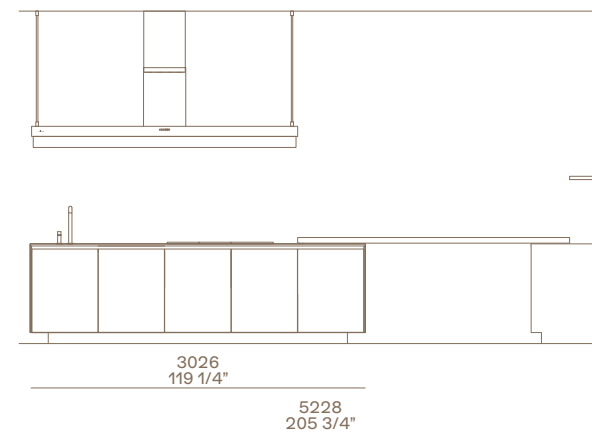

Colonne Tall units



Ventura

Design Jean-Marie Massaud

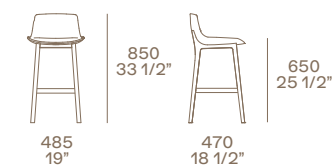

Basi e mensole Base units and shelves

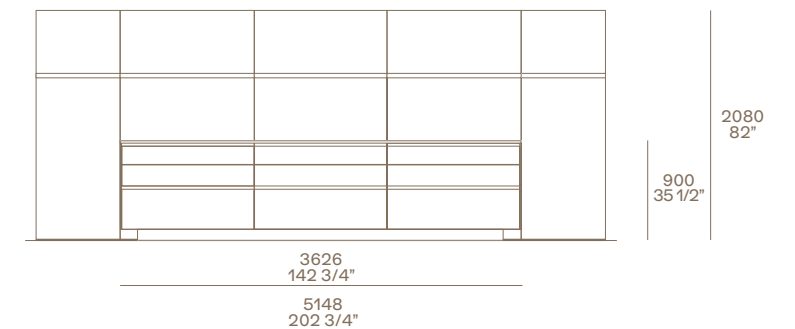

Basi e pensili Base units and wall units

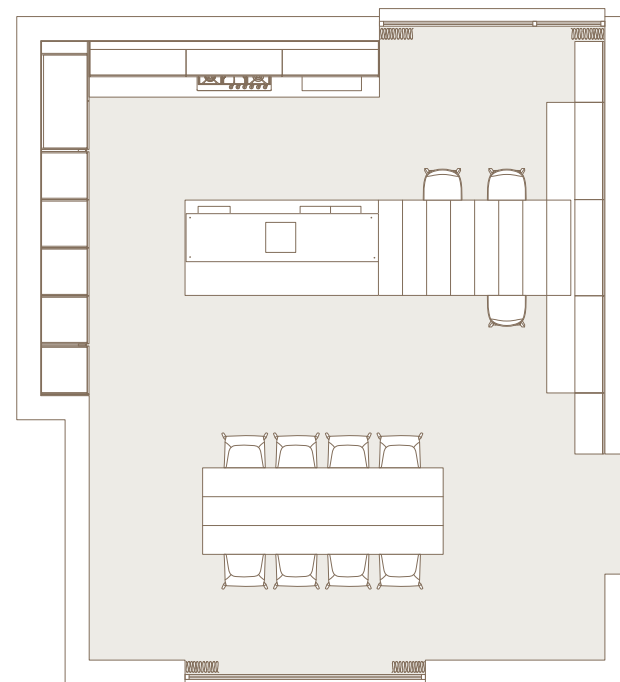
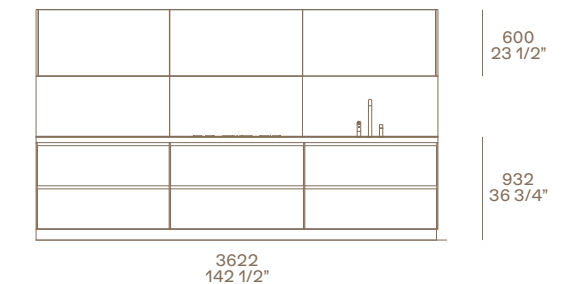

- 1 Colonne con forni, frigo/congelatore e macchina caffè da incasso standard con ante ad apertura battente ed estrattori.
- 2 Pensili con apertura a ribalta.
- 3 Cappa a scomparsa personalizzata Poliform.

- 4 Piano cottura acciaio scotch brite, 5 fuochi personalizzato Poliform by Barazza, incasso filotop.
- 5 Attrezzatura interna in noce canaletto e alluminio anodizzato moka.
- 6 Lavello integrato in laminato tuttocolore touch bianco con fondo acciaio scotch brite.

- 7 Piani cottura Miele Smart Line a induzione con piastra Teppan Yaki in acciaio e vetroceramica, incasso filotop.
- 8 Cappa Flat a isola in acciaio scotch brite personalizzata Poliform.
- 9 Piano snack 1270 x 2400.
- 10 Mensole profondità 405 mm.

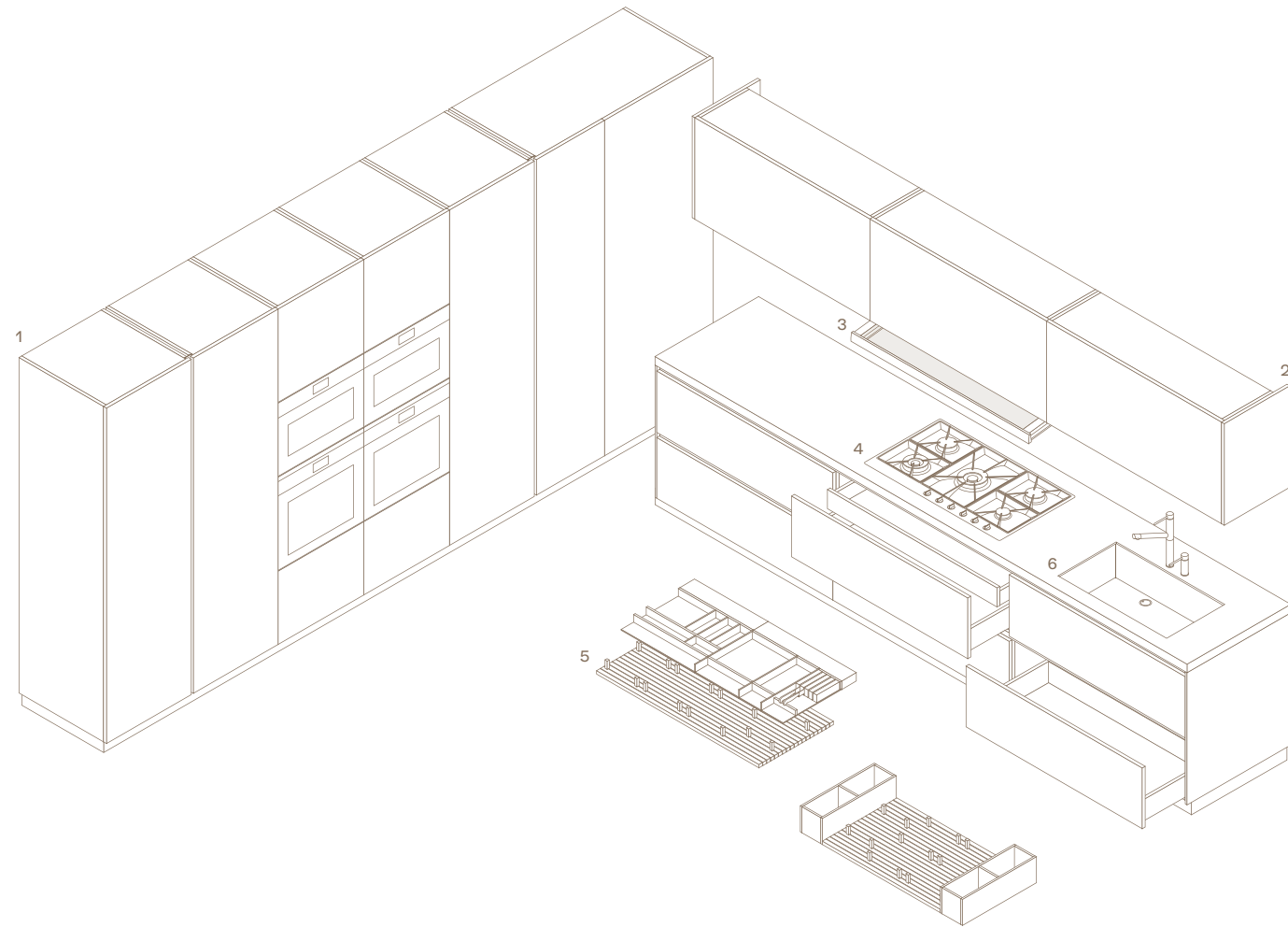

- 1 Tall units with ovens, fridge/freezer and standard built-in coffee machine with leaf doors and pull-out baskets.
- 2 Wall units with flap doors.
- 3 Poliform personalized hidden hood.

- 4 Hob in scotch brite steel with 5 burners personalized Poliform by Barazza, flush built-in.
- 5 Inner equipment in walnut canaletto and moka anodized aluminium.
- 6 Integrated sink in laminate tuttocolore touch bianco with bottom in scotch brite steel.

- 7 Induction hobs Miele Smart Line with Teppan Yaki griddle in steel and glass ceramics, flush built-in.
- 8 Poliform personalized island-hood Flat in scotch brite steel.
- 9 Snack top 50" x 94 1/2".
- 10 Shelves depth 16".

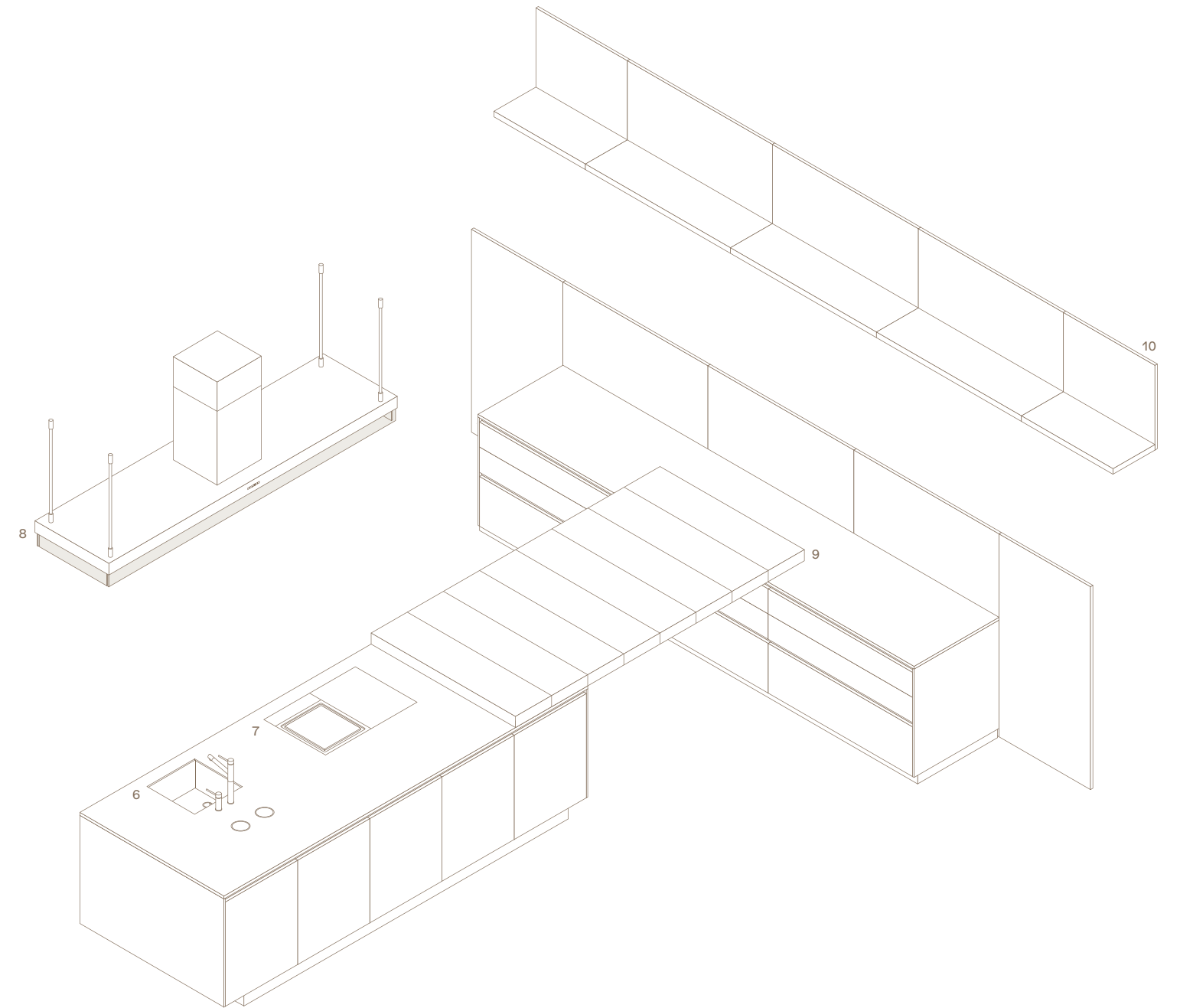



TRAIL

Con Trail, Carlo Colombo e Poliform rileggono in chiave contemporanea l'anta a telaio. Elemento caratterizzante è qui la maniglia integrata su tutta la larghezza dell'anta. Un dettaglio estetico di grande impatto visivo, sia quando usato nelle basi sia nelle colonne, anche in combinazione con le vetrine.

With Trail, Carlo Colombo and Poliform reinterpret the frame door with a contemporary approach. The characterising element here is the integrated handle over the entire of the door. An aesthetic detail of great visual impact, both when used in the base units and in the tall units, even in combination with the glass units.

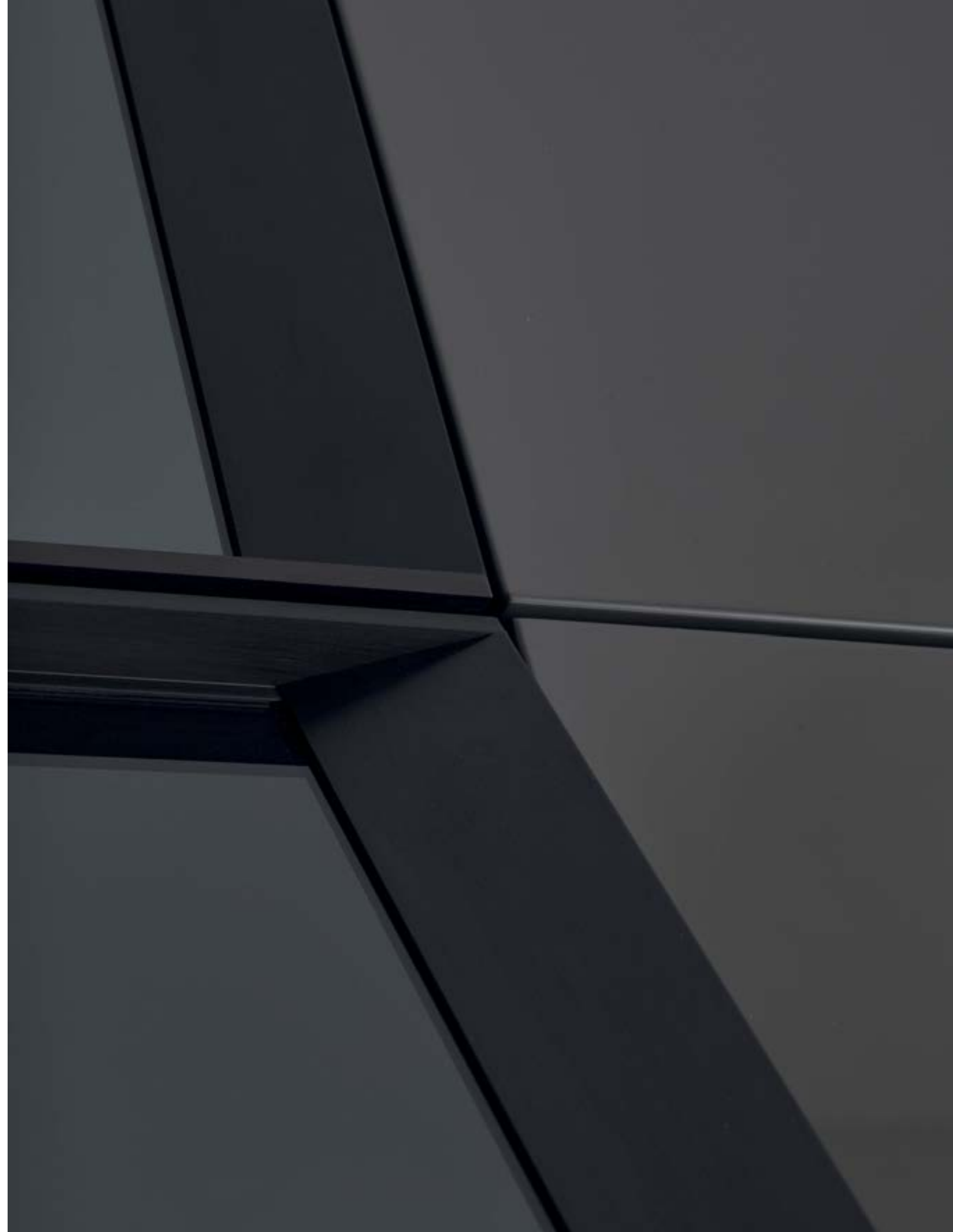



Qui e nelle pagine precedenti: basi con ante ed estrattori in laccato goffrato bianco, top in quarzite white sand micropallinata. In appoggio sulle basi, piano snack in rovere cenere. Cappa Work a parete in acciaio scotch brite e vetro. Pensili con ante vetrina PR21, telaio anodizzato moka e vetro riflettente fumé. Sgabelli lcs in rovere spessart.

This and previous pages: base units with bianco embossed lacquered doors and pull-out storage baskets, top in white sand micro-blasted composite stone. Snack top in cenere oak. Work wall-mounted hood in scotch brite steel and glass. Wall units with moka anodized doors PR21 and fumé reflecting glass. lcs stools in spessart oak.





A sinistra: pensili con ante vetrina PR21, telaio anodizzato moka e vetro riflettente fumé, con ripiani interni in vetro fumé. Basi con ante ed estrattori in laccato goffrato bianco, top e fianchi in quarzite white sand micropallinata. In appoggio sulle basi, piano snack in rovere cenere. Sotto: dettaglio delle ante vetrina PR21 con ripiani interni in vetro fumé.

To the left: wall units with moka anodized doors PR21 and fumé reflecting glass, with inner shelves in fumé glass. Base units with bianco embossed lacquered doors and pull-out storage baskets, top and side panels in white sand micro-blasted composite stone. Snack table in cenere oak. Below: close-up of glass doors PR21 with inner shelves in fumé glass.



A destra: basi con ante ed estrattori in laccato goffrato bianco con maniglia integrata Trail, top in quarzite white sand micropallinata. Cappa Work a parete in acciaio scotch brite e vetro. Pensili con ante vetrina PR21, telaio anodizzato moka e vetro riflettente fumé. Colonne con ante rovere cenere. Sotto: dettaglio del piano cottura filotop in acciaio scotch brite a cinque fuochi personalizzato Poliform by KitchenAid.

To the right: base units with bianco embossed lacquered doors and pull-out storage baskets with Trail integrated handle, top in white sand micro-blasted composite stone. Work wall-mounted hood in scotch brite steel and glass. Wall units with moka anodized doors PR21 and fumé reflecting glass. Tall units with cenere oak doors. Below: close-up of personalized scotch brite steel built-in hob with five burners Poliform by KitchenAid.

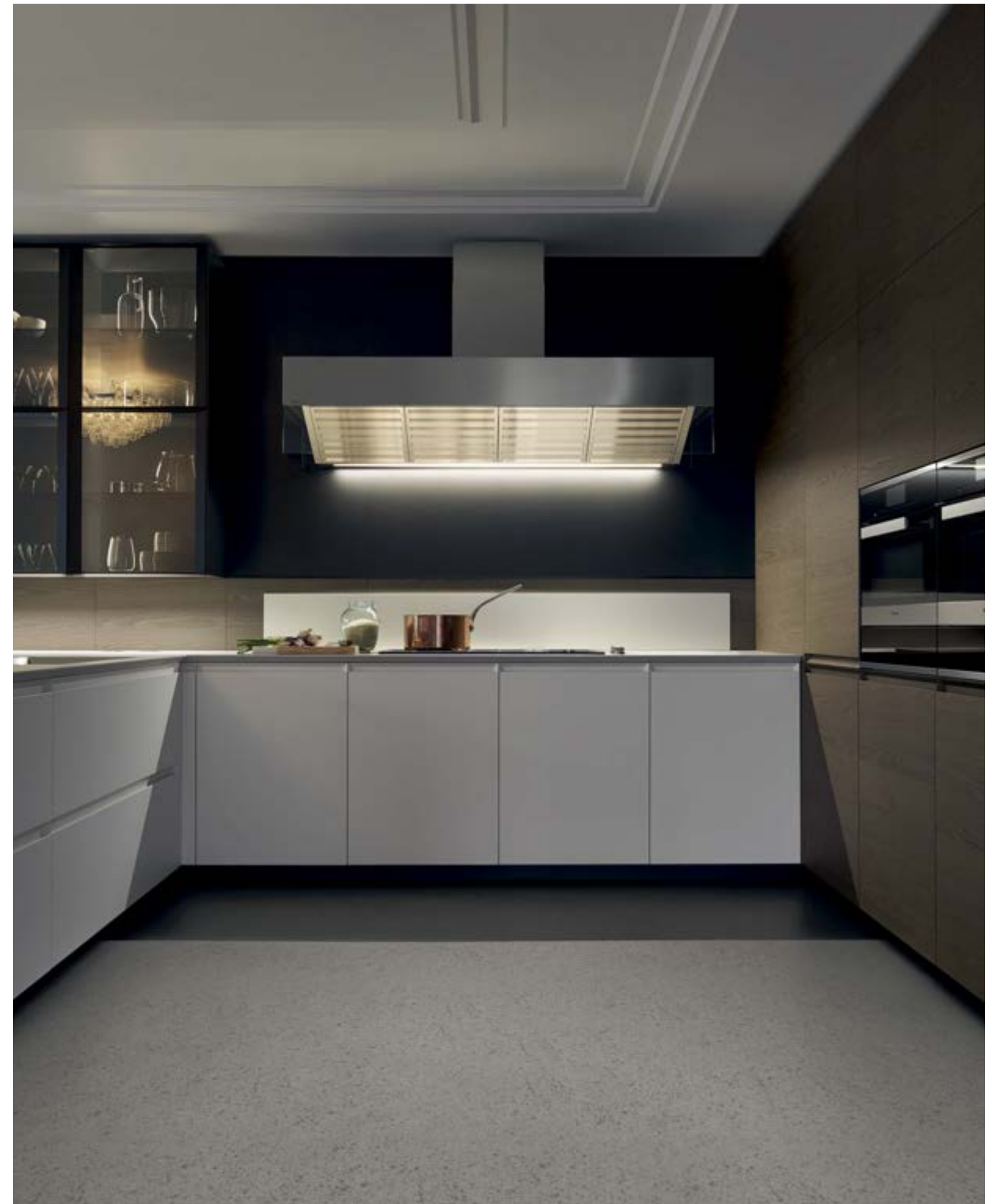

A destra: dettaglio della maniglia integrata Trail in laccato gofrato bianco. Top in quarzite white sand micropallinata con smusso a 45°.

To the right: close-up of bianco embossed lacquered Trail integrated handle. Top in white sand micro-blasted composite stone with 45° chamfered edge.





A sinistra: dettaglio della particolare lavorazione che caratterizza la maniglia del modello Trail. Estrattore con cassetto interno verniciato brown e attrezzatura in alluminio. Sotto: top in quarzite white sand micro-pallinata con lavello integrato in acciaio scotch brite personalizzato Poliform by Barazza.

To the left: close-up of the workmanship that sets the Trail handle apart. Pull-out storage baskets with inner drawer painted brown and equipment in aluminium. Below: top in white sand micro-blasted composite stone with personalized built-in scotch brite steel sink Poliform by Barazza.





Nelle pagine precedenti: basi con ante ed estrattori in laccato gofrato bianco e top in quarzite white sand micropallinata. In appoggio sulle basi, piano snack in rovere cenere. Sgabelli lcs in rovere spessart. Colonne con ante rovere cenere. A destra: dettaglio dell'elemento a giorno Trail in rovere cenere. Sotto: colonne con ante battenti, estrattori ed elementi a giorno in rovere cenere con ripiani in lamiera verniciata carbone retroilluminati.

Previous pages: base units with bianco embossed lacquered doors and pull-out storage baskets, top in white sand micro-blasted composite stone. Snack top in cenere oak. lcs stools in spessart oak. Tall units with cenere oak doors. To the right: close-up of open element Trail in cenere oak. Below: tall units with leaf doors, pull-out storage baskets and open elements in cenere oak with backlit shelves in carbone painted steel sheet.

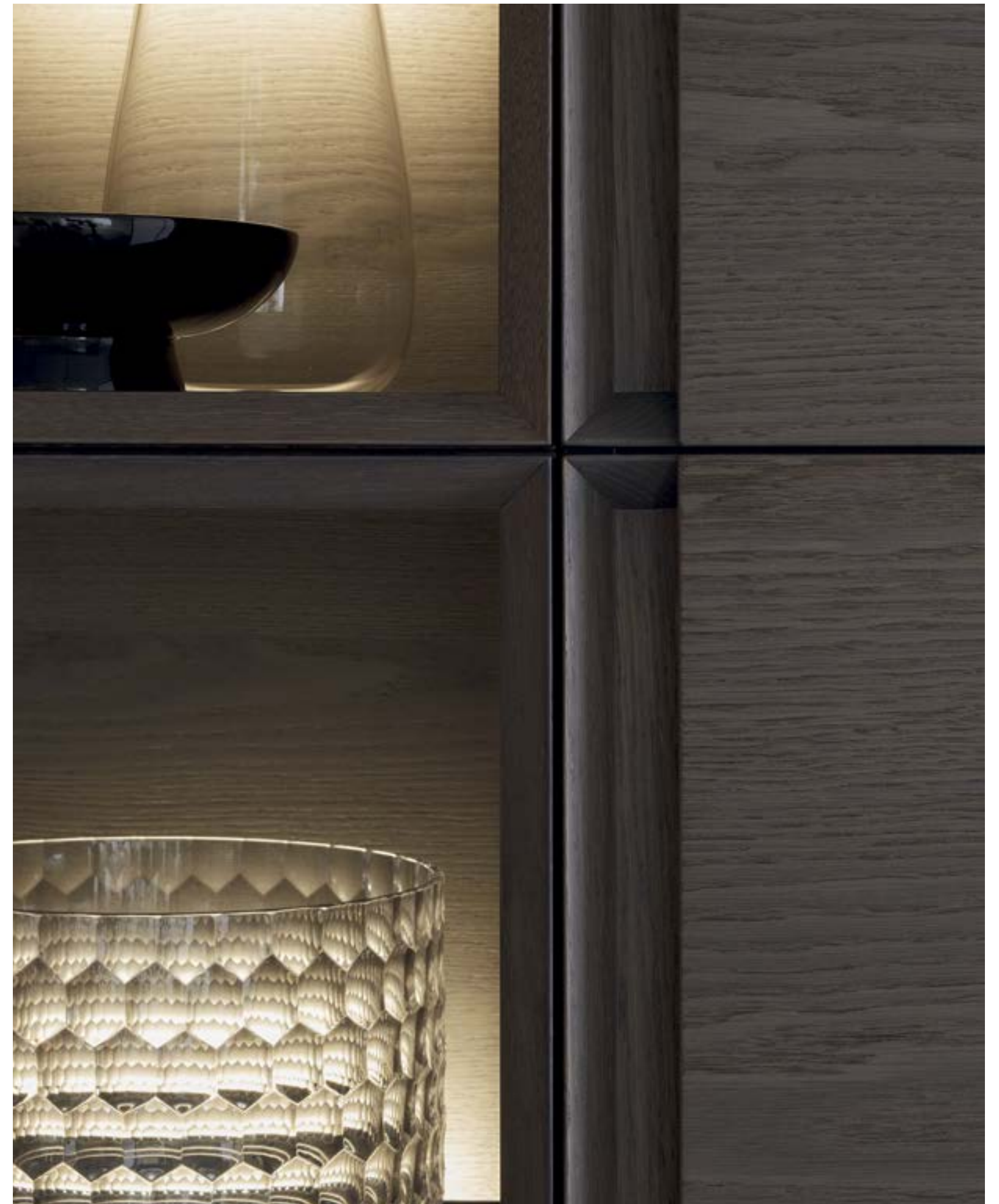



A sinistra: colonne con ante rovere cenere. Boiserie a muro in laccato goffrato bianco e mensole in acciaio scotch brite.

To the left: tall units with cenere oak doors. Bianco embossed lacquered wall panelling and shelves in scotch brite steel.





A sinistra e nelle pagine precedenti: colonne ed elementi sopra colonna in rovere cenere, ante della cantina vini e del frigo con congelatore in acciaio scotch brite e maniglie Grip acciaio godronato. Cantina vini con ripiani in legno. Boiserie in laccato goffrato bianco e mensole in acciaio scotch brite. Sgabello lcs in rovere spessart. Sotto: dettaglio della boiserie in laccato goffrato bianco e mensole in acciaio scotch brite.

To the left and previous pages: tall units and cabinets over tall unit in cenere oak, doors in scotch brite steel and Grip handles in knurled steel. Wine cooler with wood shelves. Bianco embossed lacquered wall panelling and shelves in scotch brite steel. lcs stool in spessart oak. Below: close up of bianco embossed lacquered wall panelling and shelves in scotch brite steel.



TRAIL

Design Carlo Colombo and R&D Poliform

Basi p 740 / 1280

Strutture: nobilitato grigio lavagna.
Ante ed estrattori: laccato goffrato bianco.
Maniglie: integrata Trail.
Fianchi e top: quarzite white sand micropallinata con smusso a 45°, spessore 30 mm.
Schienali: quarzite white sand micropallinata.
Zoccoli: laccato goffrato moka.

Snack I 1800

Piano: rovere cenere.

Pensili vetrina PR21 p 410

Strutture: nobilitato grigio lavagna.
Ante: anodizzato moka e vetro riflettente fumé.
Aperture: battente con profilo luminoso e tip-on.
Ripiani interni: vetro fumé.

Colonne p 640

Strutture: nobilitato grigio lavagna.
Ante: rovere cenere.
Maniglie: integrata Trail.
Zoccoli: laccato goffrato moka.

Elementi sopra colonna p 640

Strutture: nobilitato grigio lavagna.
Ante: rovere cenere.
Maniglie: integrata Trail.

Complementi

Sgabelli Ics: rovere spessart.

Base units d 29 1/4" / 50 1/2"

Structures: grey lavagna melamine.
Doors and pull-out storage baskets: embossed lacquered bianco.
Handles: Trail integrated.
Side panels and top: white sand micro-blasted composite stone with 45° chamfered edge, thickness 1/4".
Back panels: white sand micro-blasted composite stone.
Plinths: embossed lacquered moka.

Snack w 70 3/4"

Top: cenere oak.

Glass wall units PR21 d 16 1/4"

Structures: grey lavagna melamine.
Doors: anodized moka and fumé reflecting glass.
Openings: leaf door with lighted profile and tip-on opening.
Inner shelves: fumé glass.

Tall units d 25 1/4"

Structures: grey lavagna melamine.
Doors: cenere oak.
Handles: Trail integrated.
Plinths: embossed lacquered moka.

Cabinets above tall unit d 25 1/4"

Structures: grey lavagna melamine.
Doors: cenere oak.
Handles: Trail integrated.

Accessories

Ics stool: spessart oak.

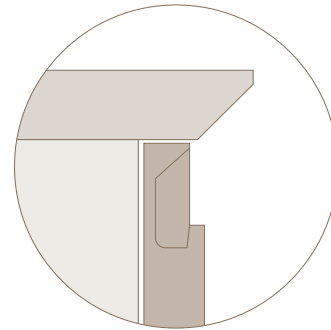

Basi e pensili vetrina Base units and glass wall units

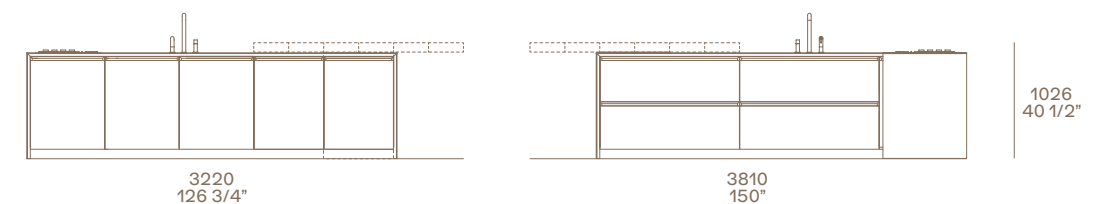
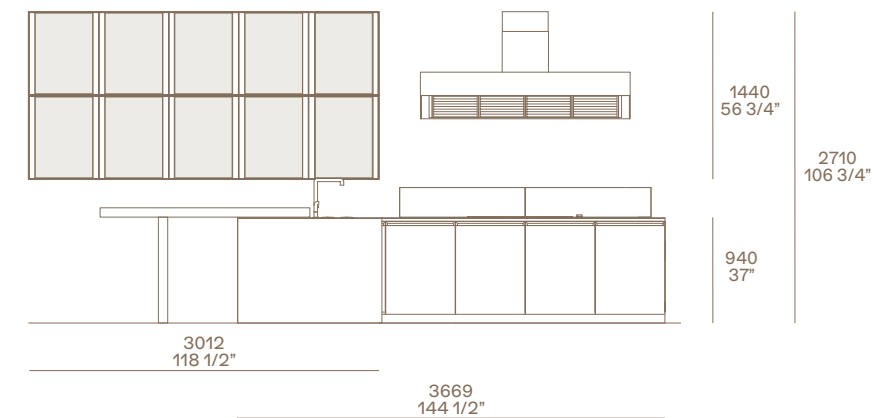

Colonne Tall units

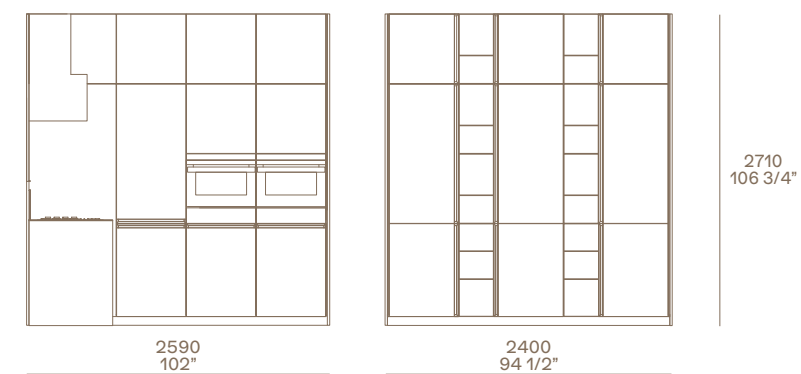

Ics Design Rodrigo Torres

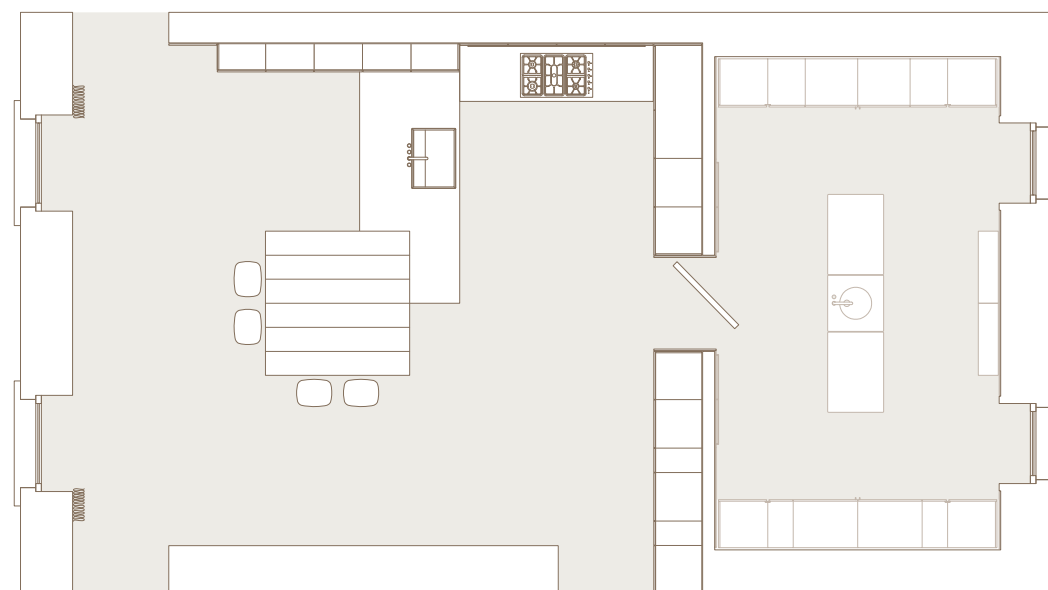
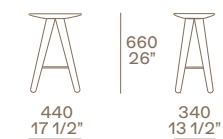

Trail

Alea

- 1 Lavello acciaio scotch brite personalizzato Poliform by Barazza, incasso filotop.
- 2 Piano cottura in acciaio scotch brite 5 fuochi personalizzato Poliform by KitchenAid, incasso filotop.

- 3 Cappa Work a parete in acciaio scotch brite e vetro.
- 4 Piano snack isola quadrato 1800 x 1800.
- 5 Attrezzatura in alluminio per cassetti interni ed estrattori.
- 6 Pensili vetrina PR21 con ante battenti, apertura con profilo e tip-on.

- 7 Colonne con forno e scaldavivande.
- 8 Colonna frigo con ante battenti, estrattori ed elementi a giorno.

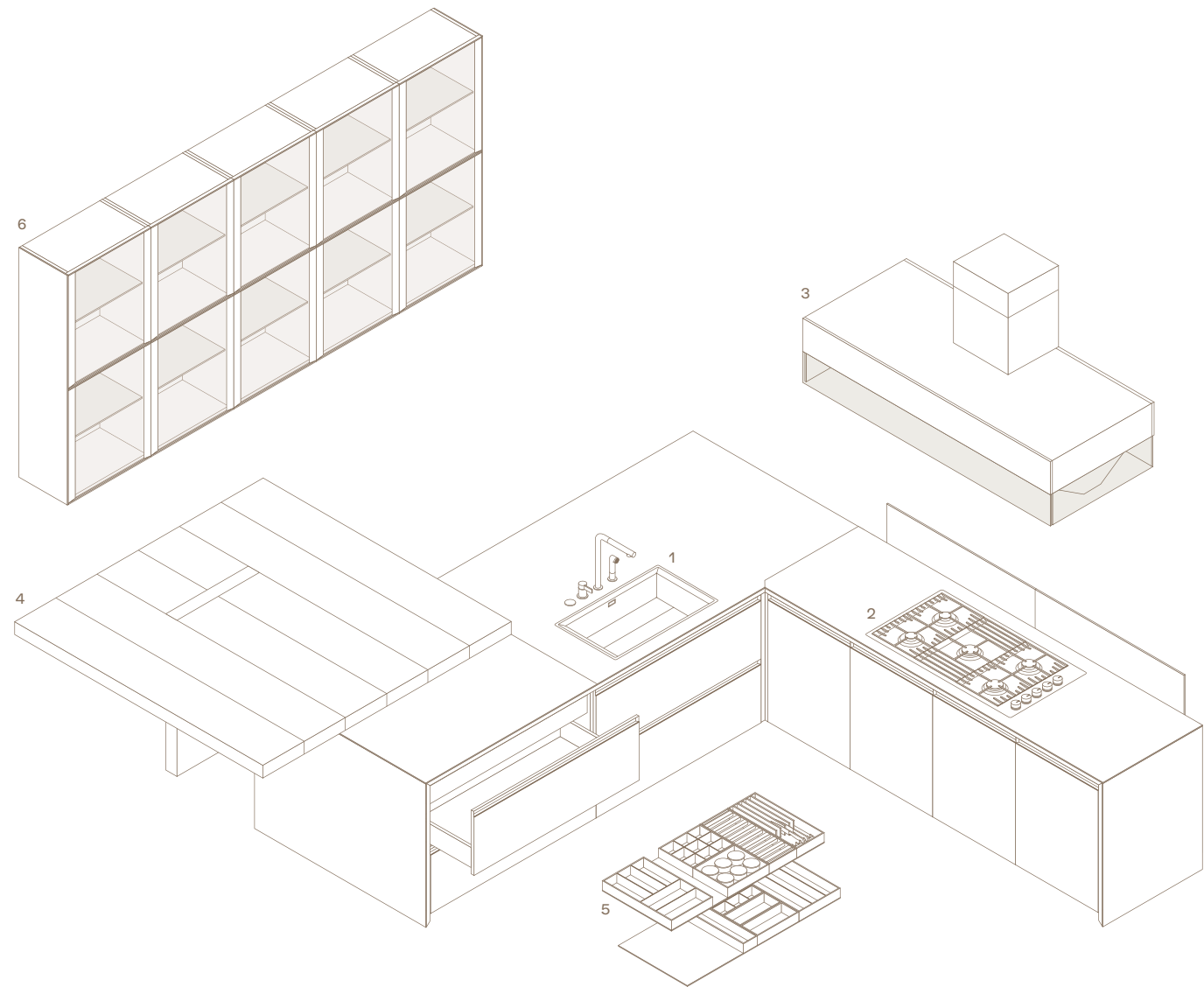

- 1 Personalized scotch brite steel sink Poliform by Barazza, flush built-in.
- 2 Poliform personalized scotch brite steel hob with 5 burners by KitchenAid, flush built-in.
- 3 Work wall-mounted hood in scotch brite steel and glass.

- 4 Square island snack top 70 3/4" x 70 3/4".
- 5 Equipment in aluminium for inner drawers and pull-out storage baskets.
- 6 Glass wall units PR21 with leaf doors, opening with profile and tip-on.

- 7 Tall units with oven and plate warmer.
- 8 Fridge tall unit with leaf doors, pull-out storage baskets and open elements.

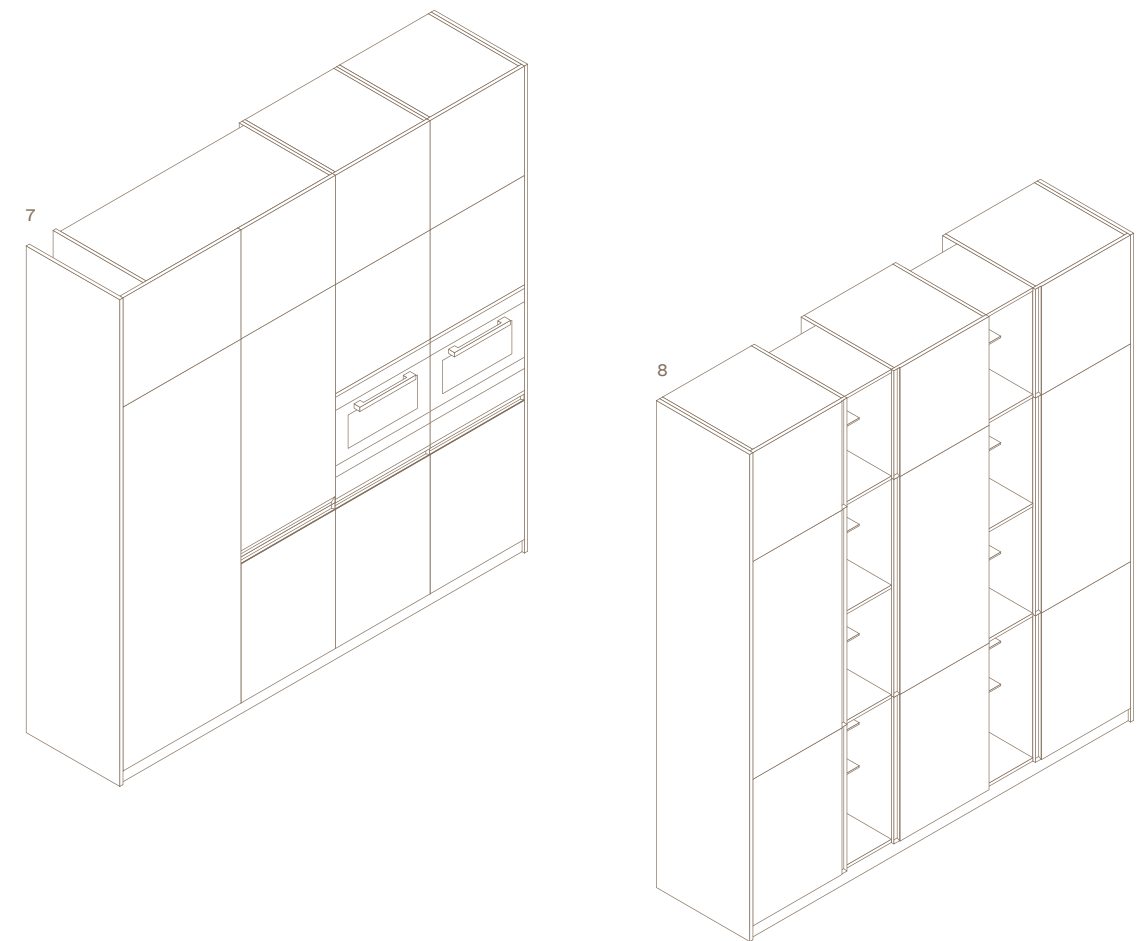

ALEA

Design R&D Poliform

Colonne p 640

Strutture: nobilitato grigio lavagna.
 Ante: rovere cenere.
 Fianchi: rovere cenere, spessore 6 mm.
 Ante per cantina vini e frigo/congelatore:
 acciaio scotch brite.
 Maniglie per cantina vini e frigo/congelatore:
 Grip, acciaio godronato.
 Distanziatori verticali: rovere cenere.
 Zoccoli: laccato goffrato moka.

Elementi sopracolonna p 640

Strutture: nobilitato grigio lavagna.
 Ante: rovere cenere.
 Maniglie incassate su bordo anta: laccato
 goffrato moka.
 Distanziatori verticali: rovere cenere.

Boiserie

Pannelli: laccato goffrato bianco.
 Mensole: acciaio scotch brite,
 spessore 3 mm.

Complementi

Sgabello lcs: rovere spessart.

Tall units d 25 1/4"

Structures: grey lavagna melamine.
 Doors: cenere oak.
 Side panels: cenere oak, thickness 1/4".
 Doors for wine cooler and
 fridge/freezer: scotch brite steel.
 Handles for wine cooler and
 fridge/freezer: Grip, knurled steel.
 Vertical spacers: cenere oak
 Plinths: embossed lacquered moka.

Cabinets above tall unit d 25 1/4"

Structures: grey lavagna melamine.
 Doors: cenere oak.
 Handles built-in in the door edge:
 embossed lacquered moka.
 Vertical spacers: cenere oak.

Wall panelling

Panels: embossed lacquered bianco.
 Shelves: scotch brite steel,
 thickness 1/8".

Accessories

lcs stool: spessart oak.

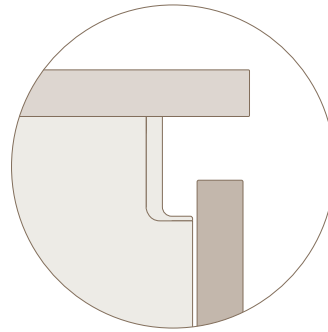

Boiserie Wall panelling

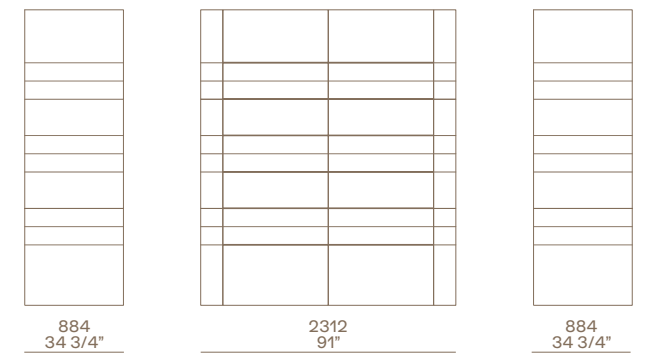
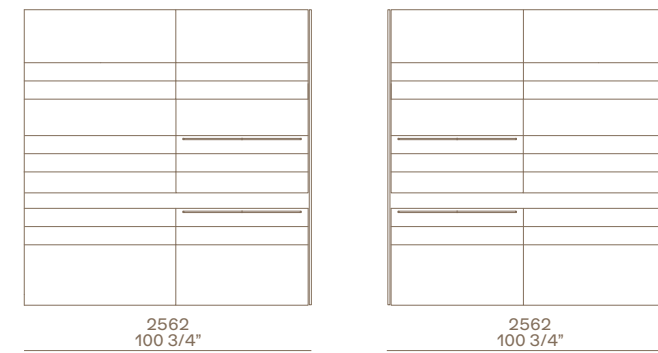

Colonne Tall units

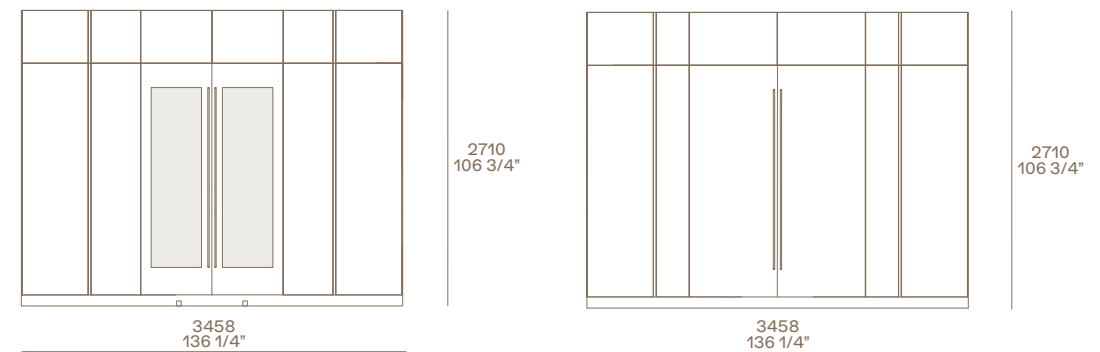

Isola Island

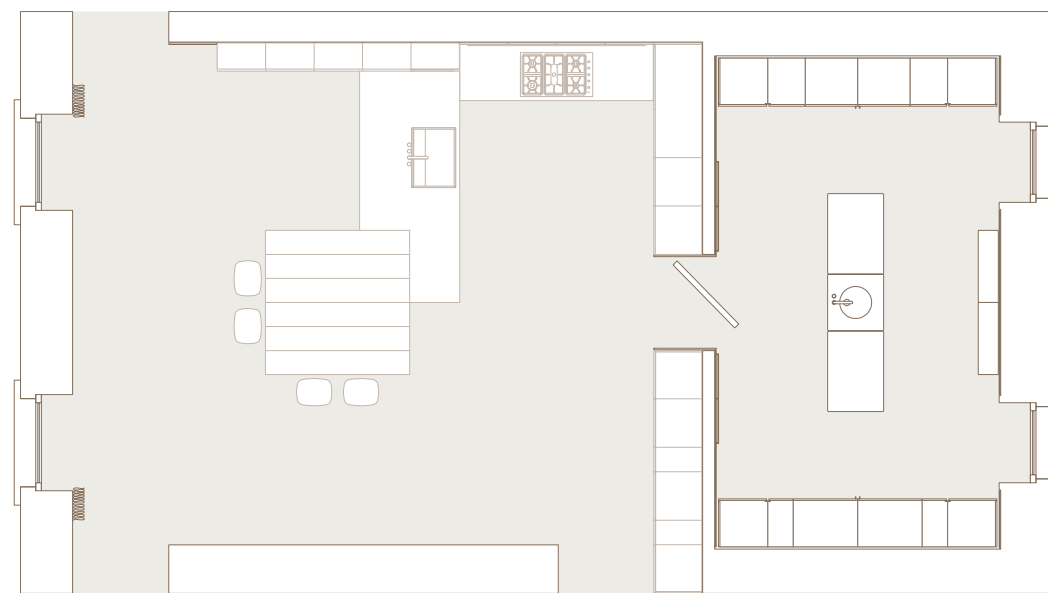
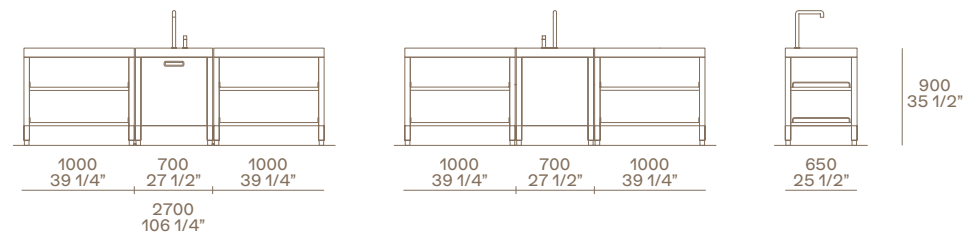

Trail

Alea

TECHNICAL DATA

CARATTERISTICHE DEI MODELLI CHARACTERISTICS OF THE MODELS	310
VETRINE SHOWCASES	320
ATTREZZATURA CASSETTI DRAWERS EQUIPMENTS	322
ATTREZZATURA ESTRATTORI PULL-OUT BASKETS EQUIPMENTS	323
COLONNE ATTREZZATE EQUIPPED TALL UNITS	324
VANI ATTREZZATI EQUIPPED UNITS	325
COLONNE CON VANI A GIORNO OPEN TALL UNITS	326
DEEP SHAKER E SHAKER SCHIENALI MODULARI DEEP SHAKER AND SHAKER MODULAR BACKS	327
SOLUZIONI PER ANGOLI CORNER SOLUTIONS	328
COLONNE HIGH HIGH TALL UNITS	329
PIANI COTTURA HOBS	330
LAVELLI SINKS	331
CAPPE HOODS	332
PORTARIFIUTI WASTEBINS	334
SOLUZIONI DI ILLUMINAZIONE LIGHTING SOLUTIONS	335
PIANI SNACK SNACK TABLES	336
TAVOLI TABLES	338
SEDIE CHAIRS	340
SGABELLI STOOLS	342
PANCHE STOOLS	343
FINITURE FINISHINGS	344

SHAPE

Design R&D Poliform

Spessore anta

26 mm.
Maniglia integrata centrale 180 mm,
360 mm.

Finiture anta

Laccato lucido 18 colori.
Laccato goffrato 23 colori.
Laccato metallico 4 colori.
7 essenze.
Massello noce canaletto.
Massello rovere termico.
Massello rovere fossile.
Massello black ash.
Acciaio scotch brite.

Finiture maniglia

Laccato metallico bronzo.
Laccato opaco moka.

Door thickness

26 mm - 1".
Central built-in handle 180 mm - 7",
360 mm - 14 1/4".

Door finishings

Glossy lacquered 18 colours.
Embossed lacquered 23 colours.
Metallic lacquered 4 colours.
7 woods.
Solid walnut canaletto.
Solid thermic oak.
Solid fossil oak.
Solid black ash.
Steel scotch brite.

Handle finishings

Bronzo metallic lacquered.
Moka mat lacquered.

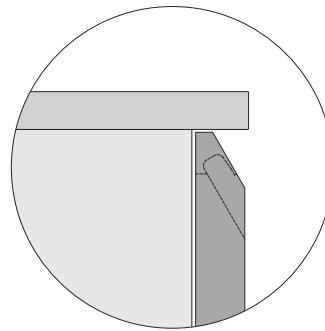

Spessore anta

26 mm.
Maniglia integrata laterale 180 mm.

Door thickness

26 mm - 1".
Lateral built-in handle 180 mm - 7".

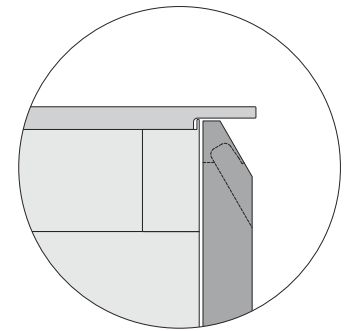

TRAIL

Design Carlo Colombo and R&D Poliform

Spessore anta

26 mm.
Maniglia integrata.

Finiture anta

Laccato lucido 18 colori.
Laccato goffrato 23 colori.
Laccato metallico 4 colori.
5 essenze.

Door thickness

26 mm - 1".
Built-in handle.

Door finishings

Glossy lacquered 18 colours.
Embossed lacquered 23 colours.
Metallic lacquered 4 colours.
5 woods.

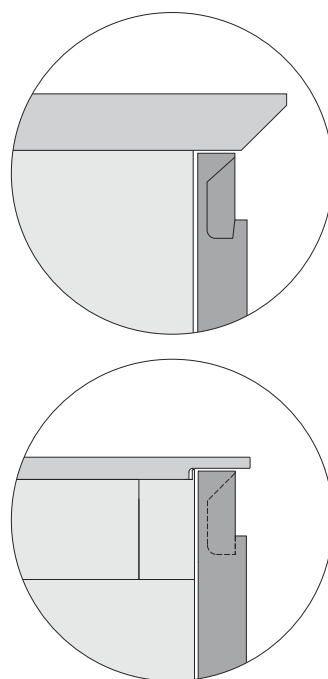

PHOENIX

Design R&D Poliform

Spessore anta

26 mm.
Maniglia integrata.

Finiture anta

Laccato lucido 18 colori.
Laccato goffrato 23 colori.
Laccato metallico 4 colori.
5 essenze.
Massello noce canaletto.
Massello rovere termico.
Massello rovere fossile.
Massello black ash.
DuPont Corian® glacier white.
Acciaio scotch brite.

Door thickness

26 mm - 1".
Built-in handle.

Door finishings

Glossy lacquered 18 colours.
Embossed lacquered 23 colours.
Metallic lacquered 4 colours.
5 woods.
Solid walnut canaletto.
Solid thermic oak.
Solid fossil oak.
Solid black ash.
DuPont Corian® glacier white.
Steel scotch brite.

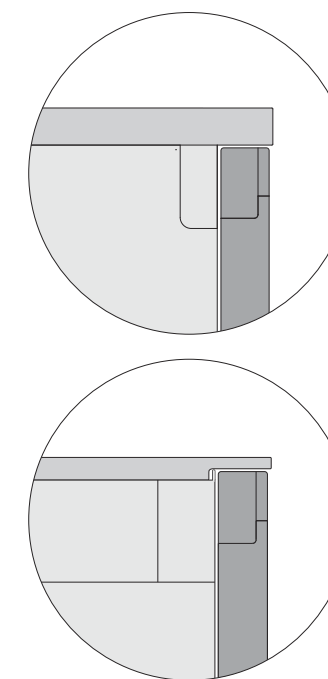

ARTEX
Design R&D Poliform

Anta a doghe
Spessore anta
26 mm.
Lato maniglia sagomato 60°.

Finiture anta
Laccato goffrato 23 colori.
7 essenze.
DuPont Corian® glacier white.

Door with carved lines
Door thickness
26 mm - 1".
Handle edge shaped to 60°.

Door finishings
Embossed lacquered 23 colours.
7 woods.
DuPont Corian® glacier white.

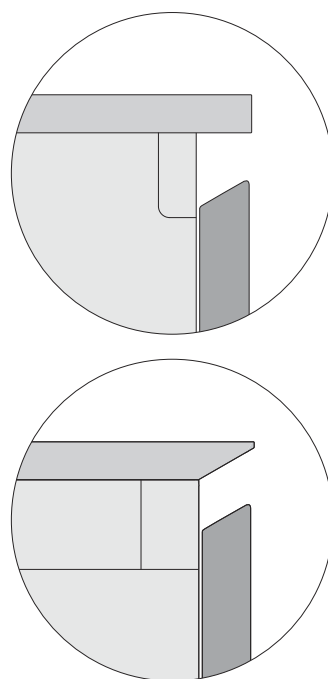

Anta liscia
Spessore anta
26 mm.
Lato maniglia sagomato 60°.

Finiture anta
Laminato opaco touch 6 colori.
Laminato opaco touch 6 colori.
Laccato lucido 18 colori.
Laccato goffrato 23 colori.
Laccato metallico 4 colori.
7 essenze.
Massello noce canaletto.
Massello rovere termico.
Massello rovere fossile.
Massello black ash.
DuPont Corian® glacier white.
Acciaio scotch brite.

Flat door
Door thickness
26 mm - 1".
Handle edge shaped to 60°.

Door finishings
Mat laminate 6 colours.
Mat laminate touch 6 colours.
Glossy lacquered 18 colours.
Embossed lacquered 23 colours.
Metallic lacquered 4 colours.
7 woods.
Solid walnut canaletto.
Solid thermic oak.
Solid fossil oak.
Solid black ash.
DuPont Corian® glacier white.
Steel scotch brite.

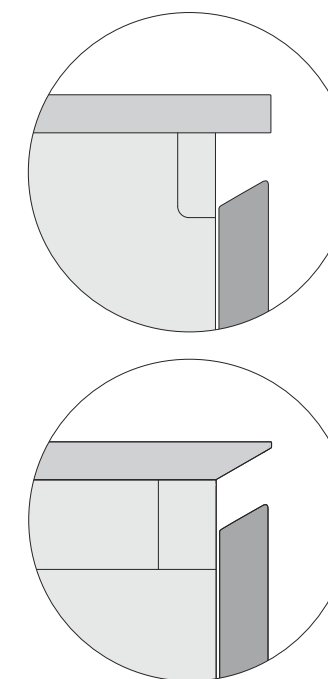

ALEA

Design R&D Poliform

Spessore anta
20 mm.

Finiture anta

Laminato opaco 6 colori.
Laminato opaco touch 6 colori.
Laccato lucido 18 colori.
Laccato goffrato 23 colori.
Laccato metallico 4 colori.
Nobilitato 7 finiture.
8 essenze.
Acciaio scotch brite.
Vetro satinato 6 colori.
Vetro lucido 6 colori.

Ante vetro con telaio di supporto
in alluminio anodizzato naturale
o anodizzato nero.

Door thickness
20 mm - 3/4".

Door finishings

Mat laminate 6 colours.
Mat laminate touch 6 colours.
Glossy lacquered 18 colours.
Embossed lacquered 23 colours.
Metallic lacquered 4 colours.
Melamine 7 finishings.
8 woods.
Steel scotch brite.
Etched glass 6 colours.
Glossy glass 6 colours.

Glass doors with supporting frame
in natural anodized or black anodized
aluminium.

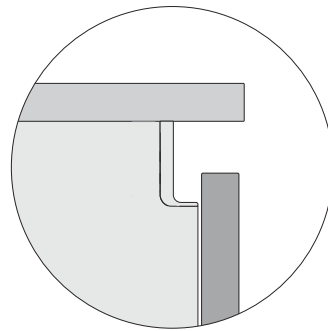

TWELVE

Design Carlo Colombo and R&D Poliform

Spessore anta
12 mm.

Finiture anta

Laminato opaco 6 colori.
Laminato opaco touch 6 colori.
Laccato lucido 18 colori.
Laccato goffrato 23 colori.
Laccato metallico 4 colori.
7 essenze.
Acciaio scotch brite.
Vetro satinato 6 colori.
Vetro lucido 6 colori.

Ante vetro con telaio di supporto
in alluminio anodizzato naturale
o anodizzato nero.

Door thickness
12 mm - 1/2".

Door finishings

Mat laminate 6 colours.
Mat laminate touch 6 colours.
Glossy lacquered 18 colours.
Embossed lacquered 23 colours.
Metallic lacquered 4 colours.
7 woods.
Steel scotch brite.
Etched glass 6 colours.
Glossy glass 6 colours.

Glass doors with supporting frame
in natural anodized or black anodized
aluminium.

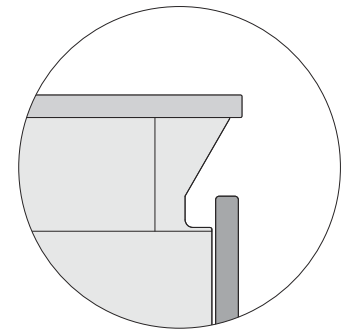

MY PLANET
Design R&D Poliform

Anta con maniglia integrata
Spessore anta
20 mm.

Finiture anta
Laminato opaco 6 colori.
Laminato opaco touch 6 colori.
Laccato lucido 18 colori.
Laccato goffrato 23 colori.
Laccato metallico 4 colori.
Nobilitato 7 finiture.
8 essenze.

Finiture maniglia
Laccato goffrato 23 colori.
Laccato silk perla, bronzo, grey.
Laccato opaco alluminio, acciaio e titanio.

Door with built-in handle
Door thickness
20 mm - 3/4".

Door finishings
Mat laminate 6 colours.
Touch mat laminate 6 colours.
Glossy lacquered 18 colours.
Embossed lacquered 23 colours.
Metallic lacquered 4 colours.
Melamine 7 finishings.
8 woods.

Handle finishings
Embossed lacquered 23 colours.
Perla, bronzo, grey silk lacquered.
Aluminium, steel and titanio mat lacquered.

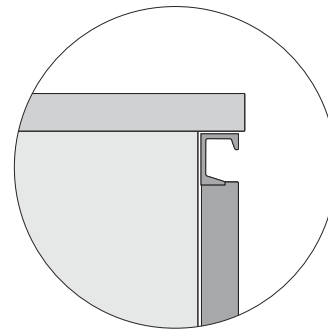

Anta con maniglia applicata
Spessore anta
20 mm.
5 modelli di maniglie.

Finiture anta
Laminato opaco 6 colori.
Laminato opaco touch 6 colori.
Laccato lucido 18 colori.
Laccato goffrato 23 colori.
Laccato metallico 4 colori.
Nobilitato 7 finiture.
8 essenze.
Acciaio scotch brite.

Door with applied handle
Door thickness
20 mm - 3/4".
5 handles available.

Door finishings
Mat laminate 6 colours.
Mat laminate touch 6 colours.
Glossy lacquered 18 colours.
Embossed lacquered 23 colours.
Metallic lacquered 4 colours.
Melamine 7 finishings.
8 woods.
Steel scotch brite .

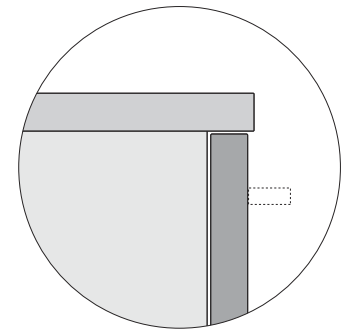

VETRINE SHOWCASES

PR19

Spessore 26 mm.
Anta in vetro riflettente 5051 bronzato
con telaio in alluminio verniciato bronzo.
Per pensili apertura con profilo inferiore
o apertura tip-on.
Thickness 26 mm - 1".
Door in bronzed reflecting glass 5051
with frame in bronzo painted aluminium.
For wall units with opening with lower
profile or tip-on opening.



PR22

Spessore 20 mm.
Anta in vetro riflettente 5059 fumé
con telaio alluminio anodizzato nero.
Per pensili apertura con profilo inferiore.
Per colonne apertura con distanziale
o con maniglia integrata verniciato nero.
Per elementi sopra colonna apertura
con distanziale o apertura tip-on.
Thickness 20 mm - 3/4".
Door in fumé reflecting glass 5059 with
black anodized aluminium frame.
For wall units with opening with lower profile.
For tall units with opening with spacer or
with black painted integrated handle.
For elements above tall unit with opening
with spacer or tip-on opening.



PR21

Spessore 26 mm.
Anta in vetro riflettente 5059 fumé
con telaio in alluminio anodizzato moka.
Per pensili apertura con profilo inferiore.
Per colonne apertura con maniglia
integrata verniciato moka.
Per elementi sopra colonna apertura tip-on.
Thickness 26 mm - 1".
Door in fumé reflecting glass 5059 with
moka anodized aluminium frame.
For wall units with opening with lower profile.
For tall units with opening moka painted
integrated handle.
For elements above tall unit with tip-on
opening.



ATTREZZATURA CASSETTI DRAWERS EQUIPMENTS

Tipologie

- 1 Cassetti.
- 2 Cassetti interni estraibile.
- 3 Cassetti interni anta.

Accessori

Portaposate, portacoltelli, bilancia elettronica, tagliere per pane, portaspezie in ceramica, vaschette in acciaio, set macinaspezie, portapelliole, portamattarello.

Types

- 1 Drawers.
- 2 Pull-out baskets.
- 3 Leaf door with inner drawers.

Accessories

Cutlery tray, knife-rack, electronic scale, chopping board for bread, ceramic spice-holder, steel basins, spice grinder set, protective-film rack, rolling pin-holder.

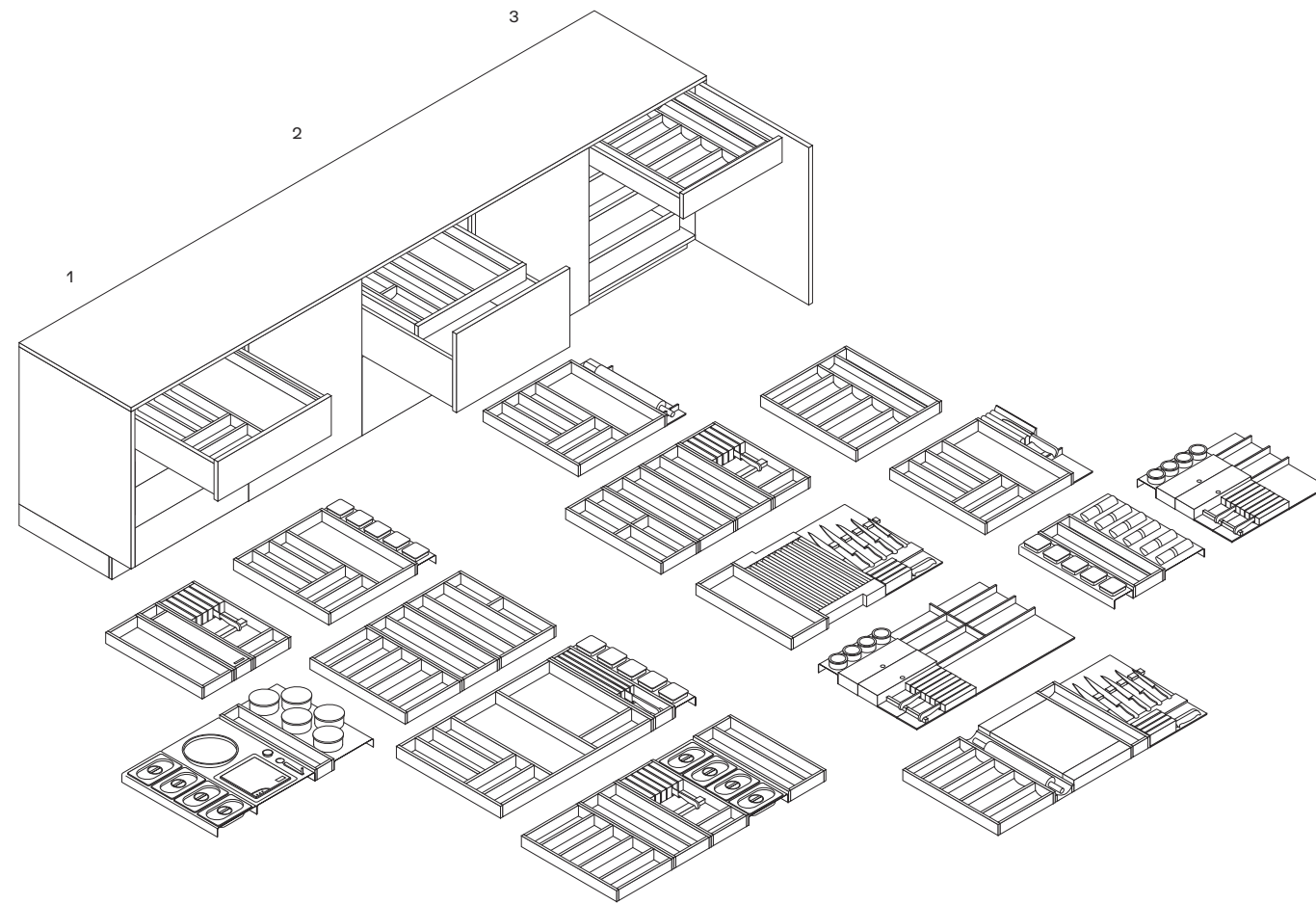

Attrezzature Equipments



Wengé
Wenge



Noce canaletto
Walnut canaletto



Laminato military touch
Laminate military touch



Alluminio
Aluminium



Materiale plastico
atossico antracite
Non-toxic plastic
colour antracite

ATTREZZATURA ESTRATTORI PULL-OUT BASKETS EQUIPMENTS

Tipologie

- 1 Base 1 estraibile e 2 cassetti.
- 2 Base 2 estraibili.
- 3 Base 1 estraibile unico e 1 estraibile interno.

Accessori

Piattaia, portapiatti regolabile, barattoli portapasta in acciaio, portapane in terracotta, portaspezie in ceramica, portarotolo, contenitori in ceramica, contenitori in acciaio.

Types

- 1 Base unit 1 pull-out basket and 2 drawers.
- 2 Base unit 2 pull-out baskets.
- 3 Base unit 1 pull-out basket and 1 inner pull-out basket.

Accessories

Plate-rack, adjustable plate-rack, kit pasta-holders in steel, clay bread container, ceramic spice-holder, rolling pin-holder, ceramic holders, steel holders.

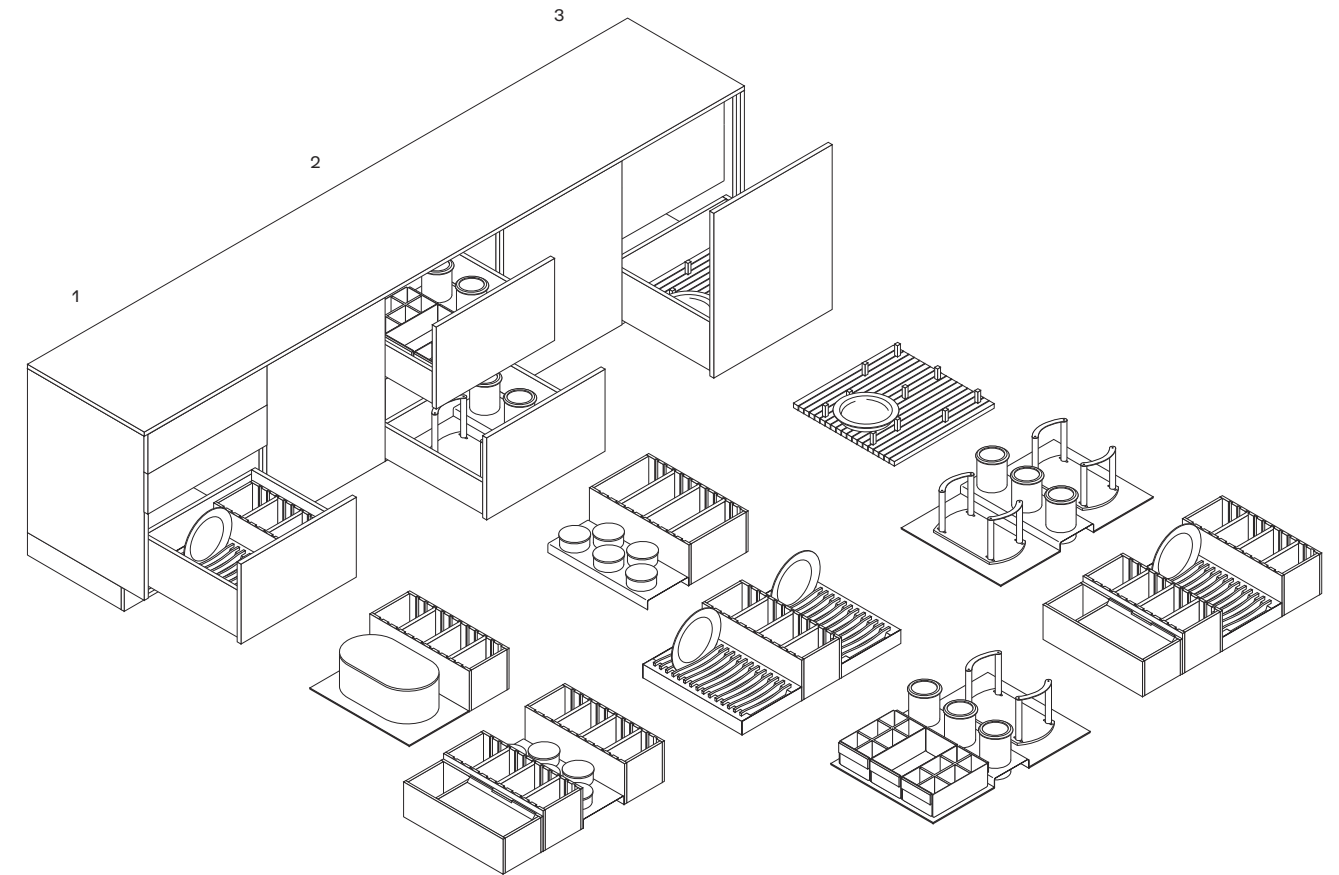

Attrezzature Equipments



Wengé
Wenge



Noce canaletto
Walnut canaletto



Laminato military touch
Laminate military touch

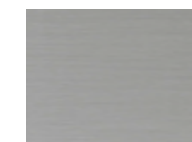

Alluminio
Aluminium

COLONNE ATTREZZATE EQUIPPED TALL UNITS

Tipologie

- 1 Colonna con struttura estraibile Tandem.
- 2 Colonna con struttura estraibile Convoy Lavido.
- 3 Colonna con struttura estraibile Convoy Centro.
- 4 Colonna attrezzata con ganci portascoppe e cestelli.

Types

- 1 Tall unit with Tandem extractable equipment.
- 2 Tall unit with Convoy Lavido extractable equipment.
- 3 Tall unit with Convoy Centro extractable equipment.
- 4 Tall unit with broom-holders and storage baskets.

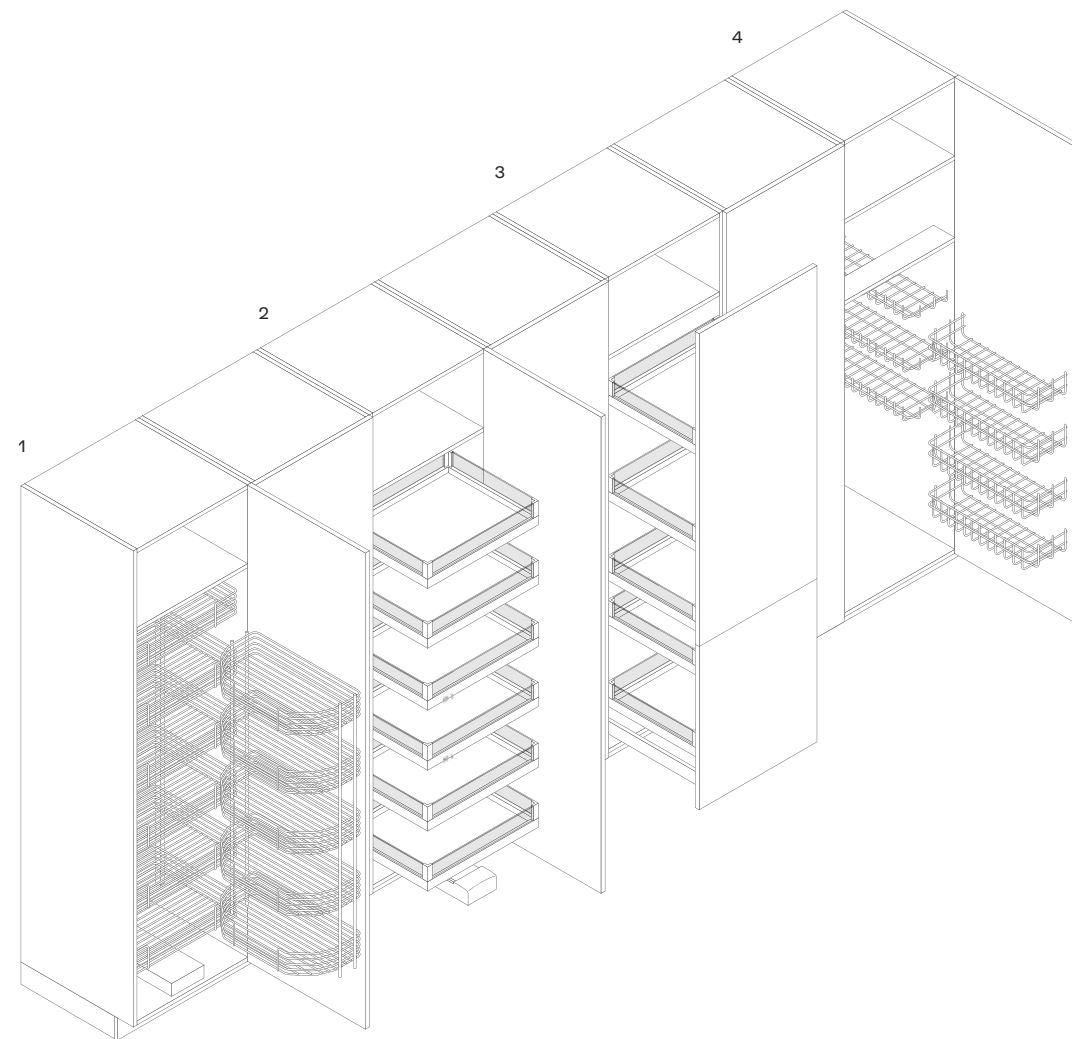

VANI ATTREZZATI EQUIPPED UNITS

Tipologie

- 1 Ante battenti apertura totale.
- 2 Ante a scomparsa.

Attrezzature

Piano di lavoro estraibile in acciaio o essenza, barra con lampade e presa elettrica, cassetti interni, ripiani, ripiani in vetro, Shaker e Deep Shaker, luce led.

Types

- 1 Total opening leaf door.
- 2 Pocket doors.

Equipments

Extractable worktop in steel or woods, light cover bar with lamp and socket, internal drawers, shelves, shelves in glass, Shaker and Deep Shaker, led lighting.

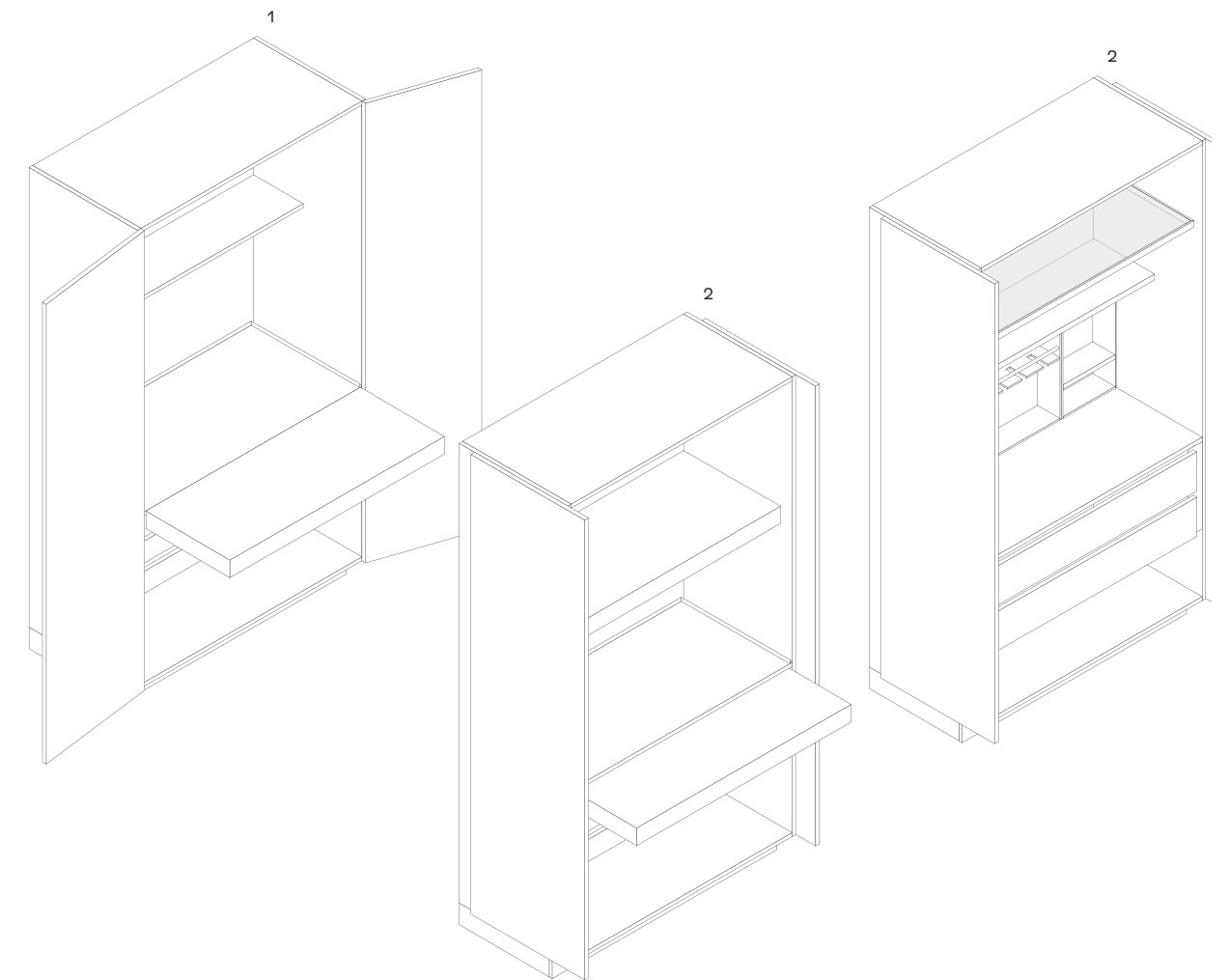

COLONNE CON VANI A GIORNO
OPEN TALL UNITS

Tipologie

- 1 Colonna a giorno con ripiani.
- 2 Colonna a giorno con cestelli in midollino.
- 3 Colonna a giorno Trail.

Types

- 1 Open tall unit with shelves.
- 2 Open tall unit with wicker baskets.
- 3 Trail open tall unit.

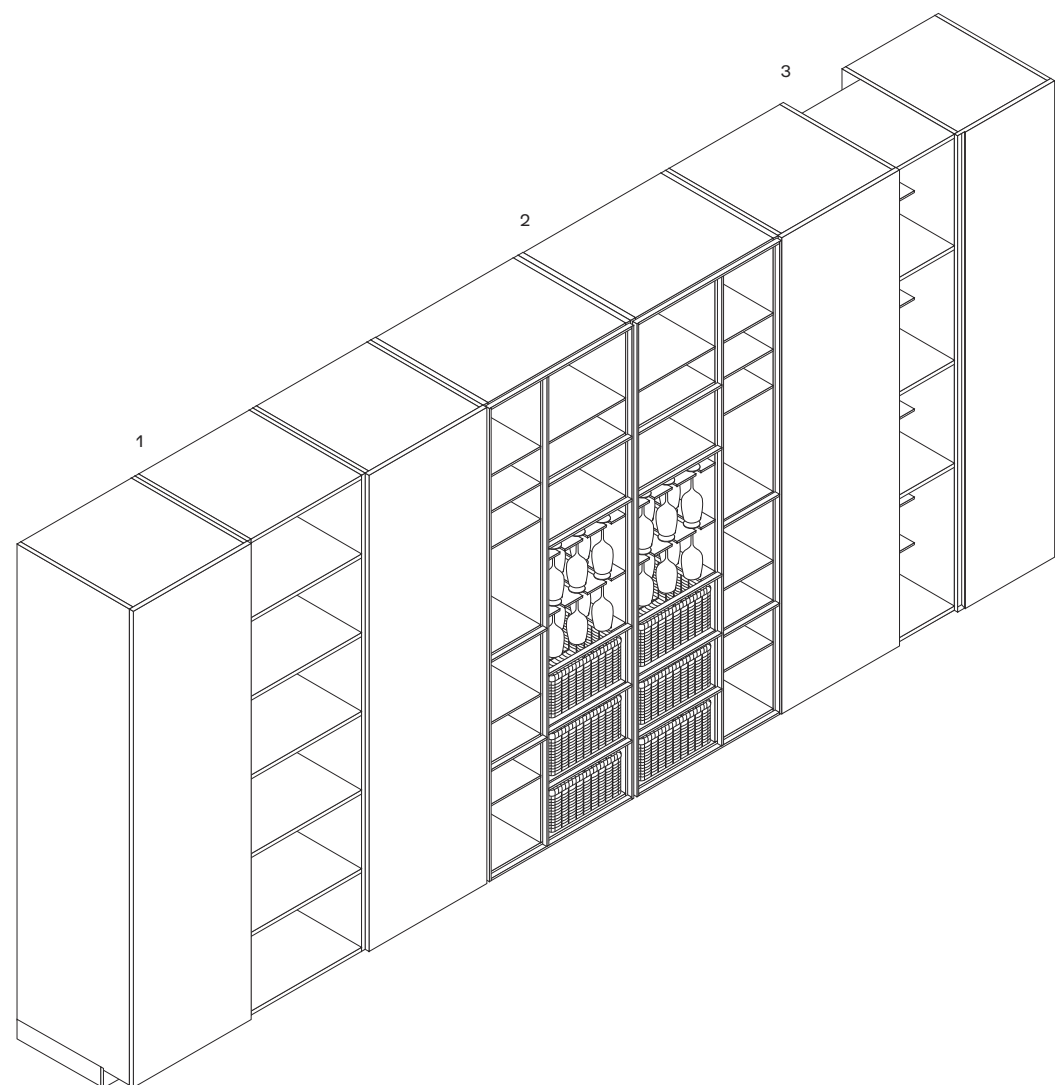

DEEP SHAKER E SHAKER SCHIENALI MODULARI
DEEP SHAKER AND SHAKER MODULAR BACKS

**Deep Shaker - profondità 160
Shaker - profondità 120**

Schienali modulari disponibili in diverse dimensioni e configurazioni. Moduli larghezza da 300 a 1200.

- 1 Moduli sopratop, misure variabili in riferimento allo spessore del top. Moduli Shaker h 600. Moduli Deep Shaker h 600-720-840.
- 2 Moduli a terra, Shaker e Deep Shaker h 1380-1440.

Deep Shaker attrezzature

Ripiani, tubi, contenitori in DuPont Corian®, porta spezie, porta coltelli, porta tablet, griglia, porta bicchieri, cassettoni in noce canalotto, barattoli in ceramica o in vetro, canalina elettrificata. Anta a ribalta con porta spezie, barattoli in ceramica o attrezzatura elettrica.

Shaker attrezzature

Ripiani, tubi, contenitori in DuPont Corian®, griglia, porta bicchieri.

**Deep Shaker - depth 6 1/4"
Shaker - depth 4 3/4"**

Modular backs available in different sizes and configurations. Modules width from 11 3/4" to 47 1/4".

- 1 Module above worktop, sizes according to the worktop thickness. Shaker modules h 23 1/2". Deep Shaker modules h 23 1/2"-28 1/4"-33".
- 2 Floorstanding modules, Shaker and Deep Shaker h 54 1/4"-56 3/4".

Deep Shaker accessories

Shelves, bars, containers in DuPont Corian®, spice holders, knife-rack, tablet holder, little drawers in walnut canaletto, ceramic or glass jars, powered conduit. Flap door with spices holder, ceramic jars or electric accessories.

Shaker accessories

Shelves, bars, containers in DuPont Corian®, grid, glass holders.

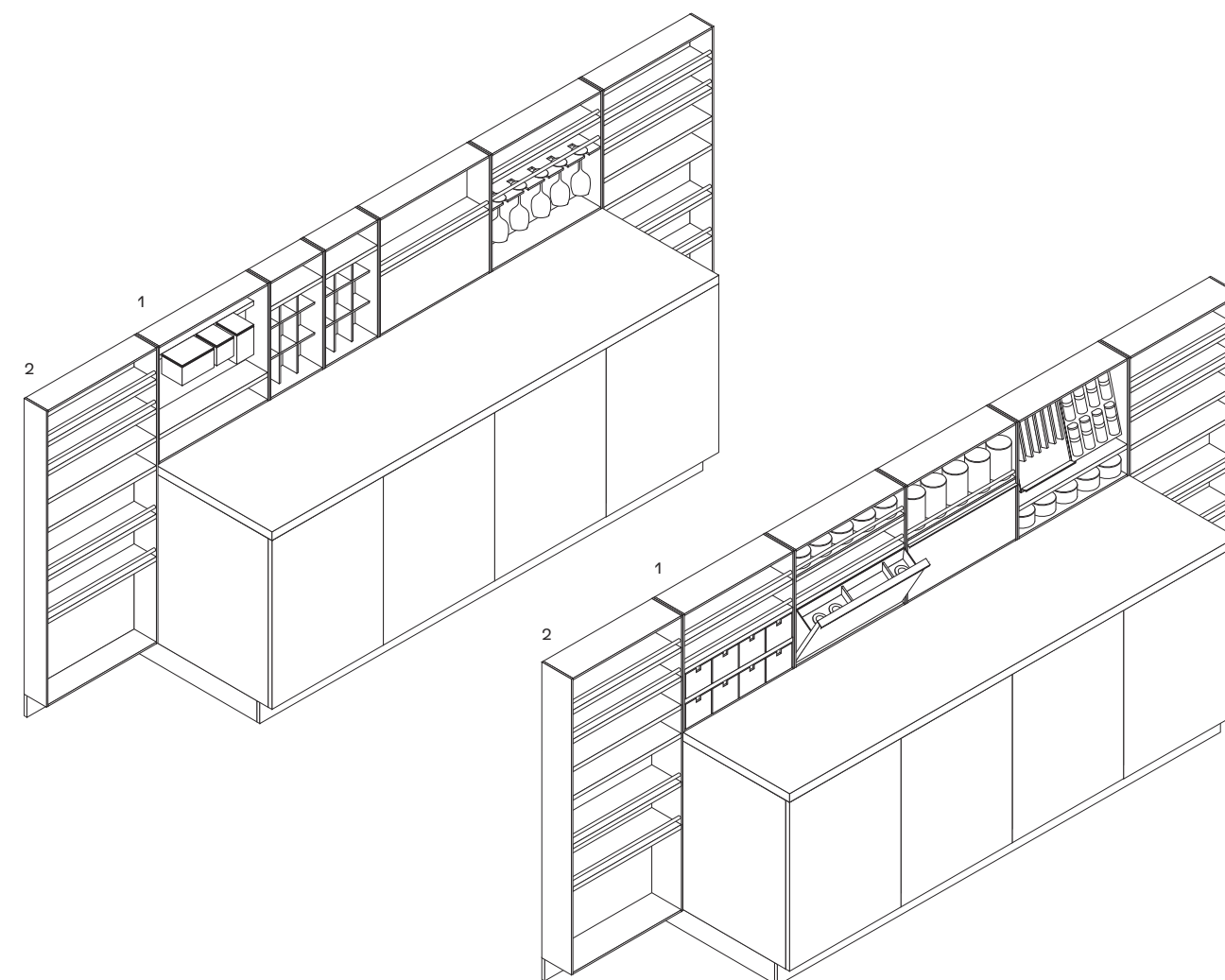

SOLUZIONI PER ANGOLI CORNER SOLUTIONS

Basi

- 1 Base doppio battente.
- 2 Base anta battente.

Pensili

- 3 Pensile anta battente.
- 4 Pensile anta pieghevole.
- 5 Pensile doppio battente.

Colonne

- 6 Colonna doppio battente.
- 7 Colonna anta battente.

Attrezzature

- 8 Cesti estraibili LeMans.
- 9 Cestelli in metallo cromato.

Base units

- 1 Base unit with two leaf doors.
- 2 Base unit with leaf door.

Wall units

- 3 Wall unit with leaf door.
- 4 Wall unit with folding door.
- 5 Wall unit with two leaf doors.

Tall units

- 6 Tall unit with two leaf doors.
- 7 Tall unit with leaf door and inner shelves.

Equipments

- 8 Pull-out storage baskets LeMans.
- 9 Baskets in chromed metal.

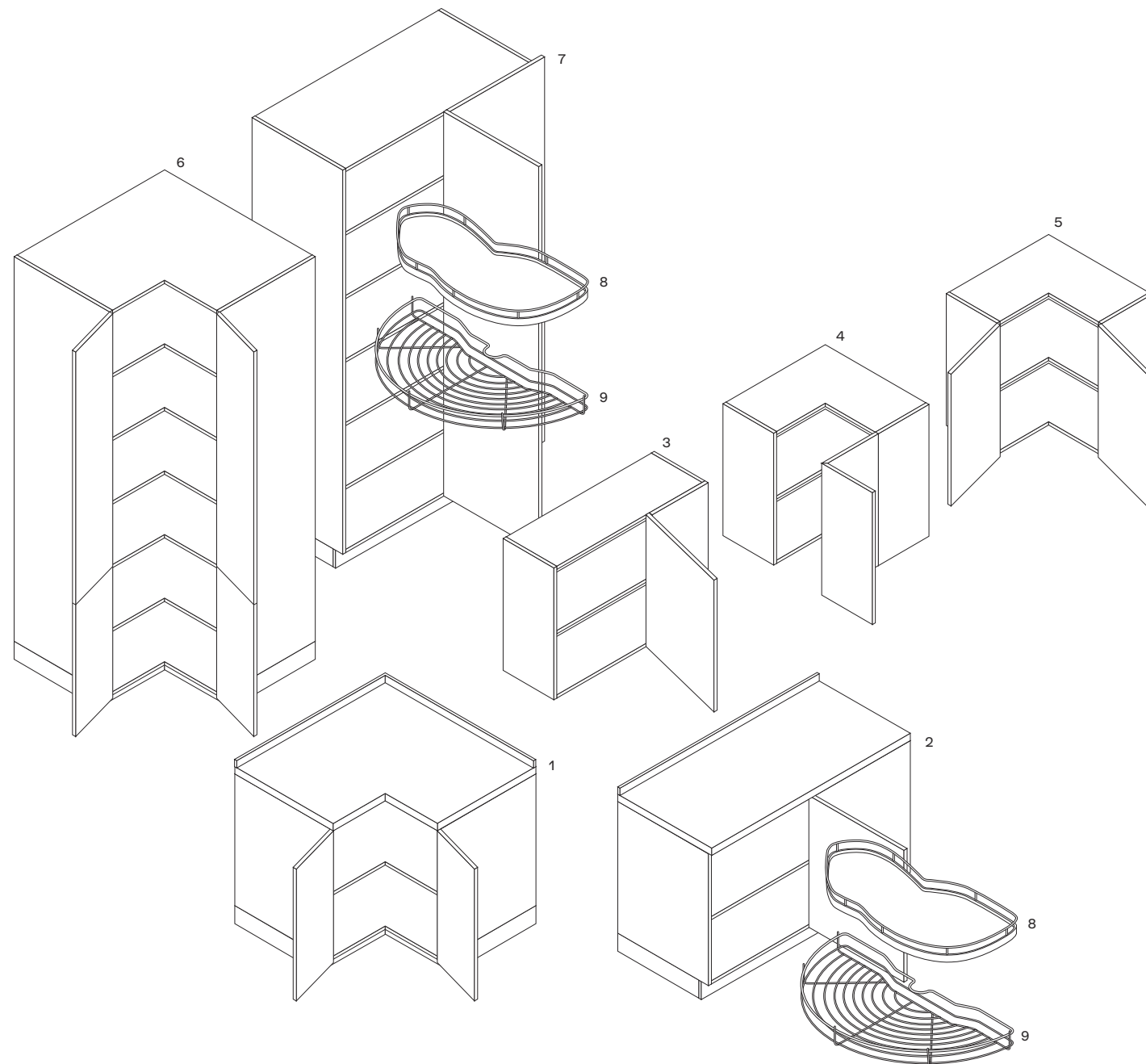

COLONNE HIGH HIGH TALL UNITS

Il sistema colonne High, disponibile per i modelli Shape, Artex, Phoenix e Trail, prevede la sovrapposizione di singoli fusti e il montaggio di un'anta intera o di due ante divise. Nel caso di ante divise, il taglio delle ante è situato sempre nella parte inferiore, a 840 mm dal filo inferiore della colonna. Lo zoccolo previsto è di 70 o 100 mm. Anta intera non disponibile nella versione in massello.

- 1 Colonna anta intera
h 2710-2740, anta h 2640
h 2830-2860, anta h 2760.
- 2 Colonna anta intera a scomparsa
h 2710-2740, anta h 2640.
- 3 Colonna con ante divise
h 2710-2740, ante h 840+1800
h 2830-2860, ante h 840+1920
h 2950-2980, ante h 840+2040.

The tall unit system High, available for the models Shape, Artex, Phoenix and trail, consists of two superimposed elements and a full height door or two separate doors. In case of separate doors, the separation of the doors is always in the lower part, 33" from the lower edge of the tall unit. The plinth is foreseen in h 3/4" or 4". The full height door is not available in solid wood finish.

- 1 Tall unit with full height door
h 106 3/4"-107 3/4", door h 104"
h 111 1/2"-112 1/2", door h 108 3/4".
- 2 Tall unit with full height pocket door
h 106 3/4"-107 3/4", door h 104".
- 3 Tall unit with separate doors
h 106 3/4"-107 3/4", doors h 33"+70 3/4"
h 111 1/2"-112 1/2", doors h 33"+75 1/2"
h 116 1/4"-117 1/4", doors h 33"+80 1/4".

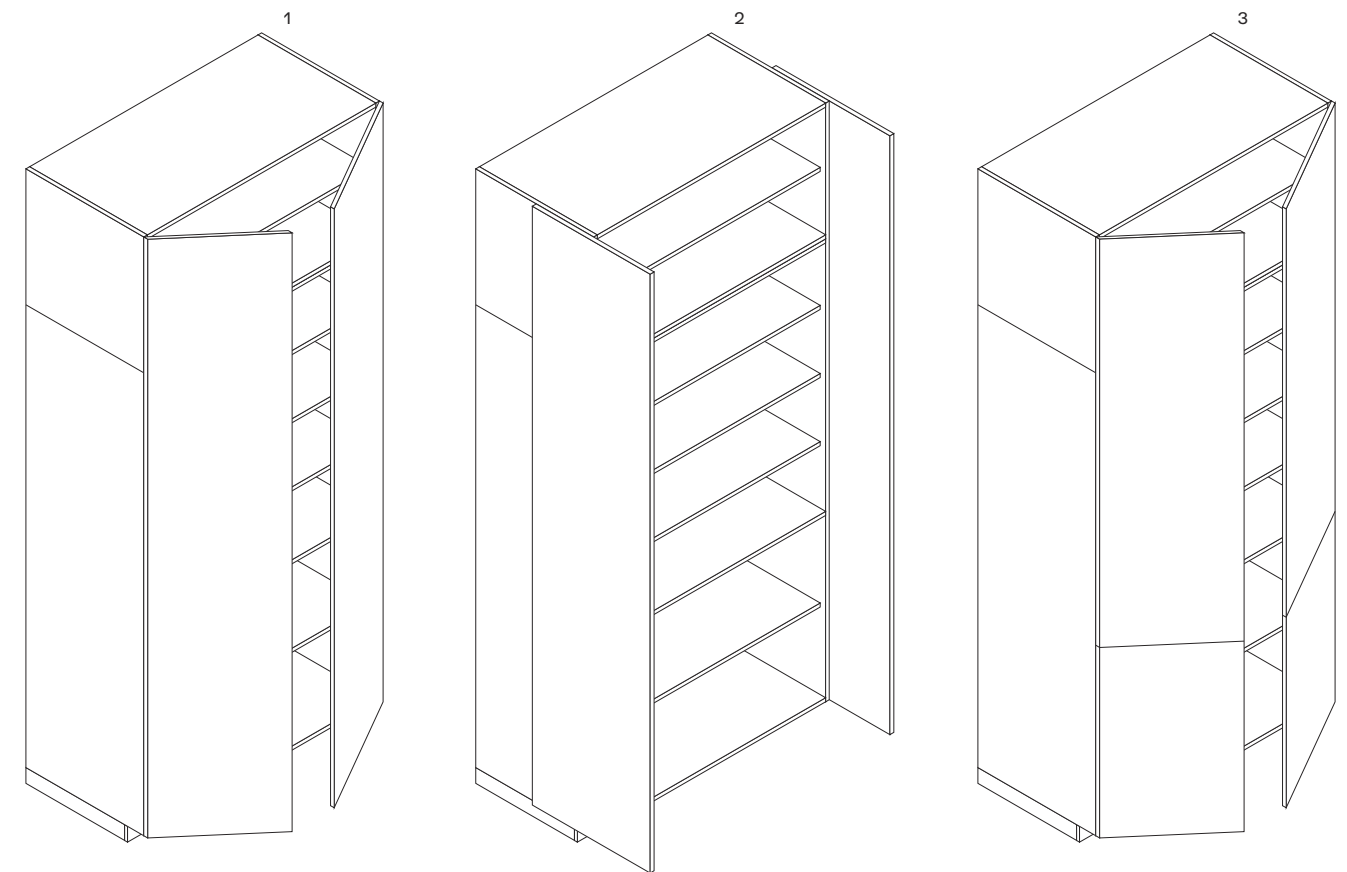

PIANI COTTURA HOBS

Tipologie

- 1 Piano a gas.
- 2 Piano a induzione.
- 3 Elementi modulari.

Tipologie di incasso

Incasso standard: il piano sporge da 4 a 15 mm; semifilotop: bordo inclinato di 3 mm; finotop: il piano sporge 1 mm; filotop. Nel caso di piani di lavoro in acciaio, i piani cottura possono essere saldati direttamente nella superficie del top.

Types

- 1 Gas hob.
- 2 Induction hob.
- 3 Modular elements.

Built-in types

Standard built-in with jutting hob of 1/4" a 1/2"; semi-flush built-in with inclined edge of 1/8"; flush built-in with jutting hob 5/128" and fully flush built-in. In case of steel worktops, the hobs can be soldered directly in the worktop.

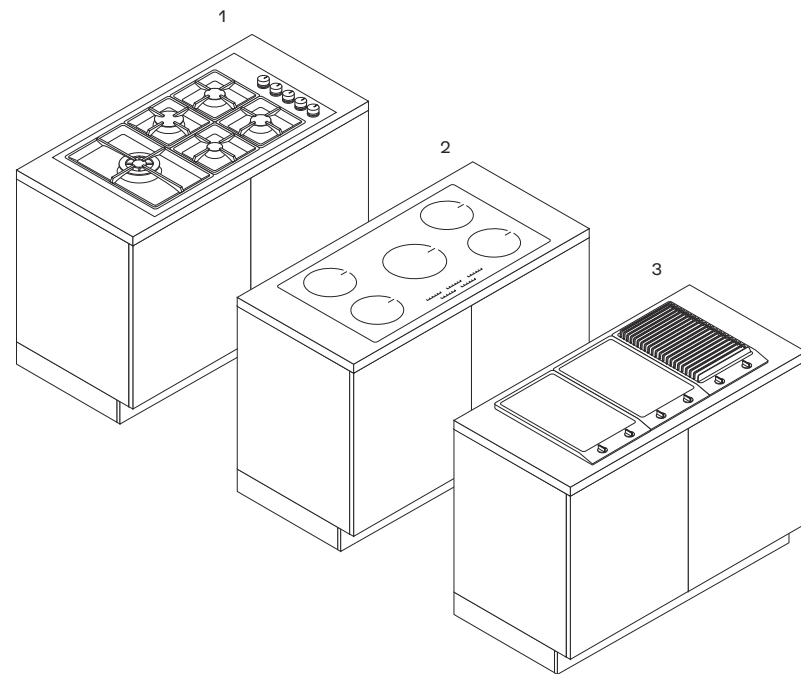

Tipologie di incasso Built-in types

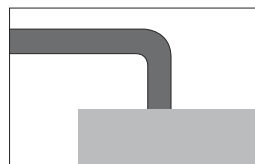

Standard
Standard built-in

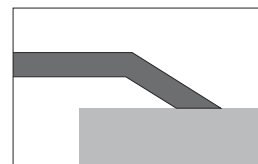

Semifilotop
Semi-flush built-in

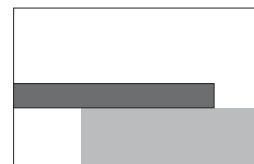

Finotop
Flush built-in

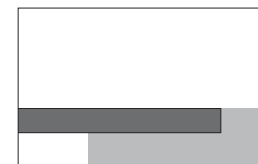

Filotop
Fully flush built-in

LAVELLI SINKS

Tipologie

- 1 Vasca singola.
- 2 Vasca e gocciolatoio.
- 3 Vasca grande e piccola.
- 4 Vasca grande, piccola e gocciolatoio.
- 5 Due vasche.
- 6 Due vasche e gocciolatoio.

Types

- 1 Single basin.
- 2 Basin with drip.
- 3 Big and small basins.
- 4 Big and small basins with drip.
- 5 Two basins.
- 6 Two basins with drip.

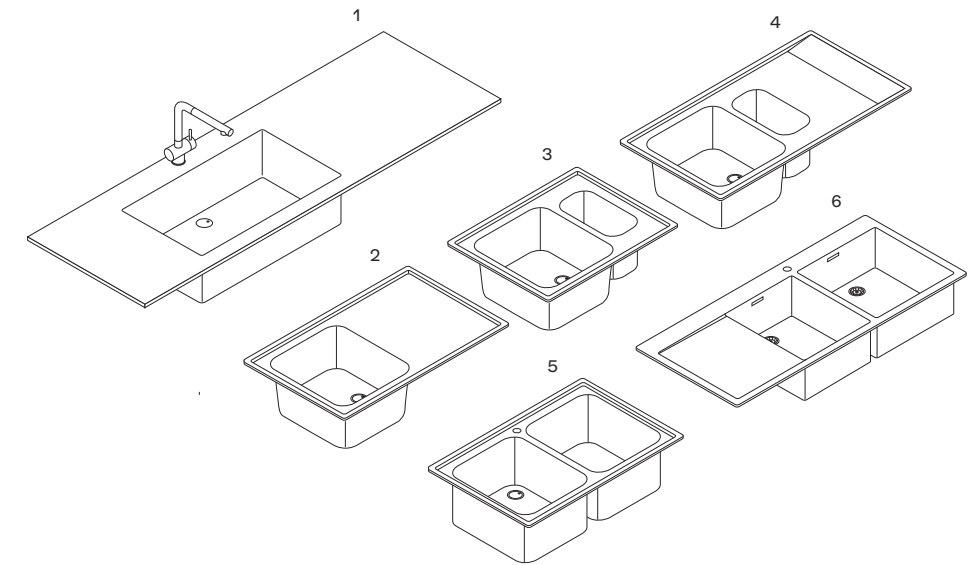

Tipologie di incasso Built-in types



Appoggio h 40 mm
Surface-mounted h 1 1/2"



Incasso
Standard built-in



Finotop
Flush built-in



Filotop
Fully flush built-in

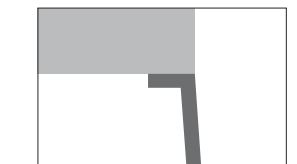

Sottotop
Under-top mounted

CAPPE HOODS

Infinity, sistema modulare

Moduli personalizzati Poliform da assemblare per configurazioni a isola con illuminazione led integrata.

- 1 Modulo aspirante luminoso
l 1050-1200-1500 con carter da 450
l 1800-2400 con carter da 600.
- 2 Modulo fitostimolante luminoso
con teca in vetro bassa o alta
l 600-750-900.
- 3 Modulo luminoso con teca in
vetro bassa o alta
l 600-750-900.
- 4 Modulo luminoso
l 600-750-900-1050-1200.

Infinity, modular system

Poliform personalized modules to be assembled for island configurations with integrated led light.

- 1 Lighted suction module
l 41 1/4"-47 1/4"-59" with carter of 17 3/4"
l 70 3/4"-92 1/2" with carter of 23 1/2".
- 2 Phytostimulant lighted module
with low or high glass case
l 23 1/2"-29 1/2"-35 1/2".
- 3 Lighted module with low or
high glass case
l 23 1/2"-29 1/2"-35 1/2".
- 4 Lighted module
l 23 1/2"-29 1/2"-35 1/2"-41 1/4"-47 1/4".

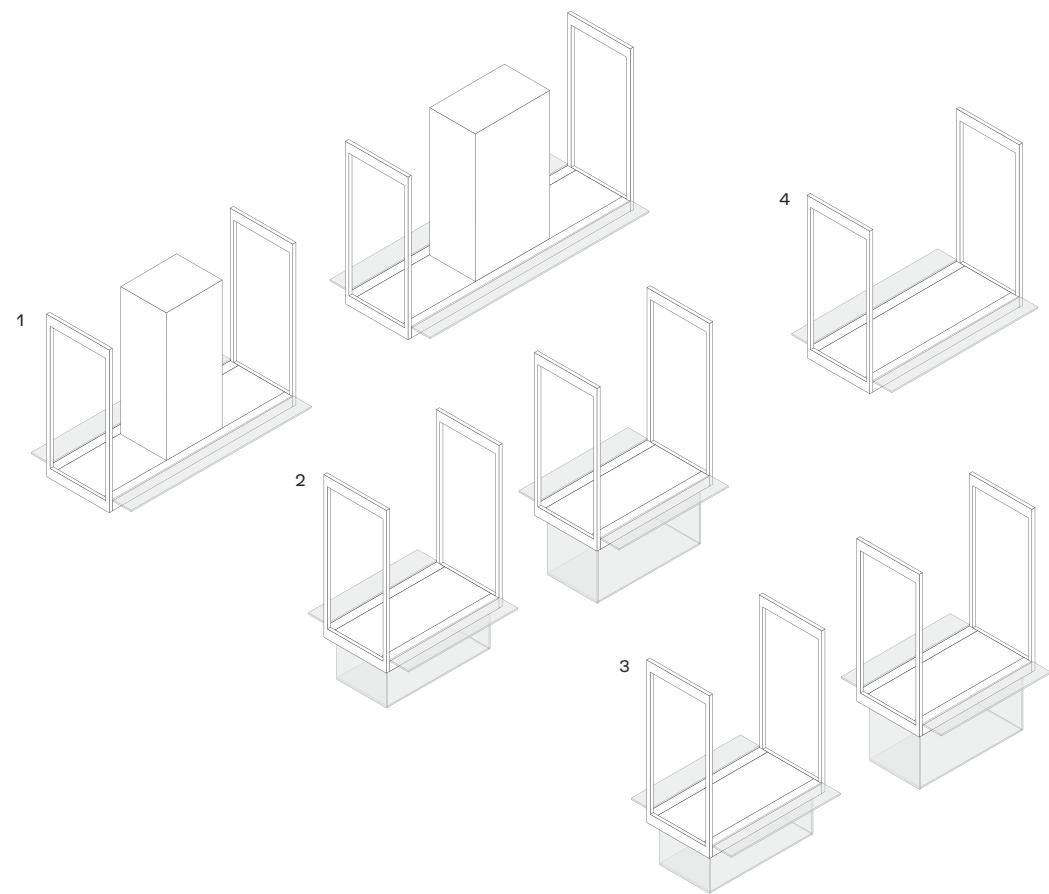

Cappe personalizzate Poliform

- 1 Cappa Piatta a parete e a isola.
- 2 Cappa Factory a isola.
- 3 Cappa Flat a parete e a isola.
- 4 Cappa Box a parete e a isola.
- 5 Cappa Glass a isola.
- 6 Cappa Work a parete e a isola.

Poliform personalised hoods

- 1 Piatta wall mounted, island-hood.
- 2 Factory island-hood.
- 3 Flat wall mounted, island-hood.
- 4 Box wall mounted, island-hood.
- 5 Glass island-hood.
- 6 Work wall mounted, island-hood.

Cappe integrate

- 7 Cappa a scomparsa.
- 8 Cappa Easy integrata nel pensile,
per piani cottura a gas o induzione.
- 9 Cappa Downdraft a scomparsa
nel top.

Integrated hoods

- 7 Retractable hood.
- 8 Easy built-in hood in the wall unit,
for gas or induction hobs.
- 9 Downdraft retractable hood
in the top.

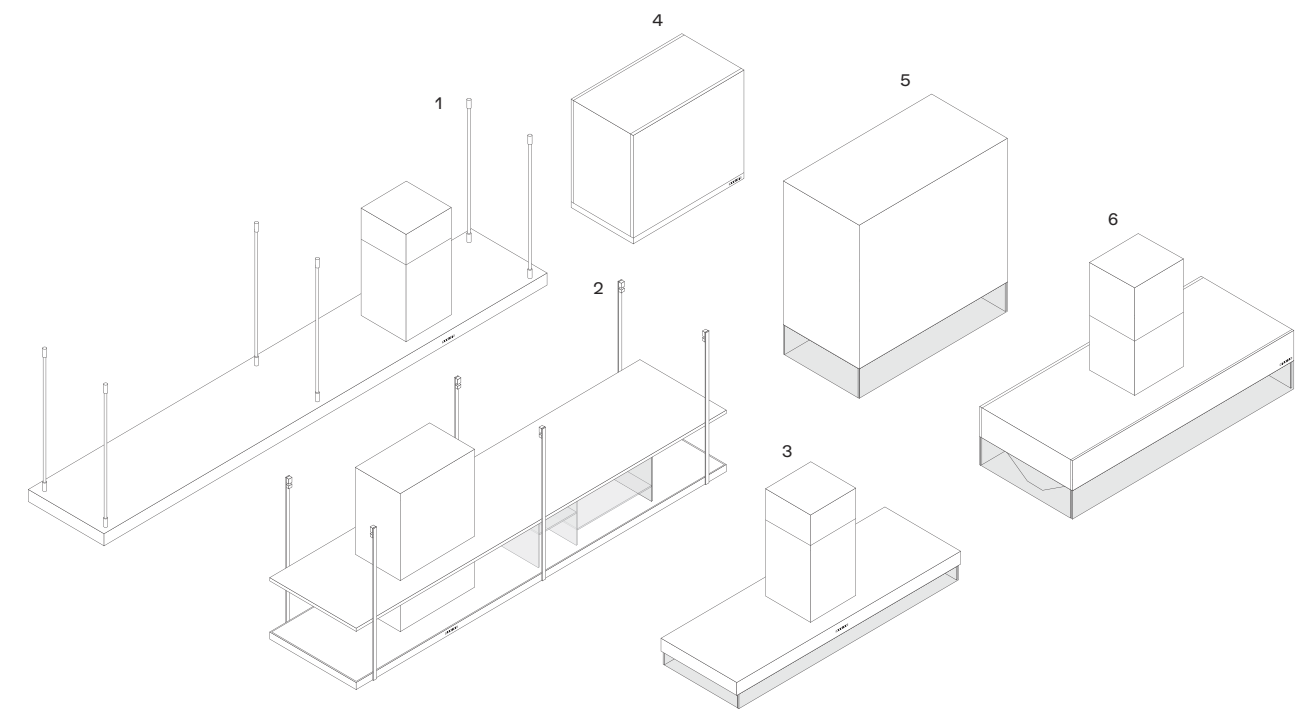

Cappe integrate Integrated hoods

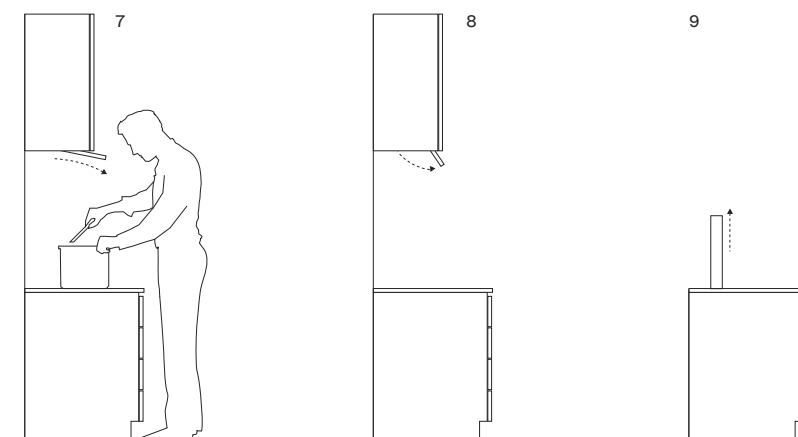

PORTARIFIUTI WASTEBINS

Basi con portarifiuti

- 1 Base livello con due estrattori o estrattore unico
1A - pattumiera raccolta differenziata T2 l 600-750-900-1050-1200 h 260.
1B - Kit sottovasca.
- 2 Base con estrattore unico
2A - pattumiera P-One l 450-600 h 550.
- 3 Base livello con estrattore unico
3A - pattumiera P-One l 600 h 360.
- 4 Base livello con anta battente
4A - pattumiera estraibile l 260 h 350.
4B - pattumiere ad estrazione totale l 275-390 h 380.
4C - pattumiera raccolta differenziata l 600-900-1200 h 360.

Base units with waste bins

- 1 Base unit with two pull-out baskets or single basket.
1A - waste bin for separate waste collection T2 - w 23 1/2"-29 1/2"- 35 1/2"-41 1/4"- 47 1/4" h 10 1/4"
1B - Sink base kit.
- 2 Base unit with single pull-out basket.
2A -waste bin P-One w 17 3/4"-23 1/2" h 21 3/4".
- 3 Sink base unit with single pull-out basket
3A - waste bin P-One w 23 1/2" h 14 1/4".
- 4 Sink base unit with leaf door.
4A - pull-out waste bin w 10 1/4" h 13 3/4".
4B - waste bin with full extension glides w 10 3/4"-15 1/4" h 15".
4C - waste bin for separate waste collection w 23 1/2"-35 1/2"-47 1/4" h 14 1/4".

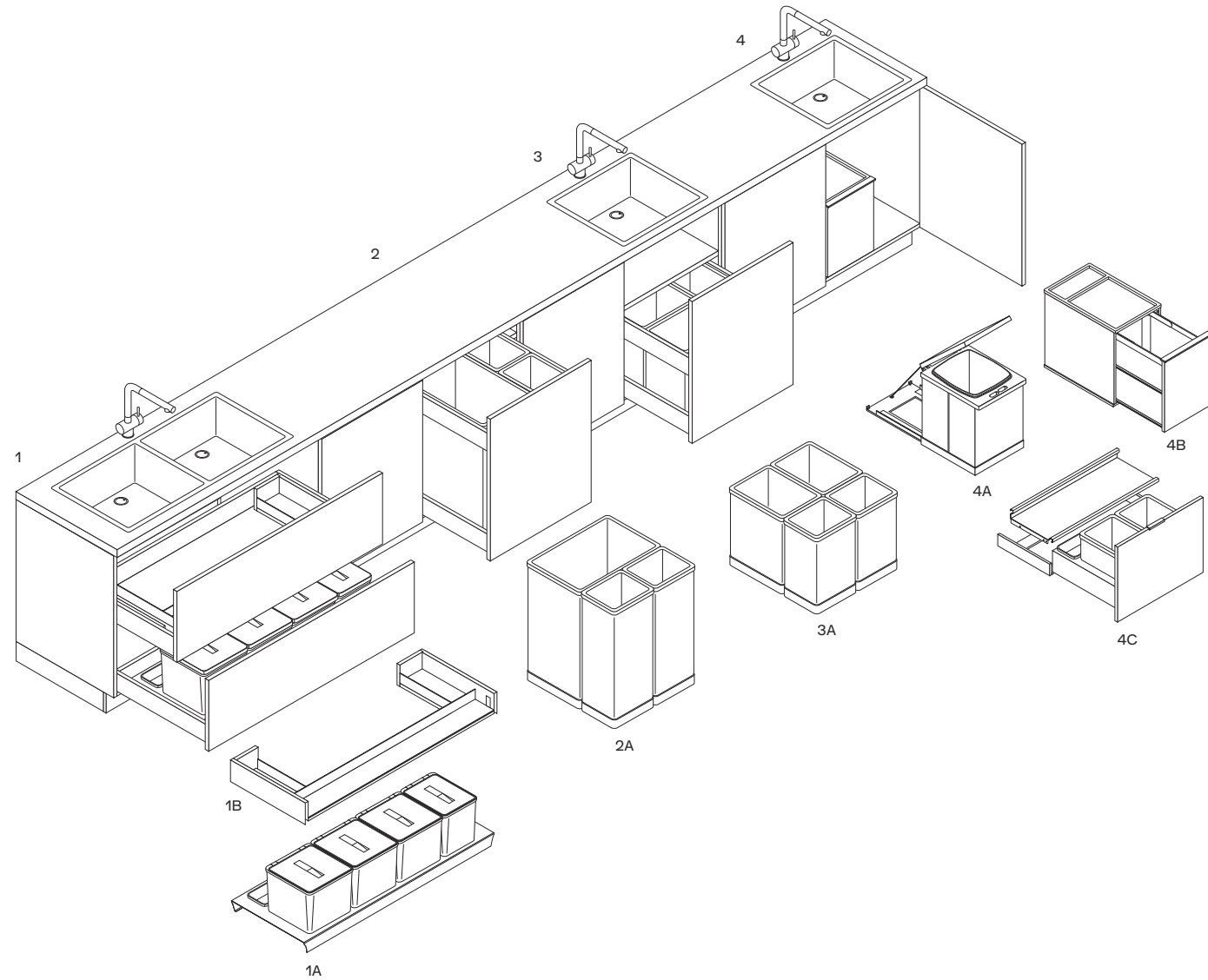

SOLUZIONI DI ILLUMINAZIONE LIGHTING SOLUTIONS

Illuminazione sul piano di lavoro

- 1 Sagoma con illuminazione multiled.
- 2 Faretto integrati sottopensile multiled.
- 3 Barra retrospensile multiled.
- 4 Barra sottopensile luminosa multiled.

Lighting on worktop

- 1 Profile with multiled lighting.
- 2 Built-in multiled spotlights.
- 3 Multiled bar to the back of the wall unit.
- 4 Multiled lighted bar under wall unit.

Multiled interno contenitori

- 5 Cassetti.
- 6 Estrattori.
- 7 Ante battenti.
- 8 Pensili.
- 9 Colonne.

Units internal multiled

- 5 Drawers.
- 6 Pull-out baskets.
- 7 Leaf doors.
- 8 Wall units.
- 9 Tall units.

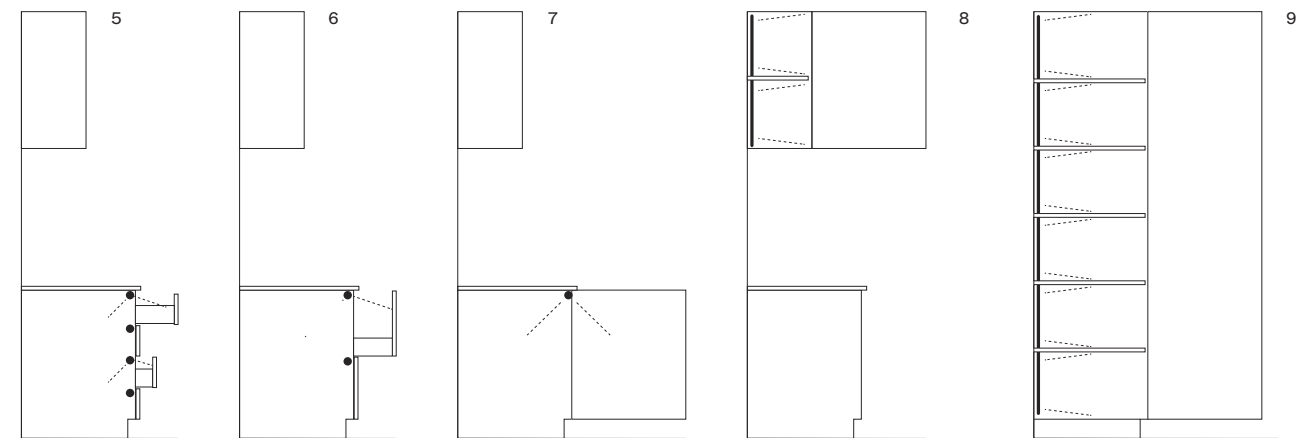
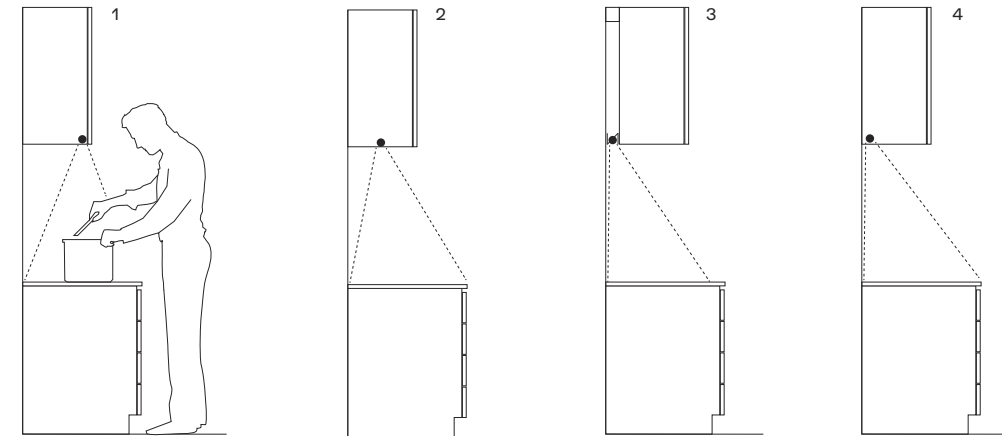

PIANI SNACK SNACK TABLES

Modelli e caratteristiche

- 1 Snack sp. 80 due lati folding con telaio. Da utilizzare sospeso o con gambe. Piano dogato in rovere, rovere spessart, rovere tinto grigio, rovere cenere, olmo nero, noce nazionale o massello di noce canaletto. Gambe e traversi alluminio finitura acciaio o laccato goffrato colori. l da 1800 a 2700 - passo 300 p 900-950-1050-1150-1200-1280.
- 2 Snack sp. 80 quattro lati folding. Da utilizzare sospeso o con gambe. Piano dogato in rovere, rovere spessart, rovere tinto grigio, rovere cenere, olmo nero, noce nazionale o massello di noce canaletto. Gambe cilindriche acciaio. l da 1800 a 2700 - passo 300 p 900-950-1050-1150-1200-1280.
- 3 Snack sp. 52. Da utilizzare su top sp. 6-12-20 con telaio di supporto alluminio previsto per modelli Artex, Twelve, Phoenix e Trail. Piano in rovere, rovere spessart, rovere tinto grigio, rovere cenere, olmo, olmo nero o noce c.; massello di noce nazionale, black ash o tinto olmo nero; laminato tuttocolore, laminato tuttocolore touch, laccato goffrato colori o in DuPont Corian®. Sui piani in laminato è previsto sul bordo un inserto in tinta o a contrasto nei colori dei laminati. l fino a 3000 snack laccati o legno l fino a 3600 snack in DuPont Corian® l fino a 4100 snack in laminato Sporgenza minima dalle basi 350 mm.
- 4 Snack sp. 80 a penisola quadrato. Da utilizzare su top sp. 6-12 con telaio di supporto alluminio previsto per modelli Twelve, Phoenix e Trail e sui top sp. 20. Piano dogato e gamba di sostegno in rovere, rovere spessart, rovere tinto grigio, rovere cenere, olmo nero o massello di noce canaletto. l 1500 x 1500 - 1800 x 1800.
- 5 Snack Moon sp. 40. Ø 1500 con due gambe. Ø 1800 con tre gambe e piano centrale girevole integrato. Piano in rovere fossile, black ash o olmo nero, gambe e inserto finta gamba in massello di rovere fossile, black ash o tinto olmo nero. Piano centrale girevole in tutti i marmi e pietre previste in collezione.

- 6 Snack Sydney sp. 40. Da utilizzare sospeso o con gamba. Piano e gamba in massello di noce, black ash o tinto olmo nero. Sydney l 1550-1700-1850-2150 x 788 l 2450 x 895. Sydney con gamba l 1850 x 900 - 2150 x 1000.
- 7 Snack Blade sp. 40. Da utilizzare sospeso o con gambe. Piano e gambe in massello di noce canaletto, black ash o tinto olmo nero. La lunghezza dello snack rettangolare si può personalizzare al centimetro. Rettangolare da l 1400 a l 2700, p 900-950-1050-1150-1200-1280. Quadrato 1500 x 1500.

Models and features

- 1 Snack th. 3 1/4" with two sides "folding" and frame. For suspended use or with legs. Slatted top in oak, spessart oak, dyed grey oak, cenere oak, black elm, Italian walnut or solid walnut canaletto. Legs and aluminium crossbars finish steel or embossed lacquer colours. w from 70 3/4" to 106 1/4" - pitch 11 3/4" d 35 1/2"-37 1/2"-41 1/4"-45 1/4"-47 1/4"-50 1/2".
- 2 Snack th. 3 1/4" four sides "folding". For suspended use or with legs. Slatted top in oak, spessart oak, dyed grey oak, cenere oak, black elm, Italian walnut or solid walnut canaletto. Cylindrical legs in steel. w from 70 3/4" to 106 1/4" - pitch 11 3/4" d 35 1/2"-37 1/2"-41 1/4"-45 1/4"-47 1/4"-50 1/2".
- 3 Snack th. 2". To be used on worktop th. 1/4"-1/2"-3/4" with aluminium supporting frame for the models Artex, Twelve, Phoenix and Trail. Top in oak, spessart oak, grey stained oak, cenere oak, elm, black elm or walnut c.; solid Italian walnut, black ash or stained black elm; laminate tuttocolore, laminate tuttocolore touch, embossed lacquer colours or in DuPont Corian®. On the edge of the laminate worktops, an inlay in contrast or matching colour is available. w up to 118" snack in lacquer or wood w up to 141 3/4" snack in DuPont Corian® w up to 161 1/2" snack in laminate Minimum overhang of the base units 13 3/4".
- 4 Square peninsula snack th. 3 1/4". To be used on worktop th. 1/4"-1/2" with supporting aluminium frame for the models Twelve, Phoenix and Trail and on worktops th. 3/4". Slatted top and supporting leg in oak, spessart oak, grey stained oak, cenere oak, black elm or solid walnut canaletto. w 59" x 59" - 70 3/4" x 70 3/4".
- 5 Snack Moon th. 1 1/2". Ø 59" with two legs. Ø 70 3/4" with three legs and swivel integrated central top. Top in fossil oak, black ash or black elm, legs and inlay as a leg in solid fossil oak, black ash or stained black elm. Swivel central top in all the marbles and stones in the collection.
- 6 Snack Sydney th. 1 1/2". For suspended use or with leg. Top and leg in solid walnut, black ash or stained black elm. Sydney w 61"-67"-72 3/4"-84 3/4" x 31" w 96 1/2" x 35 1/4". Sydney with leg w 72 3/4" x 35 1/2" - 84 3/4" x 39 1/4".
- 7 Snack Blade th. 1 1/2". For suspended use or with legs. Top and legs in solid walnut canaletto, black ash or stained black elm. The length of the rectangular snack can be customized to the centimeter. Rectangular from w 55" to 106 1/4", d 35 1/2"-37 1/2"-41 1/4"-45 1/4"-47 1/4"-50 1/2". Square 59" x 59".

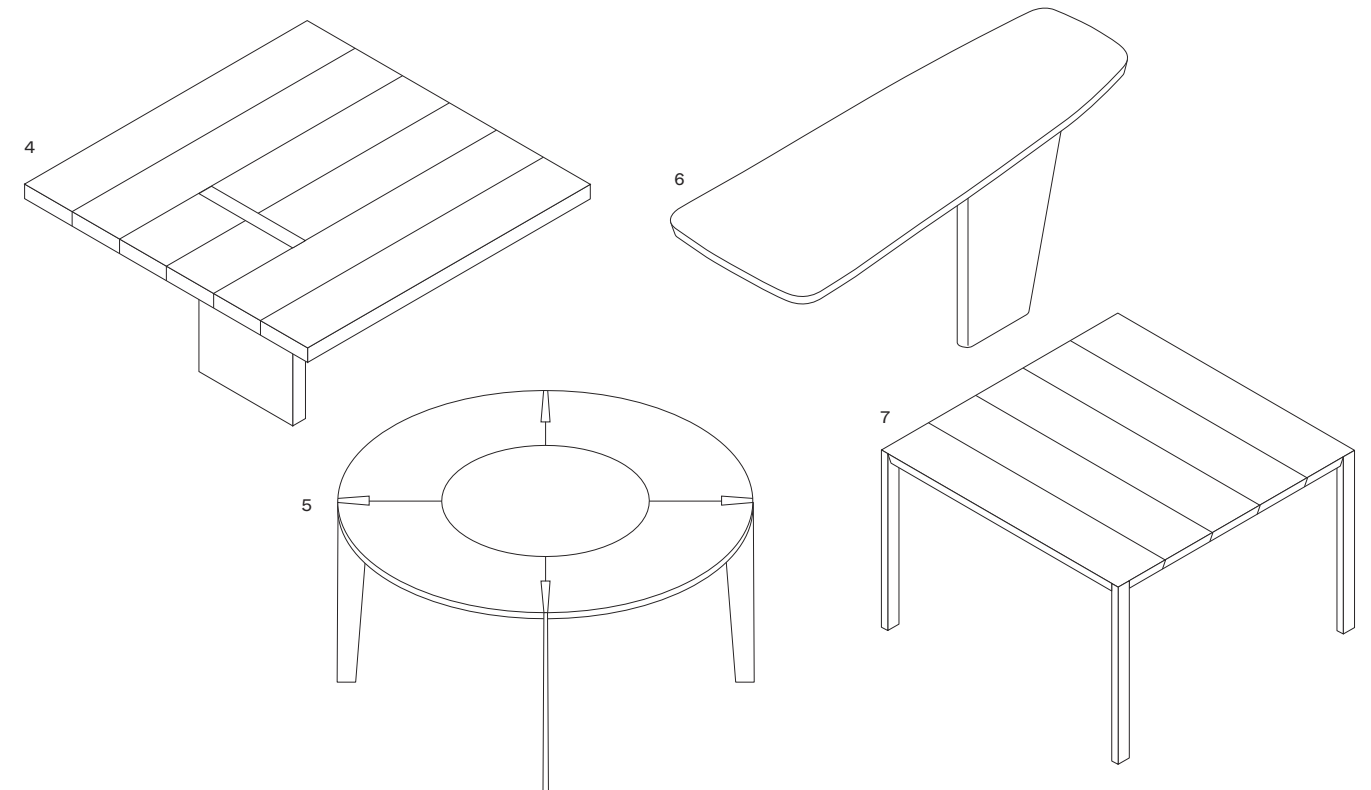
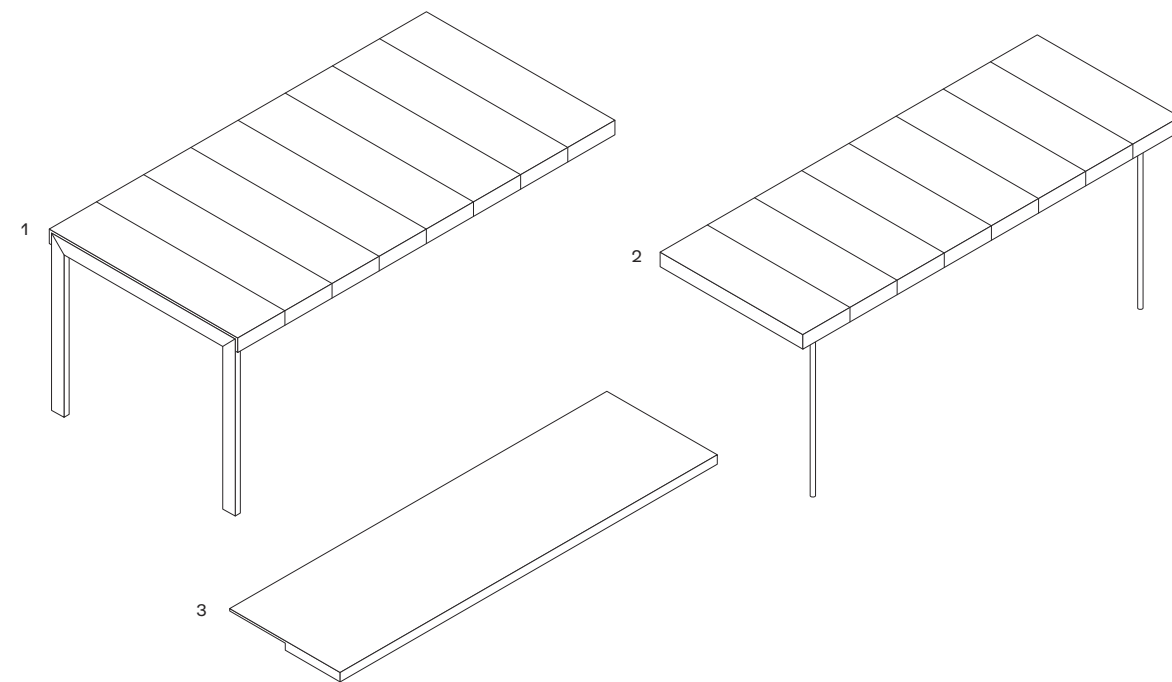

TAVOLI TABLES



Kensington
Design Jean-Marie Massaud, 2018

Struttura in alluminio spatolato ferro e bronzo o laccato opaco champagne. Piano in olmo nero, vetro fumé, marmo lucido noir saint laurent, marmo levigato e lucido bianco carrara, grigio stardust, calacatta oro o sahara noir finitura poliestere.

Il piano è caratterizzato dall'accostamento di moduli di forme e misure diverse.

Structure in aluminium with spatula finish ferro and bronzo or champagne mat lacquered. Top in black elm, fumé glass, glossy marble noir saint laurent, mat and glossy marble bianco carrara, grigio stardust,



calacatta oro or sahara noir with polyester finish. The top is distinguished by the combination of modules with different shape and size.

Dimensioni mm: rettangolare 2600 x 1200 3000 x 1200 h 740

rotondo Ø 1600 - Ø 2000 h 740

Dimensions in: rectangular 102 1/4" x 47 1/4"

118" x 47 1/4" h 29 1/4"

round Ø 63" - Ø 78 3/4" h 29 1/4"



Henry
Design Emmanuel Gallina, 2019

Tavolo fisso o allungabile. Struttura in olmo nero o noce gold. Piano in olmo nero, noce gold, cinque marmi levigati e sei lucidi, vetro lucido nei colori ghiaccio, arena, grafite, bordeaux. Allungabile solo in essenza. Fixed or extendable table. Structure in black elm or walnut gold finish. Top in black elm, walnut gold, five mat marbles and six glossy marbles, glossy glass in the colours ghiaccio, arena, grafite, bordeaux. Extendable table only version in wood.

Dimensioni mm: rettangolare 2400 x 1080 - 2850 x 1080 h 740, quadrato 1700 x 1700 h 740 allungabile 1800/2400 x 1000 h 740

Dimensions in: rectangular 94 1/2" x 42 1/2" - 112 1/4" x 42 1/2" h 29 1/4", square 67" x 67" h 29 1/4" extendable 70 3/4"/94 1/2" x 39 1/4" h 29 1/4"



Concorde
Design Emmanuel Gallina, 2009

Struttura in massello, finitura in noce gold, noce c., rovere spessart, rovere cenere o olmo nero. Piano in noce gold, noce c., rovere spessart, rovere cenere, olmo nero, cinque marmi levigati e sei lucidi. Per le versioni rettangolari è disponibile anche il piano in vetro lucido colori o in vetro riflettente blu con cornice in essenza. Per i tavoli Ø 1800 e 2000 mm è previsto un piano girevole opzionale in appoggio in laccato opaco colori, laccato lucido colori, noce gold, noce c., rovere spessart, rovere cenere, olmo nero, cinque marmi levigati e sei lucidi.



Structure in solid wood finish in walnut gold, walnut c., spessart oak, cenere oak or black elm. Top in walnut gold, walnut c., spessart oak, cenere oak, black elm, five mat and six glossy marble finishes. For the rectangular versions, the tabletop is available also in glossy glass or in blue reflecting glass with wooden frame. For the tables Ø 70 3/4" and 78 3/4" mm an optional swivel tray lean on the tabletop in the following finishes is available: mat lacquered colours, glossy lacquered colours, walnut gold, walnut c., spessart oak, cenere oak, black elm, five mat and six glossy marble finishes.



Dimensioni mm: rettangolare 2185 x 1080 - 2400 x 1080 - 2800 x 1080 h 740 rotondo Ø 1370 - Ø 1800 - Ø 2000 h 740 Ø 1800 piano girevole opzionale Ø 900 Ø 2000 piano girevole opzionale Ø 1050 Dimensions in: rectangular 86" x 42 1/2" - 94 1/2" x 42 1/2" - 110 1/4" x 42 1/2" h 29 1/4" round Ø 54" - Ø 70 3/4" - Ø 78 3/4" h 740 Ø 70 3/4" optional spinning tray Ø 35 1/2" Ø 78 3/4" optional spinning tray Ø 41 1/4"



Mondrian
Design Jean-Marie Massaud, 2019

Struttura in fusione di alluminio, finitura brown nickel opaco o champagne opaco.

Piano in olmo nero, noce gold, vetro fumé, cinque marmi levigati e sei lucidi.

Structure in aluminium casting, finish mat brown nickel or mat champagne.

Top in black elm, walnut gold, fumé glass, five mat marbles and six glossy marbles.



Dimensioni mm: ellittico 2400 x 1220 - 2800 x 1300 h 740

rotondo Ø 1400 - Ø 1600 h 740

Dimensions in: ellittico 94 1/2" x 48" -

110 1/4" x 51 1/4" h 29 1/4"

round Ø 55" - Ø 63" h 29 1/4"



Blade
Design R&D Poliform, 2014

Struttura e piano in massello di noce canaletto, massello black ash o massello tinto olmo nero. Nella versione rettangolare la lunghezza del tavolo si può personalizzare al centimetro.

Structure and top in solid canaletto walnut, solid black ash or solid wood stained black elm. The length of the rectangular table can be customized. Dimensioni mm: quadrato 1100 x 1100 - 1400 x 1400 rettangolare da 1400 a 3000 x 1100 h 740

Dimensions in: square 43 1/4" x 43 1/4" - 55" x 55" rectangular from 55" to 118" x 43 1/4" h 29 1/4"



Home Hotel
Design Jean-Marie Massaud, 2016

Struttura in massello finitura olmo nero o massello noce gold. Piano in olmo nero, cinque marmi levigati e sei lucidi. Versione in noce gold disponibile solo con piano in marmo.

I tavoli Ø 1800 e 2000 mm hanno un piano girevole integrato in olmo nero, noce gold, cinque marmi levigati e sei lucidi. Per i tavoli Ø 1800 e 2000 con piani in marmo, il piano girevole è disponibile solo in olmo nero o noce gold.

Structure in solid wood finish black elm or solid walnut gold. Top in black elm, five mat marbles and six glossy



marbles. Version in walnut gold available only with top in marble. The tables Ø 70 3/4" and 78 3/4" have an integrated swivel top in black elm, walnut gold, five mat and six glossy marble finishes. For tables Ø 70 3/4" and 78 3/4" with marble top the swivel top is available only in black elm or walnut gold.

Dimensioni mm: rettangolare 2400 x 1100 3000 x 1100 h 740

rotondo Ø 1600 - Ø 1800 - Ø 2000 h 740

Ø 1800 piano girevole integrato Ø 900

Ø 2000 piano girevole integrato Ø 1100



Dimensions in: rectangular 94 1/2" x 43 1/4" - 118" x 43 1/4" h 29 1/4" round Ø 63" - Ø 70 3/4" - Ø 78 3/4" h 29 1/4" Ø 70 3/4" integrated spinning tray Ø 35 1/2" Ø 78 3/4" integrated spinning tray Ø 43 1/4"



Opéra
Design Emmanuel Gallina, 2014

Tavolo fisso o allungabile. Struttura in noce c. o rovere spessart. Piano in noce c., rovere spessart, cinque marmi levigati e sei lucidi. Nel tavolo allungabile con piano in marmo finitura prolunghe come la struttura. Fixed or extendable table. Structure in walnut c. or spessart oak. Top in walnut c., spessart oak, five mat and six glossy marble finishes. The extensions of the extendable table with marble top are in the same finish of the structure.

Dimensioni mm: fisso 2880 x 1100 h 740 allungabile 2080/2980 x 969 h 740

Dimensions in: fixed 113 1/2" x 43 1/4" h 29 1/4" extensible 82"/117 1/4" x 38 1/4" h 29 1/4"



Flute
Design Roberto Barbieri, 2008

Struttura laccato opaco colori, laccato lucido colori, laccato antigraffio o verniciato brown nickel opaco e lucido. Piano laccato opaco colori, laccato lucido colori, laccato antigraffio nei colori bianco 01, carbone 91, grafite 04, canapa 35, cinque marmi levigati e sei lucidi. Structure in mat lacquered colours, glossy lacquered colours, anti-scratch lacquered colours or brown nickel mat and glossy finishes. Top in mat lacquered colours, glossy lacquered colours, anti-scratch lacquer in the colours bianco 01, carbone 91, grafite 04, canapa 35, five mat and six glossy marble finishes.

Dimensioni mm: piano laccato Ø 900 - Ø 1250 - Ø 1400 - piano marmo Ø 900 - Ø 1230 - Ø 1370 h 740

Dimensions in: lacquered top Ø 35 1/2" - Ø 49 1/4" - Ø 55" - marble top Ø 35 1/2" - Ø 48 1/2" - Ø 54" h 29 1/4"



Howard
Design Jean-Marie Massaud, 2011

Struttura in massello, finitura in rovere spessart o olmo nero. Telaio in metallo tagliato a laser e piegato, verniciato brown nickel opaco. Piano in rovere spessart, cinque marmi levigati e sei lucidi.

Structure in solid wood, finishes spessart oak or black elm. Frame in laser cut and folded metal painted mat brown nickel. Top in spessart oak, five mat and six glossy marble finishes.

Dimensioni mm: 2200 x 1000 - 2800 x 1100 h 740

Dimensions in: 86 1/2" x 39 1/4" - 110 1/4" x 43 1/4" h 29 1/4"



Mad Dining Table
Design Marcel Wanders, 2015

Struttura in massello, finitura in rovere spessart o olmo nero. Piano in rovere spessart, olmo nero, cinque marmi levigati e sei lucidi.

Structure in solid wood, spessart oak or black elm finish. Top in spessart oak, black elm, five mat and six glossy marble finishes.

Dimensioni mm: 2200 x 1100 - 2790 x 1100 h 740

Dimensions in: 86 1/2" x 43 1/4" - 109 3/4" x 43 1/4" h 29 1/4"



Gill
Design Roberto Barbieri, 2010

Tavolo allungabile. Struttura in massello, finitura in rovere spessart. Piano in rovere spessart. Extendable table. Structure in solid wood spessart oak finish. Top in spessart oak.

Dimensioni mm: 1550/2100 x 900 h 740

1800/2350 x 900 h 740

2000/2620 x 1000 h 740

Dimensions in: 61"/82 3/4" x 35 1/2" h 29 1/4"

70 3/4"/92 1/2" x 35 1/2" h 29 1/4"

78 3/4"/103 1/4" x 39 1/4" h 29 1/4"



Trevi
Design Roberto Barbieri, 2005

Struttura in trafilato alluminio laccato opaco colori, laccato antigraffio o verniciato brown nickel opaco e lucido. Piano laccato opaco colori o laccato antigraffio nei colori bianco 01, carbone 91, grafite 04 e canapa 35. Structure in extruded aluminium in the finishes mat lacquered colours, anti-scratch lacquer or brown nickel mat and glossy. Top in mat lacquered colours, or anti-scratch lacquer in the colours bianco 01, carbone 91, grafite 04, canapa 35.

Dimensioni mm: quadrato 900 x 900 - 1250 x 1250 rettangolare 1400 x 800 - 1800 x 900 h 740

Dimensions in: square 35 1/2" x 35 1/2" - 49 1/4" x 49 1/4" rectangular 55" x 31 1/2" - 70 3/4" x 35 1/2" h 29 1/4"

SEDIE CHAIRS



Stanford Bridge
Design Jean-Marie Massaud, 2018

Scocca imbottita e rivestimento non sfoderabile in tessuto o pelle. Basamento girevole con ritorno, in brown nickel opaco e lucido o champagne opaco. Body upholstered and covered in non-removable fabric or leather. Base with automatic returning mechanism, in mat and glossy brown nickel or mat champagne. Dimensioni mm: sedia | 570 p 560 h 800 sedia con braccioli | 620 p 560 h 800 Dimensions in: chair w 22 1/2" d 22" h 31 1/2" chair with arms w 24 1/2" d 22" h 31 1/2"



Sophie
Design Emmanuel Gallina, 2017

Seduta imbottita e rivestimento non sfoderabile in tessuto o pelle. Struttura in noce gold, rovere spessart o olmo nero. Seat upholstered and covered in non-removable fabric or leather. Structure in walnut gold, spessart oak or black elm. Dimensioni mm: sedia | 570 p 600 h 780 sedia con braccioli | 630 p 600 h 780 dimensions in: chair w 22 1/2" d 23 1/2" h 30 3/4" chair with arms w 24 3/4" d 23 1/2" h 30 3/4"



Grace
Design Emmanuel Gallina, 2009

Seduta imbottita e rivestimento non sfoderabile in tessuto, pelle o pelle Nabuk intrecciata (solo per retro schienale). Struttura in noce gold, noce c., rovere cenere, rovere spessart o olmo nero. Seat upholstered and covered in non-removable fabric, leather or woven leather Nabuk (available only for the rear of the backrest). Structure in walnut gold, walnut c., cenere oak, spessart oak or black elm. Dimensioni mm: con/senza braccioli | 535 p 540 h 815 Dimensions in: with/without arms w 21" d 21 1/4" h 32"



Seattle
Design Jean-Marie Massaud, 2015

Seduta e schienale completamente rivestiti in cuoio non sfoderabile nei colori 19 caffè, 02 nero, 26 invecchiato o 29 tortora con punzonatura estetica (brogueing) perimetrale. Gambe in rovere spessart, rovere naturale e olmo nero o completamente rivestite in cuoio nei colori 19 caffè, 02 nero, 26 invecchiato o 29 tortora. Seat and backrest fully covered in non-removable hide in the colours 19 caffè, 02 nero, 26 invecchiato or 29 tortora with perimeter decorative punching

(brogueing). Legs in spessart oak, natural oak and black elm or fully covered in hide in the colours 19 caffè, 02 nero, 26 invecchiato or 29 tortora. Dimensioni mm: sedia | 530 p 550 h 790 sedia con braccioli | 560 p 550 h 790 Dimensions in: chair w 20 3/4" d 21 3/4" h 31" chair with arms w 22" d 21 3/4" h 31"



Ipanema
Design Jean-Marie Massaud, 2015

Seduta imbottita e rivestimento non sfoderabile in tessuto o pelle. Struttura in rovere spessart o olmo nero. Seat upholstered and covered in non-removable fabric or leather. Structure in spessart oak or black elm. Dimensioni mm: sedia | 540 p 545 h 815 sedia con braccioli | 575 p 545 h 815 Dimensions in: chair w 21 1/4" d 21 1/2" h 32" chair with arms w 22 3/4" d 21 1/2" h 32"



Ventura
Design Jean-Marie Massaud, 2011

Scocca imbottita e rivestimento non sfoderabile in tessuto o pelle. Cucitura normale doppia o solo per la versione in tessuto (escluso velluto) cucitura a cordoncino in tinta. Struttura in rovere cenere, rovere spessart o olmo nero. Body upholstered and covered in non-removable fabric or leather. Double normal stitching or drawstring stitching in matching colour, only for the version in fabric (except velvet). Structure in cenere oak, spessart oak or black elm.



Dimensioni mm: sedia | 505 p 540 h 815 sedia con braccioli | 555 p 540 h 815 Dimensions in: chair w 20" d 21 1/4" h 32" chair with arms w 21 3/4" d 21 1/4" h 32"



Ventura
Design Jean-Marie Massaud, 2011

Scocca imbottita e rivestimento non sfoderabile in tessuto o pelle. Struttura in metallo verniciato brown nickel opaco o laccato opaco colori. Body upholstered and covered in non-removable fabric or leather. Structure in mat or glossy brown nickel painted metal. Dimensioni mm: sedia | 505 p 540 h 815 sedia con braccioli | 555 p 540 h 815 Dimensions in: chair w 20" d 21 1/4" h 32" chair with arms w 21 3/4" d 21 1/4" h 32"



Mad Dining Chair
Design Marcel Wanders, 2015

Scocca imbottita e rivestimento non sfoderabile in tessuto o pelle. Possibilità di rivestimento diverso tra interno ed esterno della scocca. Il rivestimento Gibson matelassé è disponibile solo per la scocca interna. Gambe in rovere spessart o olmo nero. Body upholstered and covered in non-removable fabric or leather. The inner and outer cover can be in two different materials. Fabric Gibson matelassé is available only for the inner cover. Legs in solid wood in the finishes spessart oak or black elm.

Dimensioni mm: sedia | 480 p 575 h 790 sedia con braccioli | 630 p 575 h 790 dimensions in: chair w 19" d 22 3/4" h 31" chair with arms w 24 3/4" d 22 3/4" h 31"



Harmony
Design Rodrigo Torres, 2012

Scocca in legno curvato con tecnica 3d finitura rovere spessart. Struttura in massello, finitura rovere spessart o in tondino di metallo finitura in cromo nero. Body in curved wood with 3D technology, finish spessart oak. Structure in solid wood spessart oak finish or in metal rod in black chrome finish. Dimensioni mm: | 460 p 480 h 795 Dimensions in: w 18" d 19" h 31 1/4"



Guest
Design Rodolfo Dordoni, 2014

Scocca imbottita e rivestimento non sfoderabile in tessuto o pelle. Cuscino seduta con rivestimento sfoderabile in tessuto o pelle. Ruote a scomparsa. Body upholstered and covered in non-removable fabric or leather. Seat cushion with removable cover in fabric or leather. Invisible wheels. Dimensioni mm: | 575 p 610 h 835 Dimensions in: w 22 3/4" d 24" h 32 3/4"



Velvet
Design R&D Poliform, 2007

Seduta imbottita e rivestimento sfoderabile in tessuto o pelle. Gambe in laccato opaco colori, noce c. o rovere spessart. Seat upholstered and covered in removable fabric or leather. Legs in mat lacquered colour, walnut c. or spessart oak. Dimensioni mm: sedia | 525 p 560 h 770 sedia con braccioli | 580 p 590 h 770 Dimensions in: chair w 20 3/4" d 22" h 30 1/4" chair with arms w 22 3/4" d 23 1/4" h 30 1/4"



Velvet Due
Design R&D Poliform, 2007

Seduta imbottita e rivestimento sfoderabile in tessuto. Gambe in laccato opaco colori, noce c. o rovere spessart. Seat upholstered and covered in removable fabric. Legs in mat lacquered colour, walnut c. or spessart oak. Dimensioni mm: sedia | 575 p 590 h 770 sedia con braccioli | 580 p 590 h 770 Dimensions in: chair w 22 3/4" d 23 1/4" h 30 1/4" chair with arms w 22 3/4" d 23 1/4" h 30 1/4"



Manta
Design Rodrigo Torres, 2007

Seduta e gambe completamente rivestite in pelle non sfoderabile. Seat and legs fully covered in non-removable leather. Dimensioni mm: sedia | 520 p 530 h 770 sedia con braccioli | 570 p 550 h 770 Dimensions in: chair w 20 1/2" d 20 3/4" h 30 1/4" chair with arms w 22 1/2" d 21 3/4" h 30 1/4"



BB
Design Blumer e Borghi, 2008

Struttura completamente rivestita e non sfoderabile in cuoio co-stampato nei colori 02 nero, 03 grigio scuro, 19 caffè o 26 invecchiato. Structure fully covered in non-removable hide in the colours 02 nero, 03 grigio scuro, 19 caffè or 26 invecchiato. Dimensioni mm: | 465 p 535 h 780 Dimensions in: w 18 1/4" d 21" h 31 1/4"

SGABELLI STOOLS



Sophie
Design Emmanuel Gallina, 2018

Seduta e schienale con parti in poliuretano flessibile a quote differenziate e parti in poliuretano flessibile stampato, prerivestimento in fibra di poliestere. Rivestimento non sfoderabile in tessuto o pelle. Struttura in massello, finitura noce gold, rovere spessart o olmo nero. Poggiapiedi in metallo verniciato brown nickel opaco con inserto inox satinato. Seat and back with parts in flexible polyurethane in different densities and parts in moulded flexible

polyurethane, pre-cover in polyester fibre. Non-removable cover in fabric or leather. Structure in solid wood, finish walnut gold, spessart oak or black elm. Footrest in mat brown nickel painted metal with inlay in brushed stainless steel. Dimensioni mm: l 550 p 550 h 660/870 alto l 550 p 550 h 760/970
Dimensions in: w 21 3/4" d 21 3/4" h 26" 34 1/4" high w 21 3/4" d 21 3/4" h 30" 38 1/4"



Ventura
Design Jean-Marie Massaud, 2016

Scocca in poliuretano flessibile stampato, prerivestimento in fibra di poliestere. Rivestimento non sfoderabile in tessuto o pelle. Cucitura normale doppia o solo per la versione in tessuto (escluso velluto) cucitura a cordoncino in tinta. Struttura in massello, finitura rovere spessart o olmo nero. Poggiapiedi in acciaio inox. Body in moulded flexible polyurethane, pre-cover in polyester fibre. Non-removable cover in fabric or leather. Normal double stitching or drawstring

stitching in matching colour only for the fabric version (except velvet). Structure in solid wood, spessart oak or black elm finish. Footrest in stainless steel. Dimensioni mm: l 485 p 470 h 650/850 alto l 485 p 500 h 750/950
Dimensions in: w 19" d 18 1/2" h 25 1/2"/33 1/2" high w 19" d 19 3/4" h 29 1/2"/37 1/2"



Harmony
Design Rodrigo Torres, 2012

Scocca in legno curvato con tecnica 3D, finitura rovere spessart. Struttura in tondino di metallo finitura cromo nero. Body in curved wood with 3D technology, spessart oak finish. Structure in metal rod black chrome finish. Dimensioni mm: l 445 p 450 h 660/815
Dimensions in: w 17 1/2" d 17 3/4" h 26" 32"



Ics
Design Rodrigo Torres, 2010

Seduta in rovere spessart. Struttura in massello, finitura rovere spessart con poggiapiedi in acciaio inox. Seat in spessart oak. Structure in solid wood, spessart oak finish with footrest in stainless steel. Dimensioni mm: l 440 p 340 h 660
Dimensions in: w 17 1/2" d 13 1/2" h 26"

PANCHE BENCHES



Home Hotel
Design Jean-Marie Massaud, 2016

Seduta in olmo nero rivestita in cordatura di pelle testa di moro. Struttura in massello, finitura olmo nero. Cuscino opzionale con rivestimento sfoderabile in tessuto o pelle; nella versione pelle Nabuk possibilità pelle Nabuk intrecciata nella parte superiore. Seat in black elm, covered with dark brown stringed leather. Structure in solid wood, black elm finish. Optional cushion with removable cover in fabric or leather; in the version in leather Nabuk, the upper part can be in woven leather. Dimensioni mm: l 1000 p 490 h 440 l 1440 p 490 h 440
Dimensions in: w 20" d 21 1/4" h 32" w 21 3/4" d 21 1/4" h 32"



Jane
Design Emmanuel Gallina, 2017

Seduta in poliuretano flessibile a quote differenziate, prerivestimento in fibra di poliestere. Rivestimento in tessuto sfoderabile o in pelle non sfoderabile. Struttura in massello, finitura noce gold, rovere spessart o olmo nero. Struttura in metallo verniciato brown nickel opaco o lucido. Seat in flexible polyurethane in different densities, pre-cover in polyester fibre. Cover in removable fabric or in non-removable leather. Structure in solid wood, walnut gold, spessart oak or black elm finish. Structure in mat or glossy brown nickel painted metal. Dimensioni mm: l 1300 p 500 h 480
Dimensions in: w 51 1/4" d 19 3/4" h 19"

FINITURE
FINISHINGS

Laccato gofrato e lucido
Embossed and glossy lacquered

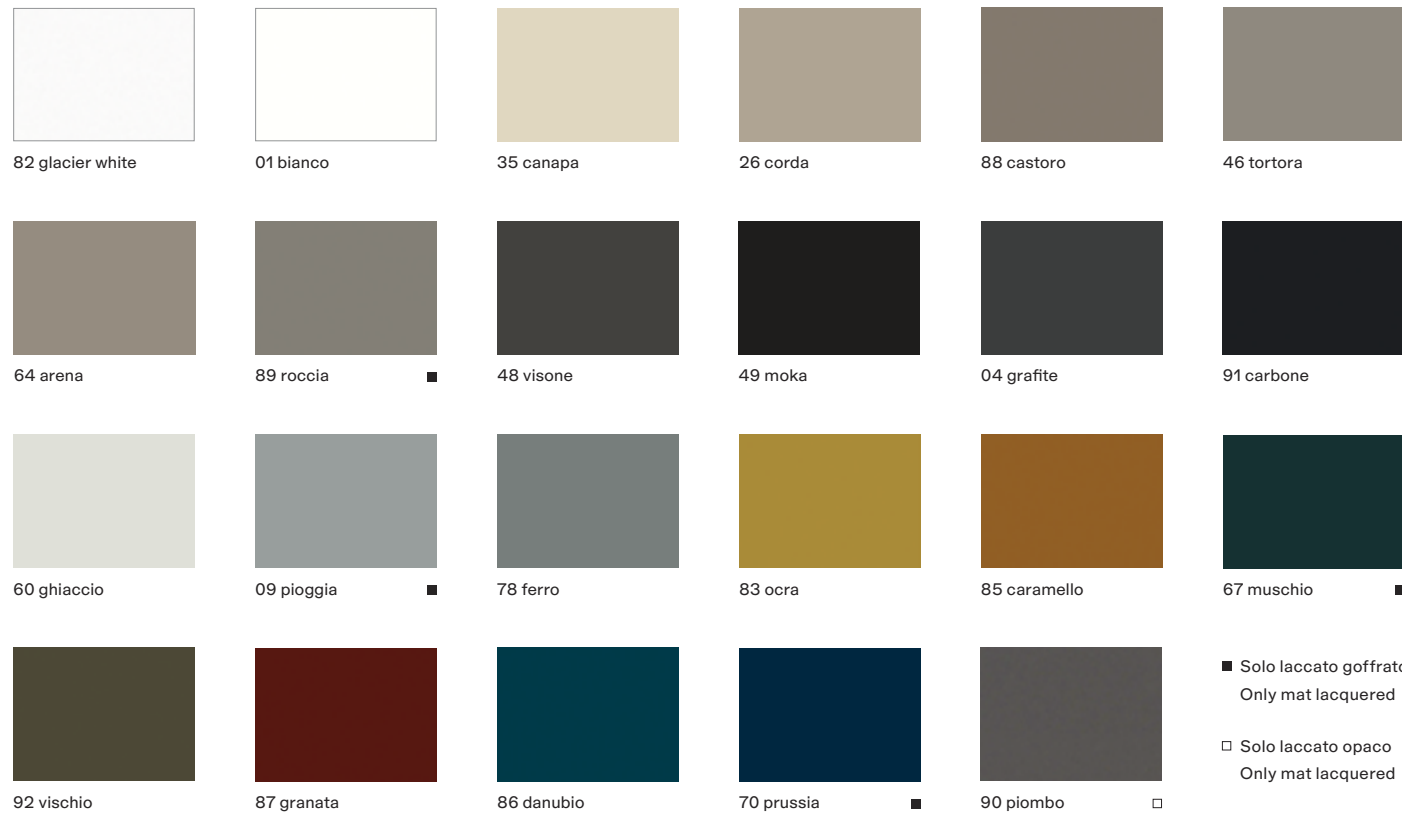

■ Solo laccato gofrato
Only mat lacquered

□ Solo laccato opaco
Only mat lacquered

Laccato metallico
Metallic lacquered

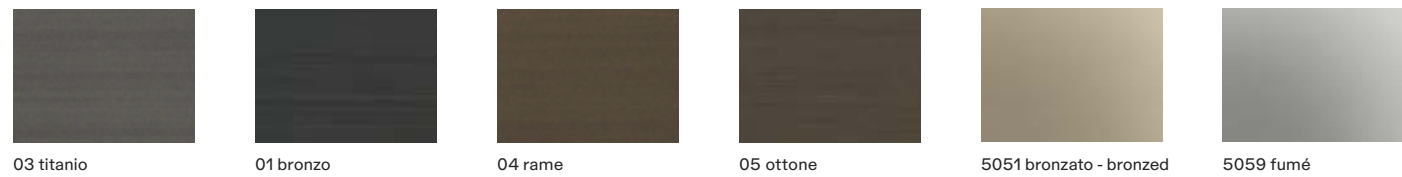

Vetro riflettente
Reflecting glass

Vetro satinato
Frosted glass

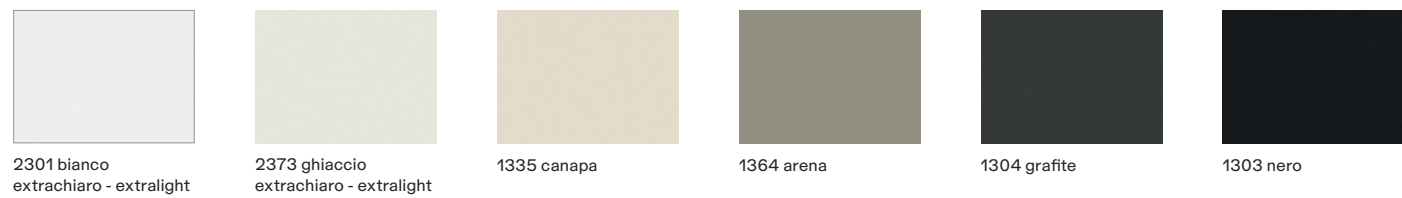

Vetro lucido
Glossy glass

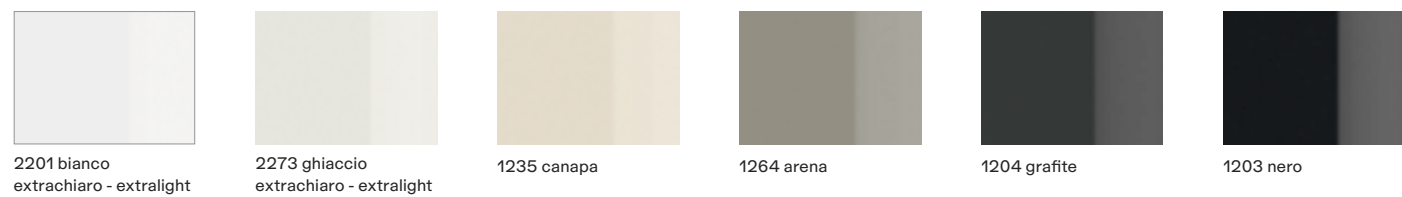

Essenze
Woods

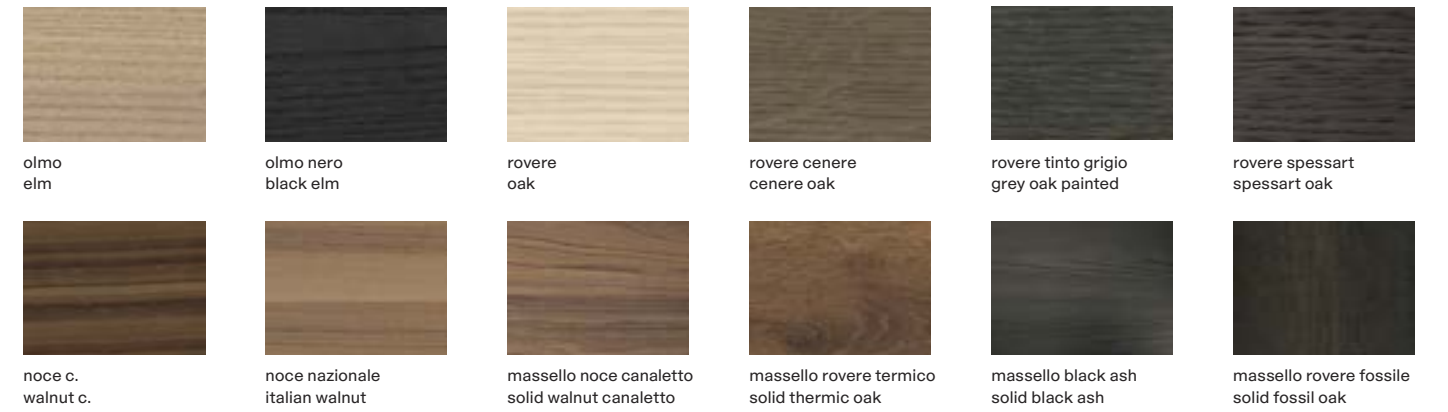

Nobilitato
Melamine



Nobilitato silk
Silk melamine



Laminato opaco
Mat laminate

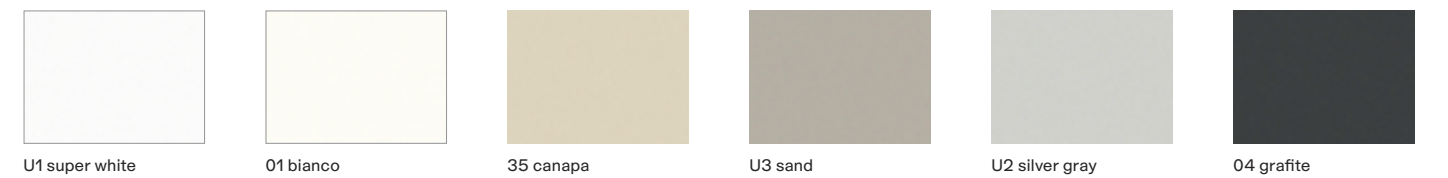

Laminato opaco touch
Mat laminate touch

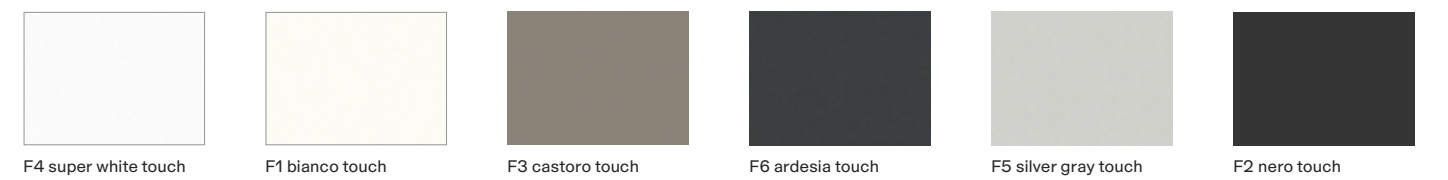

FINITURE
FINISHINGS

Quarzite lucida
Glossy composite stone

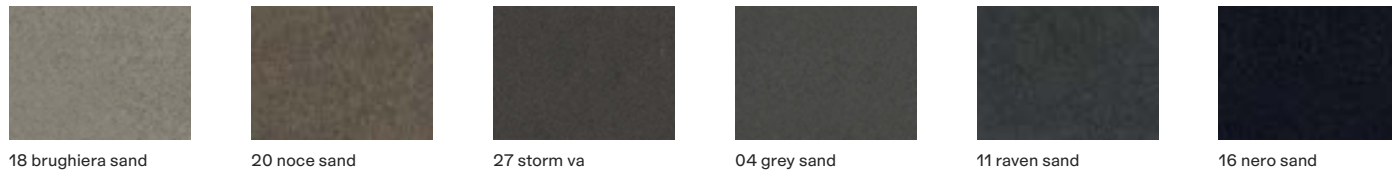

Quarzite micropallinata
Micro-blasted composite stone

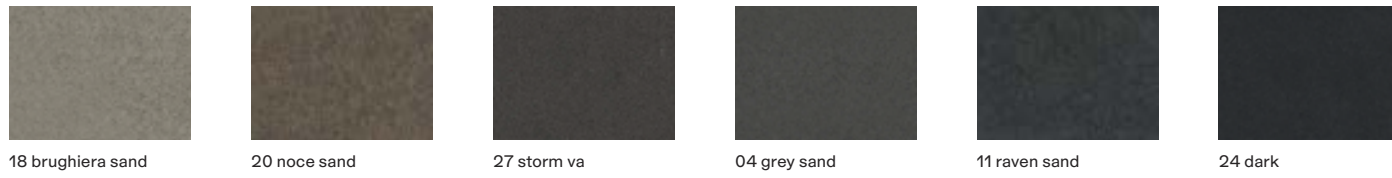

Marmo levigato
Mat marble

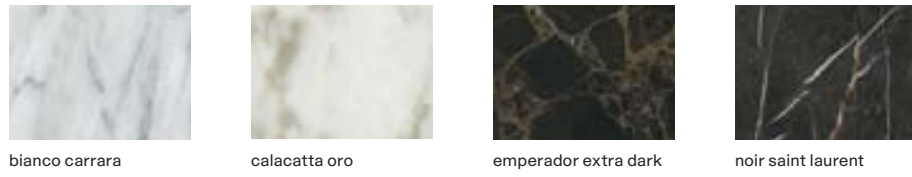

Marmo lucido
Glossy marble

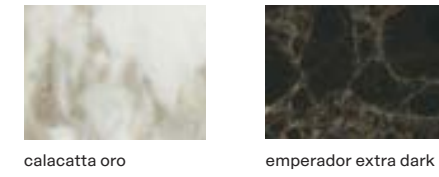

Pietra
Stone



Inalco MDi®
Inalco MDi®

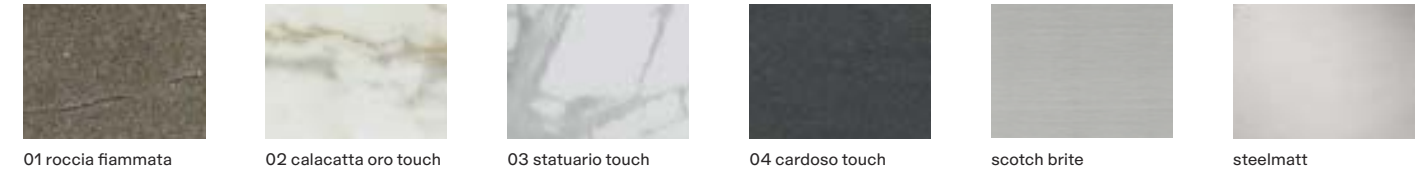

Dekton
Dekton



DuPont Corian®
DuPont Corian®

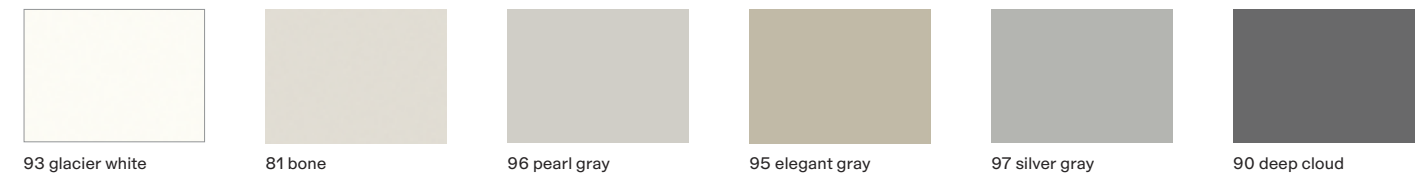

Laminato tuttocolore
Tuttocolore laminato

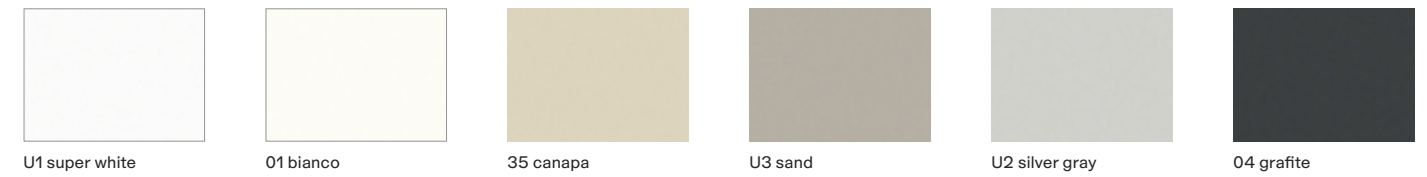

Laminato tuttocolore touch
Tuttocolore laminate touch

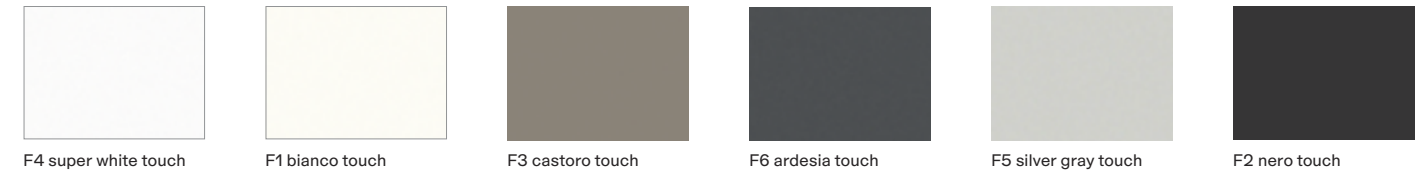

Acciaio
Steel

Poliform Spa
via Montesanto 28
Casella postale n. 1
22044 Inverigo (CO) Italy
t +39 031 6951
f +39 031 699444
info@poliform.it
poliform.it



Poliform realizza tutte le sue collezioni in Italia usando componenti e materie prime selezionate.

All the Poliform collections are manufactured 100% in Italy using top-class components and materials.

Poliform si riserva il diritto di apportare, senza preavviso, ogni modifica mirata al miglioramento funzionale e qualitativo dei propri prodotti. Testi e disegni presenti in questo stampato hanno scopo divulgativo: per ogni aspetto tecnico e dimensionale fare riferimento ai listini aziendali e relativi aggiornamenti. I campioni di colori e materiali hanno valore indicativo.

Poliform reserves the rights at all time to apply modifications for the functional or qualitative improvement of its products. Texts and drawings present in this brochure have a divulgative purpose: for every technical and dimensional aspect please refer to the company's price lists and their relative updatings. The colour and material samples have an indicative value.

Creative Direction
Apartamento Studios

Graphic Design
Apartamento Studios

Interiors Photography
Federico Cedrone, Omar Sartor

Still Life Photography
Silvia Orlandi

Interiors Styling
Poliform Lab

1st edition October 2019
cod. K50/R1/2019



TWO THOUSAND NINETEEN