

NIGHT COMPLEMENTS
2022

Poliform

Poliform

Poliform presenta la collezione di letti, complementi e accessori per la zona notte. Arredi che uniscono eleganza e comfort, pensati per rendere personali ed esclusivi gli spazi dedicati all'intimità e alla quiete. Letti che invitano al relax e assicurano la massima qualità del riposo. Comodini e cassettiere in cui funzionalità ed estetica trovano il perfetto equilibrio. Materiali, lavorazioni e dettagli richiamano quelli della zona giorno, creando continuità tra le aree della casa – in puro stile Poliform.

Poliform presents the collection of beds, complements, and accessories for the night area. Furnishings that combine elegance and comfort, designed to make the spaces dedicated to intimacy and tranquillity personal and exclusive. Beds that invite you to relax and ensure maximum quality of rest. Night tables and chest of drawers where functionality and aesthetics find the perfect balance. Materials and details reference those of the day area, creating continuity among the areas of the house – in pure Poliform style.

COLLECTIONS

LETTI BEDS	7
CONTENITORI STORAGE UNITS	167
SPECCHIERE MIRRORS	271
ACCESSORI LETTO BED ACCESSORIES	315

BEDS

Offrire la migliore esperienza del riposo, sempre: questa è la filosofia che ispira la collezione di letti Poliform. Carlo Colombo, Rodolfo Dordoni, Emmanuel Gallina, Jean-Marie Massaud, Paolo Piva e Marcel Wanders studio danno ciascuno la propria interpretazione del letto, tra classicità ed eleganza. Il risultato è una serie di proposte dal design riconoscibile e contemporaneo, che sperimenta nuove ampiezze e profondità, gioca con l'idea di morbidezza e abbondanza e conquista per lo stile e la personalità.

Offering the best rest experience, always: this is the philosophy that inspires the Poliform collection of beds. Carlo Colombo, Rodolfo Dordoni, Emmanuel Gallina, Jean-Marie Massaud, Paolo Piva, and Marcel Wanders studio each give their own interpretation of the bed, between classicism and elegance. The result is a series of offers with a recognizable and contemporary design, which experiments with new widths and depths, plays with the idea of softness and abundance, and captivates with style and personality.

BEDS

GENTLEMAN	11
KELLY	27
PARK 1	47
REVER	63
DREAM	77
JACQUELINE	97
CHLOE	121
ARCA	135
ONDA	151

GENTLEMAN

Il letto Gentleman s'ispira alla collezione giorno sia nel mood, che richiama la nobiltà d'animo e la ricercatezza estetica proprie del gentiluomo, sia nei dettagli. La testiera è ampia e avvolgente come l'alto poggiatesta della poltrona. Il letto appoggia su piedini sottili dal portamento elegante, tratto distintivo della serie.

The Gentleman bed echoes the mood and appearance of the living room collection, inspired by the nobility of spirit and aesthetic refinement of the gentleman. The headboard is wide and enveloping, like the raised headrest of the armchair. The bed rests on slender feet with an elegant posture, the distinctive feature of the series.







Qui, nelle pagine precedenti e in chiusura: letto Gentleman, testata e base imbottite con rivestimento sfoderabile in tessuto Agadir 05 crema e bordura gros-grain nero, piedini e profilo in brown nickel lucido. Rulli in pelle sfoderabile Nabuk 04 moka. Biancheria da letto coordinata in cotone Provence 08 polvere e 04 tortora. Comodino Gentleman in olmo nero con top in laccato opaco bronzo e piedini brown nickel lucido. Dietro al letto, mensolone sospeso retroilluminato Code in olmo nero. Poltrona Gentleman Relax in tessuto sfoderabile Siro 02 lino e basamento brown nickel lucido. Pouf Saint-Germain in pelle sfoderabile Nabuk 06 mastice, piedini brown nickel opaco. Boiserie Code in tessuto lino bruciato e profili champagne opaco. Armadio Senzafine Cover con ante battenti in tessuto lino bruciato e profili champagne opaco. Tappeto Cannelé.

This, previous pages and closing page: Gentleman bed, padded headboard and base with removable cover in fabric Agadir 05 crema and border in grosgrain nero, feet and profile in glossy brown nickel. Roll cushions in removable leather Nabuk 04 moka. Coordinated bed linen in cotton Provence 08 polvere and 04 tortora. Gentleman night table in black elm with top in mat lacquer bronzo and glossy brown nickel feet. Behind the bed, Code backlit thick shelf in black elm. Gentleman Relax armchair in removable fabric Siro 02 lino and glossy brown nickel base. Saint-Germain pouf in removable leather Nabuk 06 mastice, mat brown nickel feet. Code wall panelling in fabric lino bruciato with mat champagne profiles. Wardrobe Senzafine Cover with leaf doors in fabric lino bruciato and mat champagne profiles. Carpet Cannelé.







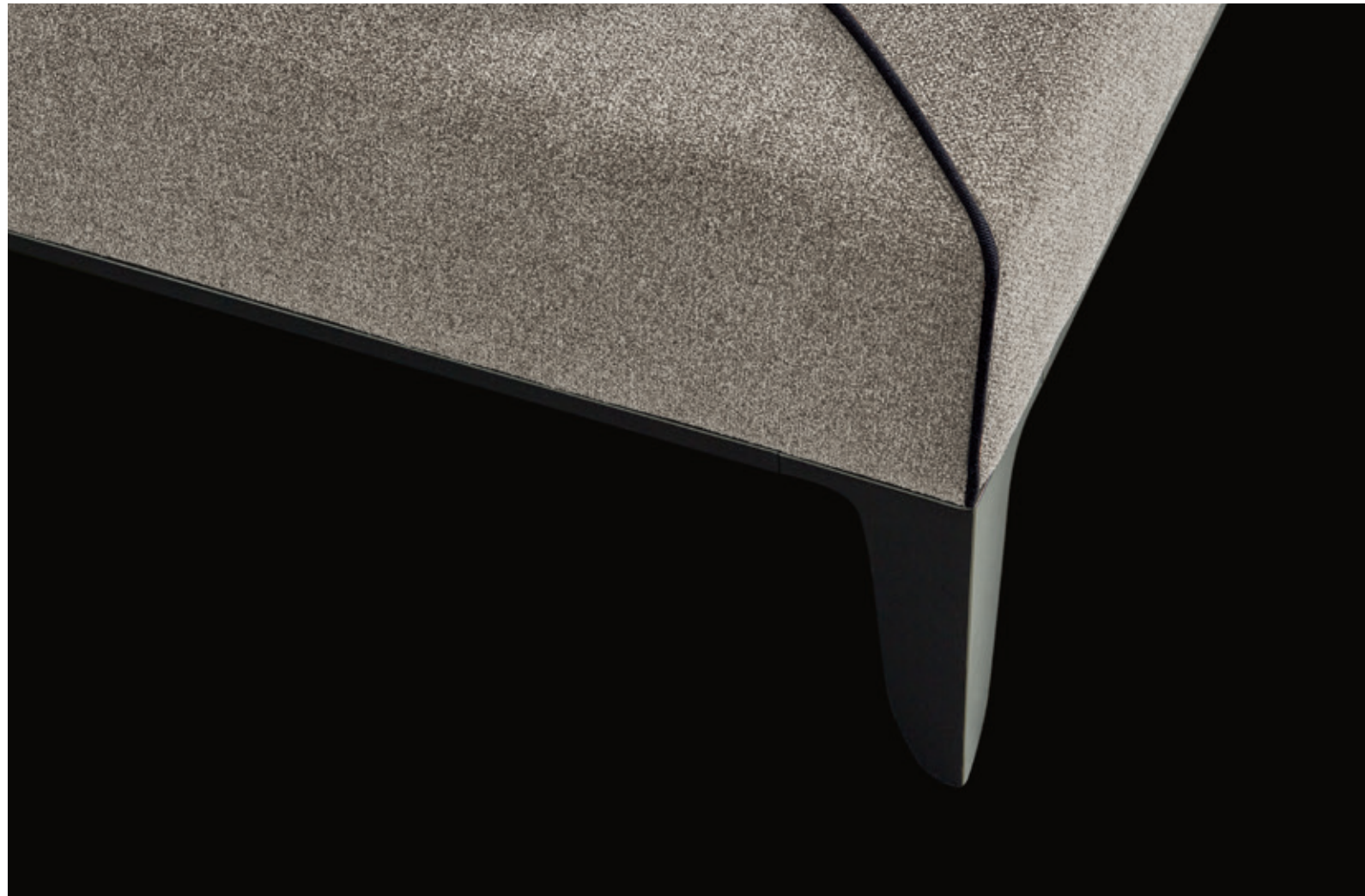

Qui e nella pagina precedente: letto Gentleman, testata e base imbottite con rivestimento sfoderabile in tessuto Naxos 17 corda e bordura gros-grain nero, piedini e profilo in brown nickel lucido. Rulli in pelle sfoderabile Nabuk 04 moka. Biancheria da letto coordinata in cotone Provence 02 panna con profilo panna e 03 ghiaccio con profilo ghiaccio. Coperta Linus notte.

This and previous page: Gentleman bed, padded headboard and base with removable cover in fabric Naxos 17 corda and border in grosgrain nero, feet and profile in glossy brown nickel. Roll cushions in removable leather Nabuk 04 moka. Coordinated bed linen in cotton Provence 02 panna with profile in panna and 03 ghiaccio with profile in ghiaccio. Blanket Linus notte.

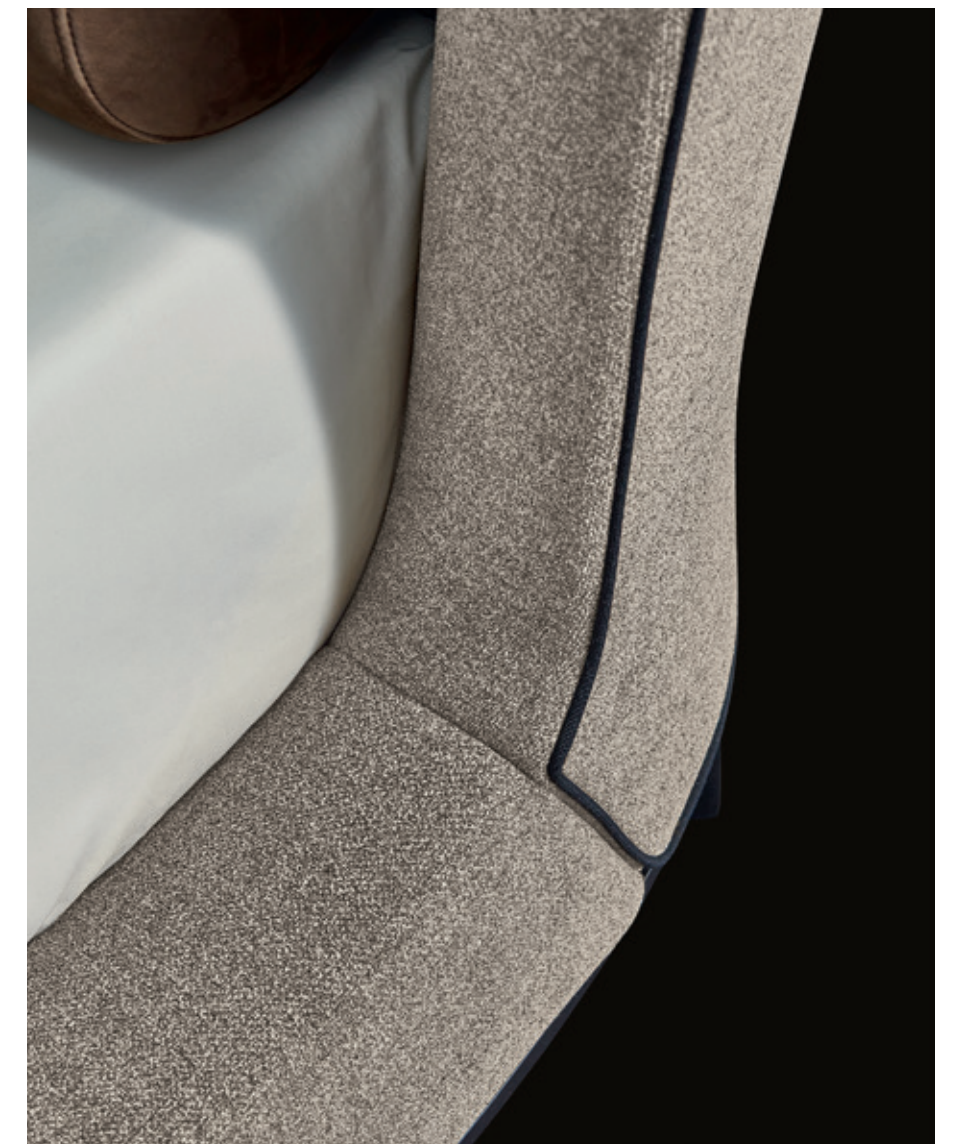



GENTLEMAN

Design Marcel Wanders studio, 2020

Letto con testata imbottita in poliuretano flessibile stampato e prerivestimento in fibra di poliestere.

Base letto in legno massello con imbottitura in poliuretano flessibile e prerivestimento in fibra di poliestere.

Rivestimento sfoderabile in tessuto o pelle. Bordura gros-grain nei colori da campionario. Piedini e profilo in metallo verniciato champagne opaco, brown nickel opaco o lucido.

Coppia rulli opzionale con rivestimento sfoderabile in tessuto o pelle.

Predisposto per materassi:

l 1600-1800 x p 2000-2100

Tipologia di rete:

- rete fissa
- reti anatomiche

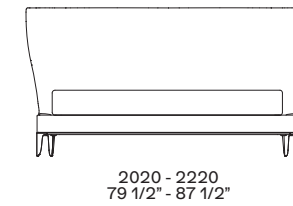

Bed with padded headboard in moulded flexible polyurethane and pre-covering in polyester fibre.

Bed frame in solid wood with padding in flexible polyurethane and pre-covering in polyester fibre.

Removable covering in fabric or leather. Gros-grain piping in the sample colours. Feet and profile in metal mat painted champagne, mat or glossy brown nickel.

Optional pair of roll cushions with removable fabric or leather covering.

For mattresses:

w 63"-70 3/4" x d 78 3/4"-82 3/4"

Bedstead type:

- fixed bedstead
- anatomic bedsteads

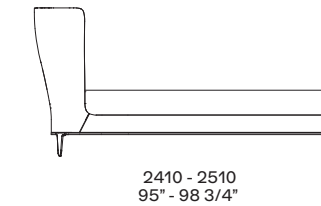



KELLY

L'armonica combinazione di finiture diverse caratterizza il letto Kelly, disegnato da Emmanuel Gallina. La base in legno massello, disponibile anche rivestita in tessuto o pelle, è slanciata e leggera mentre il giroletto imbottito, in tessuto o pelle come la testata, rende il letto accogliente. Preziosa e romantica la testata nella variante con interno in pelle intrecciata, una lavorazione che per artigianalità ed eleganza è affine all'estetica della moda.

The harmonious combination of different finishes characterizes the Kelly bed, designed by Emmanuel Gallina. The solid wood base, also available upholstered in fabric or leather, is slender and light, while the upholstered bed frame, in fabric or leather like the headboard, makes the bed cosy. Precious and romantic is the headboard in the variant with interwoven leather interior, a detail that, for craftsmanship and elegance, is akin to fashion aesthetics.





Qui e nelle pagine precedenti: letto Kelly, testata imbottita con rivestimento sfoderabile, esterno in pelle Nabuk 02 tortora, interno in pelle Nabuk intrecciata 02 tortora. Base letto in rovere spessart e parte interna con rivestimento non sfoderabile in pelle Nabuk 02 tortora. Biancheria da letto coordinata in cotone Provence 08 polvere con profili bianco e polvere. Coperta Linus granata. Comodini Kelly in rovere spessart con top laccato lucido caramello e piedini in brown nickel lucido. Poltrona e panca Jane in tessuto sfoderabile Rabat 402 pernice, base in glossy brown nickel. Armadio Senzafine Bangkok in cuoio 28 avorio e Quid integrato con boiserie in olmo nero. Tappeto Soft.

This and previous pages: Kelly bed, padded headboard with removable covering, outer part in leather Nabuk 02 tortora, inner part in woven leather Nabuk 02 tortora. Bed frame in spessart oak and inner part with non-removable covering in leather Nabuk 02 tortora. Coordinated bed linen in cotton Provence 08 polvere with profiles in bianco and polvere. Blanket Linus granata. Kelly night tables in spessart oak with caramello glossy lacquered top and feet in glossy brown nickel. Jane armchair and bench in removable fabric Rabat 402 pernice, base in glossy brown nickel. Senzafine Bangkok wardrobe in hide 28 avorio and integrated Quid with wall panelling in black elm. Carpet Soft.





Qui e nella pagina precedente: letto Kelly, testata imbottita con rivestimento sfoderabile, esterno testata e rulli in pelle Silk 12 senape, interno testata in tessuto Arcadia 05 bronzo. Base letto in noce gold e parte interna con rivestimento non sfoderabile in pelle Silk 12 senape. Biancheria da letto coordinata in cotone Provence 01 bianco e 07 grafite con profili nero. Nella pagina successiva: letto Kelly, testata e base imbottite con rivestimento sfoderabile in tessuto Naxos 27 prussia, interno testata in tessuto Kitami 11 oceano. Rulli in tessuto sfoderabile Naxos 27 prussia. Biancheria da letto coordinata in cotone Provence 01 bianco con profilo nero e 08 polvere con profilo polvere. Coperta Linus grafite.

This and previous page: Kelly bed, padded headboard with removable covering, outer headboard and roll cushions in leather Silk 12 senape, inner headboard in fabric Arcadia 05 bronzo. Bed frame in gold walnut and inner part with non-removable covering in leather Silk 12 senape. Coordinated bed linen in cotton Provence 01 bianco and 07 grafite with profiles in nero. Next page: Kelly bed, padded headboard and bed frame with removable covering in fabric Naxos 27 prussia, inner headboard in fabric Kitami 11 oceano. Roll cushions in removable fabric Naxos 27 prussia. Coordinated bed linen in cotton Provence 01 bianco with profile in nero and 08 polvere with profile in polvere. Blanket Linus grafite.

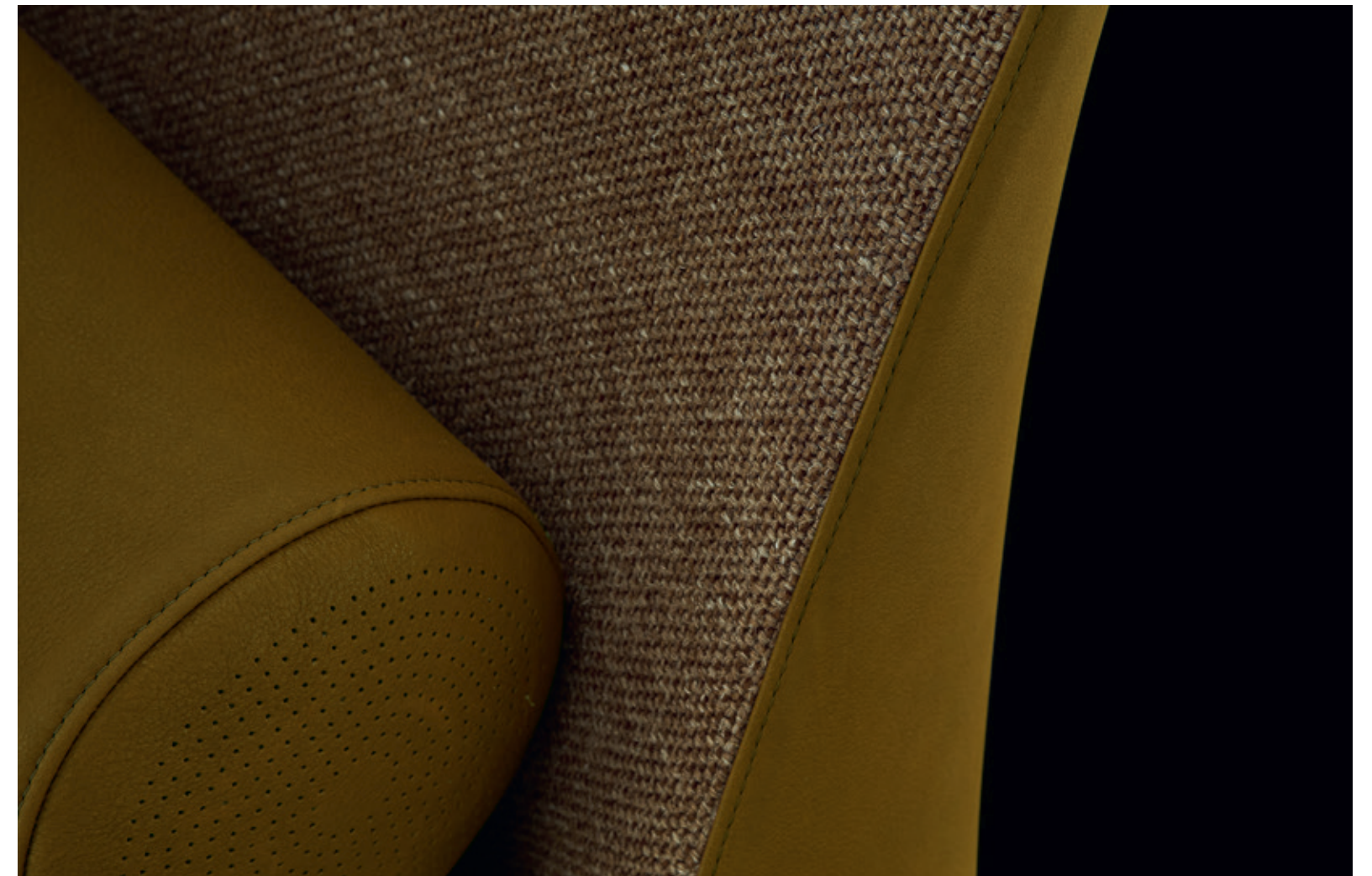
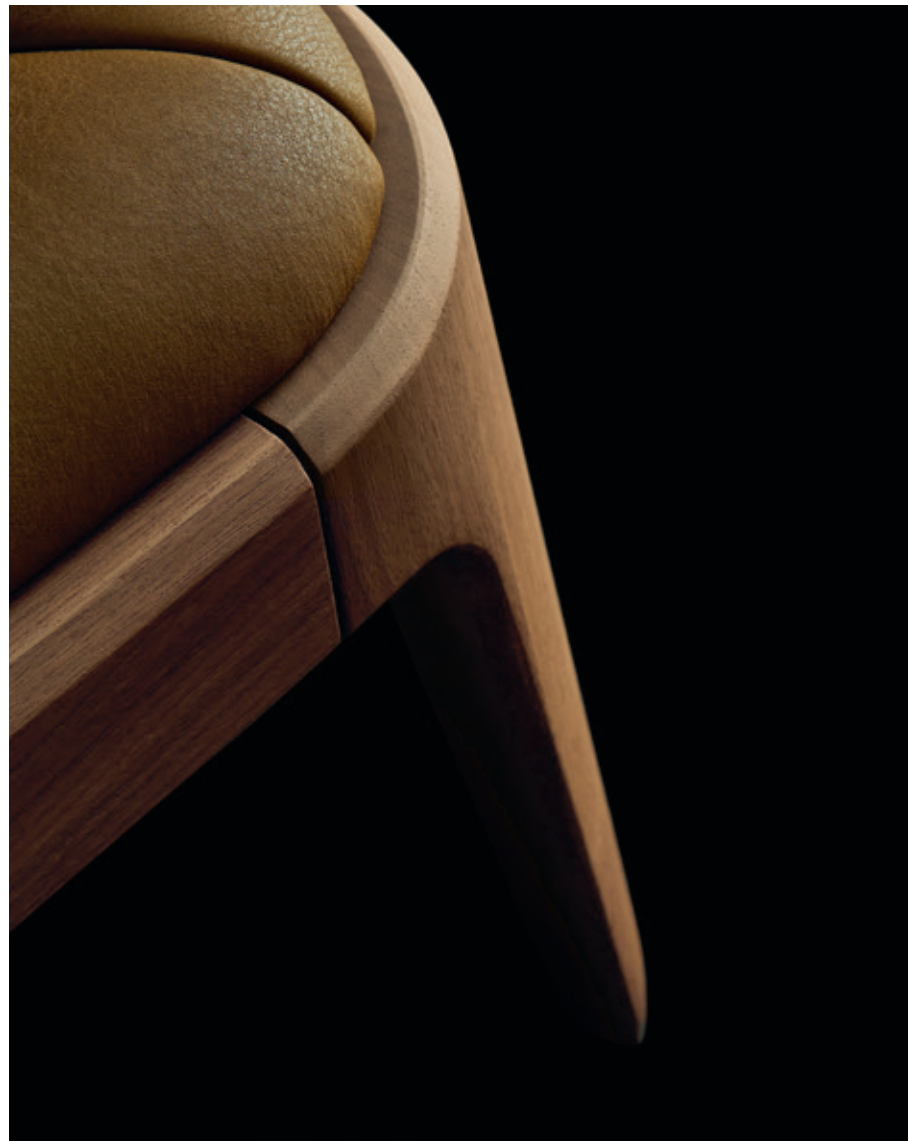





Qui, nella pagina precedente e nella successiva: letto Kelly, testata e base imbottite con rivestimento sfoderabile in tessuto Naxos 16 sabbia, interno testata in tessuto Sendai 01 cenere. Biancheria da letto coordinata in cotone Provence 01 bianco con profilo polvere e 08 polvere con profilo bianco. Coperta Linus latte. Comodino Kelly in olmo nero con top in cuoio 26 invecchiato. Poltrone e pouf Jane Large in pelle non sfoderabile Nabuk 09 ruggine e basamento in olmo nero. Composizione Quid con bacheche a giorno, struttura in olmo nero e schienali in laccato lucido corda, ripiani in olmo nero e vetro trasparente extrachiaro. Pouf Play in tessuto sfoderabile Sendai 02 tortora.

This, previous page and next page: Kelly bed, padded headboard and bed frame with removable covering in fabric Naxos 16 sabbia, inner headboard in fabric Sendai 01 cenere. Coordinated bed linen in cotton Provence 01 bianco with profile in polvere and Provence 08 polvere with profile in bianco. Blanket Linus latte. Kelly night table in black elm with top in hide 26 invecchiato. Jane armchair and pouf in non-removable leather Nabuk 09 ruggine and base in black elm. Quid composition with open display cases, structure in black elm and backs in glossy lacquer corda, shelves in black elm and extra light transparent glass. Play pouf in removable fabric Sendai 02 tortora.





KELLY

Design Emmanuel Gallina, 2016

Letto con testata imbottita in poliuretano flessibile stampato con prerivestimento in fibra di poliestere e rivestimento sfoderabile in tessuto o pelle. Possibilità di rivestimento diverso tra interno ed esterno della testata, rivestimento sfoderabile ma non lavabile se il tessuto viene abbinato a una pelle.

Base letto legno, massello nella finitura noce gold, rovere spessart e olmo nero con imbottitura nella parte superiore in poliuretano flessibile e rivestimento non sfoderabile in tessuto o pelle.

Base letto rivestita, legno massello con imbottitura in poliuretano flessibile, piedi in poliuretano compatto, prerivestimento in fibra di poliestere e rivestimento sfoderabile in tessuto o pelle.

Coppia rulli opzionale con rivestimento sfoderabile in tessuto o pelle.

Predisposto per materassi:

l 1600-1800 x p 2000

Queen size letto l 1694 x p 2332

materasso l 1525 x p 2030

King size letto l 2100 x p 2332

materasso l 1930 x p 2030

Tipologia di rete:

rete fissa ridotta

Bed with padded headboard in moulded flexible polyurethane with pre-covering in polyester fibre and removable cover in fabric or leather. Possibility for different type of covering on inner and outer part of headboard, the cover is removable but not washable in case of combination of fabric and leather.

Wooden bed frame in solid wood in the finish gold walnut, spessart oak and black elm with padding in the upper part in flexible polyurethane and non-removable covering in fabric or leather. Covered bed frame in solid wood with padding in flexible polyurethane, feet in compact polyurethane, pre-covering in polyester fibre, removable covering in fabric or leather.

Optional pair of roll cushions with removable fabric or leather covering.

For mattresses:

w 63"- 70 3/4" x d 78 3/4"

Queen size bed w 66 3/4" x d 91 3/4"

for mattress w 60" x d 80"

King size bed w 82 3/4" x d 91 3/4"

for mattress w 76" x d 80"

Bedstead type:

customized fixed bedstead

Base legno Wooden bed frame

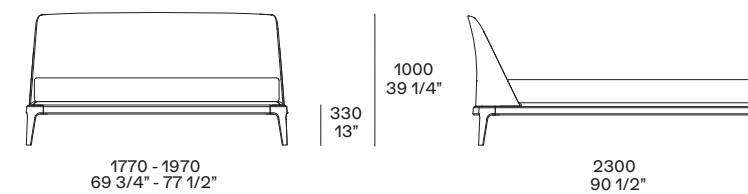

Base rivestita Covered bed frame

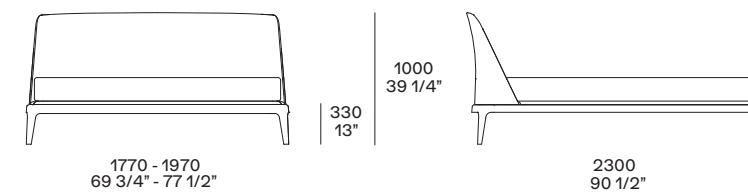

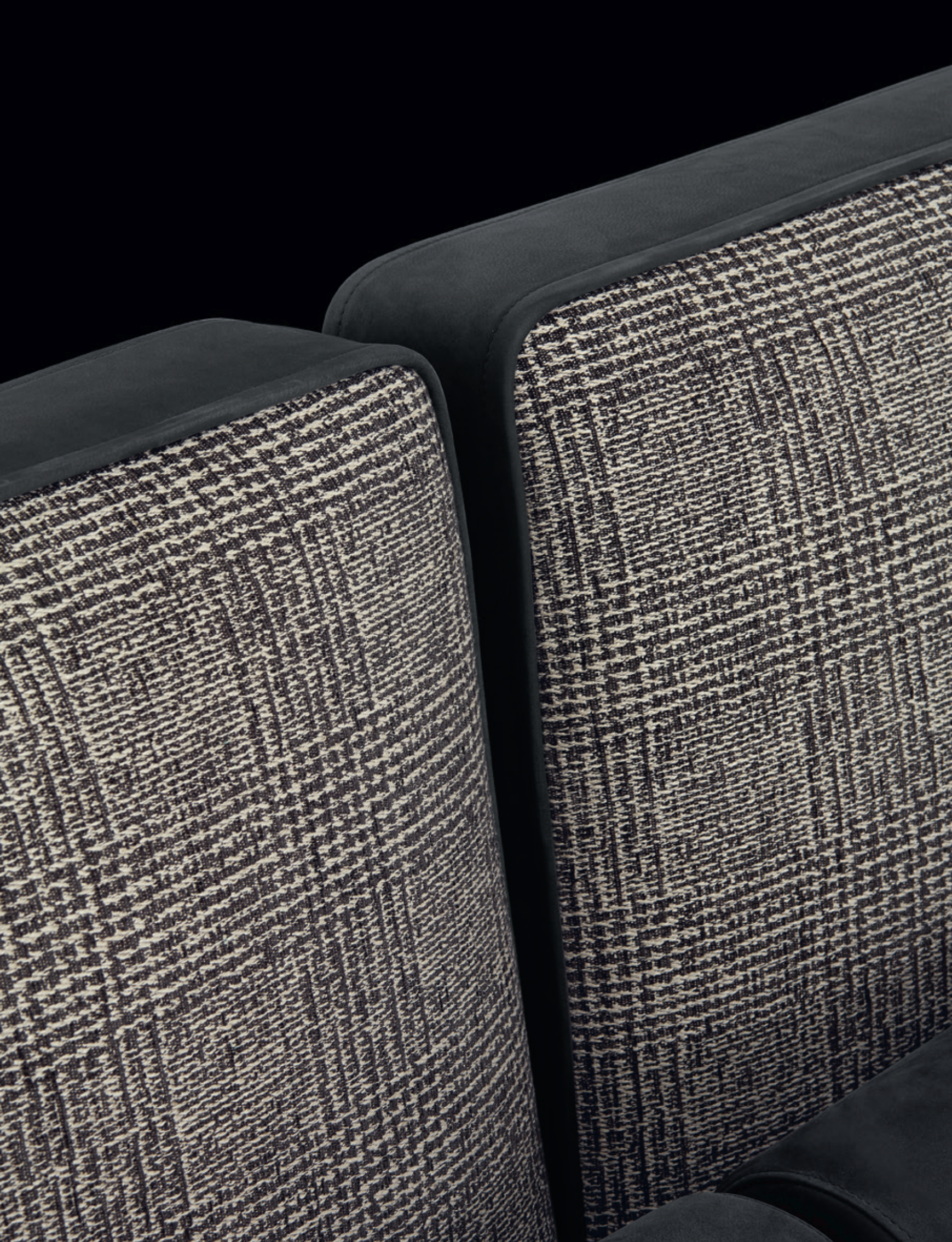

PARK 1

Carlo Colombo firma un letto che unisce alle proporzioni generose della testata la leggerezza dei piedini e del giroletto in metallo rivestito in pelle. La testata, morbida e piena, è costituita da due maxi cuscini. Profili e retro sono disponibili anche in pelle.

Carlo Colombo designs a bed that combines the generous proportions of the headboard with the lightness of the feet and of the metal bed frame covered in leather. The headboard, soft and full, consists of two maxi cushions. Profiles and back are also available in leather.







Qui, nelle pagine precedenti e in chiusura: letto Park 1, testata imbottita con rivestimento sfoderabile, esterno in pelle Soft 14 oliva e interno in tessuto Nayoro 02 sabbia. Base letto in brown nickel opaco e pelle sfoderabile Soft 14 oliva. Biancheria da letto coordinata in cotone Provence 03 ghiaccio con profilo roccia e 06 roccia con profilo ghiaccio. Panca Park, seduta con rivestimento sfoderabile in pelle Soft 14 oliva, struttura in brown nickel opaco e pelle sfoderabile Soft 14 oliva. Comodini Abbinabili in rovere spessart. Tavolini Soori in metallo finitura bronzo anticato. Poltrone Stanford con rivestimento non sfoderabile in tessuto Orleans 12 carbone, basamento girevole in brown nickel lucido.

This, previous pages and closing page: Park 1 bed, padded headboard with removable covering, outer part in leather Soft 14 oliva and inner part in fabric Nayoro 02 sabbia. Bed frame in mat brown nickel and removable leather Soft 14 oliva. Coordinated bed linen in cotton Provence 03 ghiaccio with profile in roccia and 06 roccia with profile in ghiaccio. Park bench, seat with removable covering in leather Soft 14 oliva, structure in mat brown nickel and removable leather Soft 14 oliva. Abbinabili night tables in spessart oak. Soori coffee tables in antique bronze finished metal. Stanford armchairs with non-removable covering in fabric Orleans 12 carbone, swivel base in glossy brown nickel.





Qui e nella pagina precedente: letto Park 1, testata imbottita con rivestimento sfoderabile, esterno in pelle Nabuk 05 grafite e interno in tessuto Sendai 03 fango. Base letto in brown nickel opaco e tessuto Sendai 03 fango. Base letto in brown nickel opaco e tessuto Sendai 03 fango. Rulli in pelle sfoderabile Nabuk 05 grafite. Biancheria da letto coordinata in cotone Provence 01 bianco e 03 ghiaccio con profili nero. Coperta Linus grafite.

This and previous page: Park 1 bed, padded headboard with removable covering, outer part in leather Nabuk 05 grafite and inner part in fabric Sendai 03 fango. Bed frame in mat brown nickel and removable fabric Sendai 03 fango. Roll cushions in removable leather Nabuk 05 grafite. Coordinated bed linen in cotton Provence 01 bianco and 03 ghiaccio with profiles in nero. Blanket Linus grafite.



In questa pagina: panca Park, seduta con rivestimento sfoderabile in tessuto Arcadia 12 polvere, struttura in brown nickel lucido.

This page: Park bench, seat with removable covering in fabric Arcadia 12 polvere, structure in glossy brown nickel.





PARK 1
Design Carlo Colombo, 2018

Letto con testata imbottita in poliuretano flessibile stampato con prerivestimento in fibra di poliestere e rivestimento sfoderabile in tessuto o pelle. Possibilità di rivestimento diverso tra interno ed esterno della testata (incluse fasce laterali), rivestimento sfoderabile ma non lavabile se il tessuto viene abbinato a una pelle.
Base letto (e panca) verniciata in alluminio verniciato brown nickel opaco o lucido.
Base letto (e panca) rivestita in alluminio con prerivestimento in fibra di poliestere e rivestimento sfoderabile in tessuto o pelle, piedini brown nickel opaco o lucido.
Panca Park con seduta in legno e derivati, imbottitura in poliuretano espanso a quote differenziate e rivestimento sfoderabile in tessuto o pelle.
Coppia rulli opzionale con rivestimento sfoderabile in tessuto o pelle.

Bed with padded headboard in moulded flexible polyurethane foam with pre-covering in polyester fibre and removable fabric or leather covering. Possibility for different type of covering on inner and outer part of headboard (including side bands), the cover is removable but not washable in case of combination of fabric and leather.
Painted bed frame (and bench) in mat or glossy brown nickel painted aluminium.
Covered bed frame (and bench) in aluminium with pre-covering in polyester fibre and removable fabric or leather covering, mat or glossy brown nickel feet.
Park bench with seat in wood and wood by-products, padding in multi-density expanded polyurethane and removable covering in fabric or leather.
Optional pair of roll cushions with removable fabric or leather covering.

Predisposto per materassi:
l 1600-1800 x p 2000

For mattresses:
w 63"- 70 3/4" x d 78 3/4"

Tipologia di rete:
rete fissa ridotta

Bedstead type:
customized fixed bedstead

Base verniciata
Painted bed frame

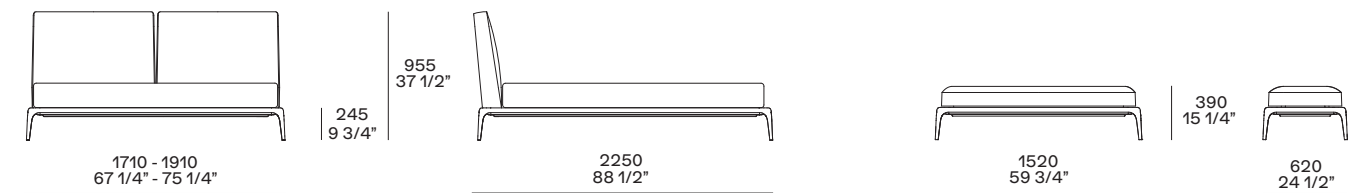

Base rivestita
Covered bed frame

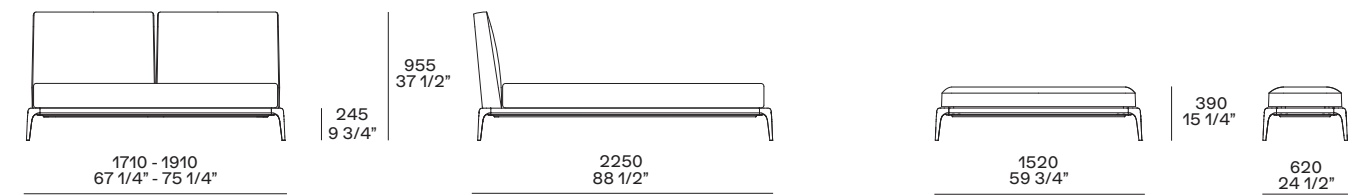

REVER

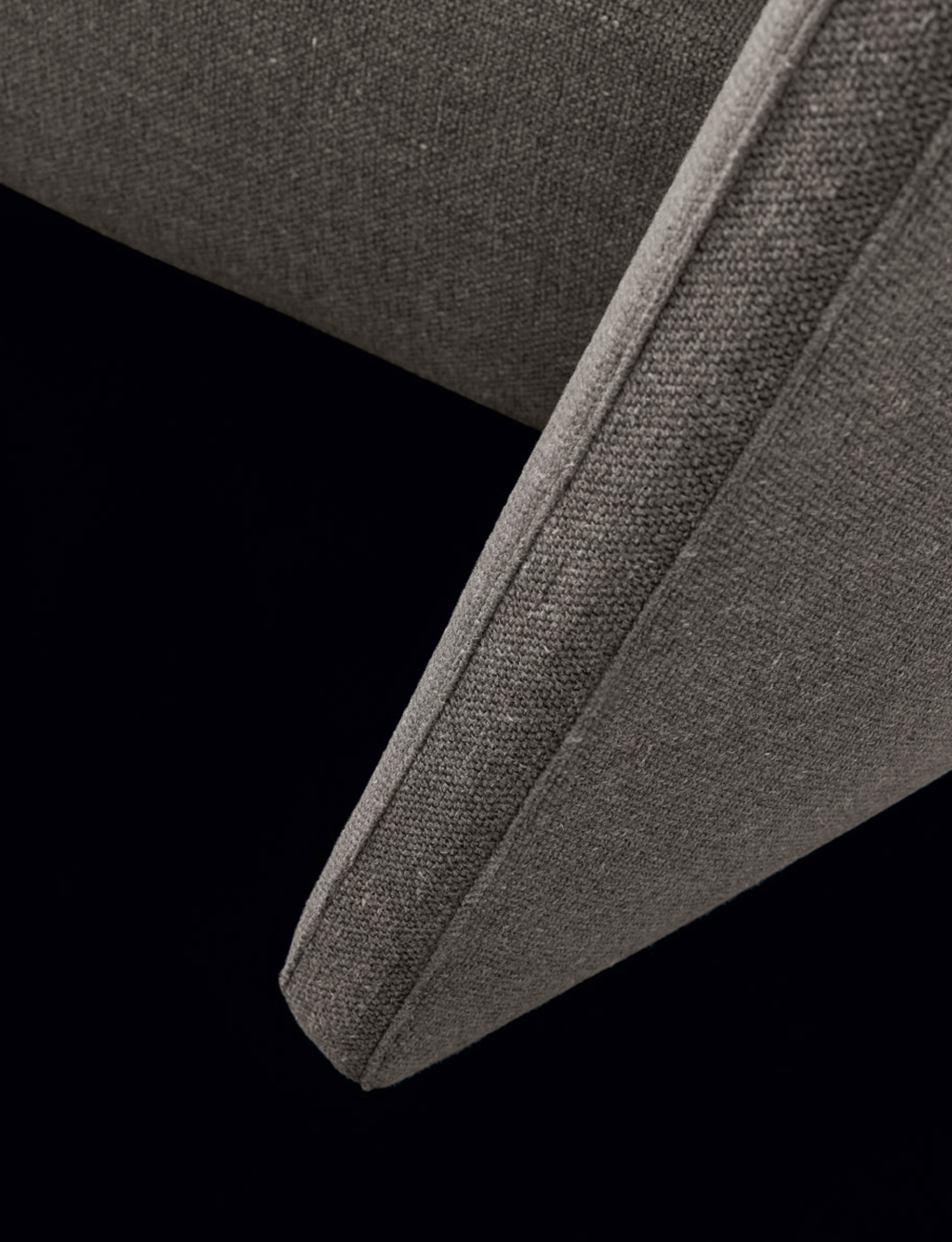

Proporzioni generose per un letto elegante e avvolgente, come il revers di una giacca da uomo. Progettato da Rodolfo Dordoni per diventare protagonista della camera da letto, dove dà il meglio di sé posizionato a centro stanza, si riconosce per la testata leggermente inclinata e la sofisticata lavorazione effetto capitoné dell'interno.

Generous proportions for an elegant and enveloping bed, like the revers of a men's jacket. Designed by Rodolfo Dordoni to become the protagonist of the bedroom, where it gives its best positioned in the centre of the room; it is recognizable by the slightly inclined headboard and the sophisticated capitoné effect detail of the interior.







Qui, nelle pagine precedenti e in chiusura: letto Rever, testata e base imbottite con rivestimento sfoderabile in tessuto Orleans 05 pernice, fasce perimetrali testata, fasce interne base letto e rulli in pelle Nabuk 01 latte. Biancheria da letto coordinata in cotone Provence 01 bianco e 08 polvere con profili nero. Tavolini Soori in metallo finitura bronzo antico. Panca Home Hotel in olmo nero.

This, previous pages and closing page: Rever bed, padded headboard and bed frame with removable covering in fabric Orleans 05 pernice, perimetric headboard bands, bed frame inner bands and roll cushions in leather Nabuk 01 latte. Coordinated bed linen in cotton Provence 01 bianco and 08 polvere with profiles in nero. Soori coffee tables in antique bronze finished metal. Home Hotel bench in black elm.





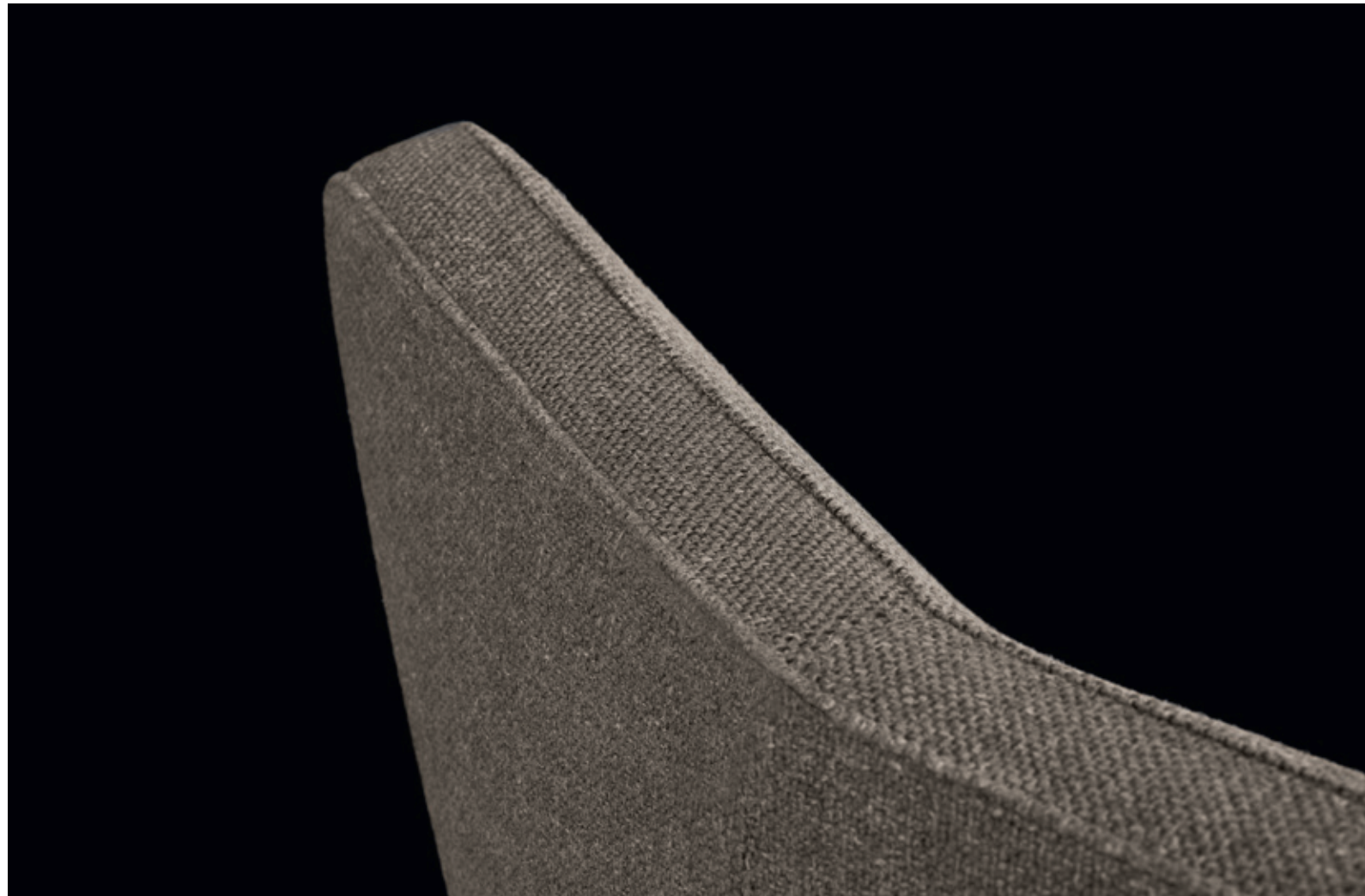

Qui e nella pagina precedente: letto Rever, testata e base imbottite con rivestimento sfoderabile in tessuto Arcadia 06 tortora. Rulli in pelle sfoderabile Soft 02 mastice. Biancheria da letto coordinata in cotone Provence 01 bianco e 07 grafite con profili nero. Coperta Linus latte.

This and previous page: Rever bed, padded headboard and bed frame with removable covering in fabric Arcadia 06 tortora. Roll cushions in removable leather Soft 02 mastice. Coordinated bed linen in cotton Provence 01 bianco and 07 grafite with profiles in nero. Blanket Linus latte.





REVER

Design Rodolfo Dordoni, 2016

Letto con testata imbottita in poliuretano flessibile stampato con prerivestimento in fibra di poliestere e rivestimento sfoderabile in tessuto o pelle. La parte frontale della testata presenta delle impunture con cucitura a cordoncino a leggero contrasto di colore.

Base letto imbottita, pannello di particelle di legno, imbottitura in poliuretano flessibile con prerivestimento in fibra di poliestere e rivestimento sfoderabile in tessuto o pelle. Possibilità testata con fasce perimetrali e base letto con fasce interne in pelle in abbinamento a un tessuto. In questa versione il rivestimento sarà sfoderabile ma non lavabile.

Coppia rulli opzionale con rivestimento sfoderabile in tessuto o pelle.

Predisposto per materassi:

l 1800-2000 x p 2000-2100

King size letto l 2815 x p 2430
materasso l 1930 x p 2030

Tipologia di rete:

- rete fissa
- reti anatomiche
- contenitore con rete ribaltabile

Bed with padded headboard in moulded flexible polyurethane foam with pre-covering in polyester fibre and removable fabric or leather covering. The front part of the headboard features cord stitching with a light contrasting colour.

Padded bed frame, wood particle board, padding in flexible polyurethane with pre-covering in polyester fibre and removable fabric or leather covering. Possibility of perimeter bands for the headboard and bed base with inner bands in leather in matching colour with the fabric. In this version the covering is removable but not washable.

Optional pair of roll cushions with removable fabric or leather covering.

For mattresses:

w 70 3/4"-78 3/4" x d 78 3/4"-82 3/4"

King size bed w 110 3/4" x d 95 3/4"
for mattress w 76" x d 80"

Bedstead type:

- fixed bedstead
- anatomic bedsteads
- container box with tip-up bedstead

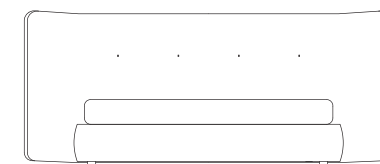

1975 - 2175
77 3/4" - 85 3/4"

2685 - 2885
105 3/4" - 113 1/2"

300
11 3/4"

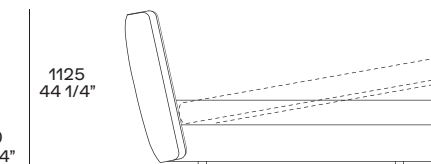

1125
44 1/4"

2395 - 2495
94 1/4" - 98 1/4"

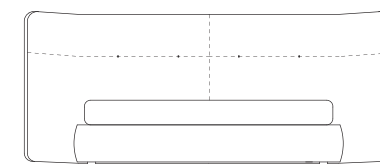

cuciture testata versione in pelle
headboard stitching leather version

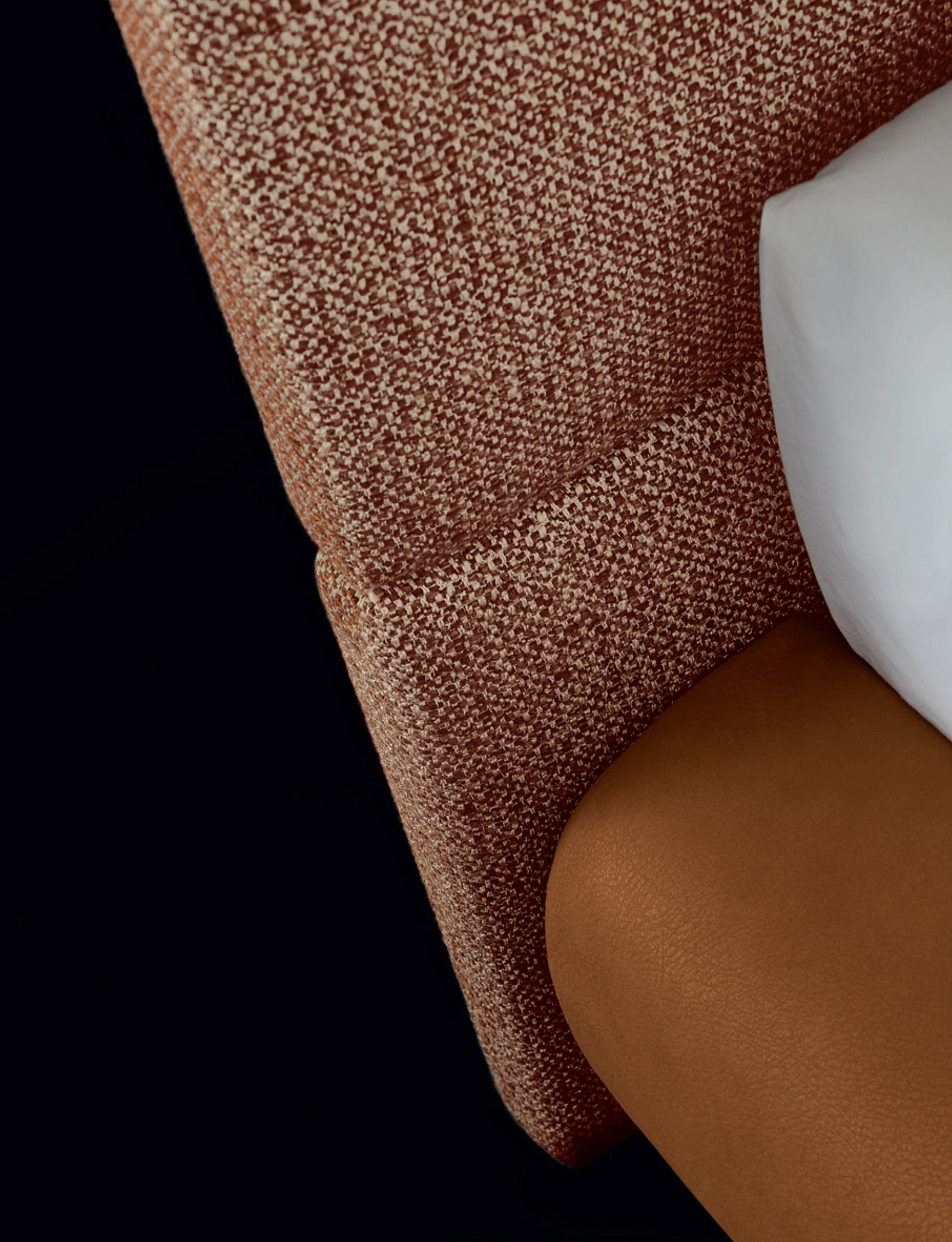

DREAM

Marcel Wanders studio disegna un letto da sogno, accostando a una base dalle linee arrotondate ed essenziali un sistema di pannelli imbottiti completamente personalizzabile. Il letto Dream è disponibile con o senza testata imbottita, oppure con pannellatura a muro, dove i pannelli rivestiti singolarmente in tessuto o pelle fungono al contempo da testata e da boiserie.

Marcel Wanders studio designs a dream bed, combining a base with rounded and minimalistic lines with a completely customisable system of cushioned panels. The Dream bed is available with or without padded headboard, or with wall paneling, where individually upholstered panels act both as a headboard and boiserie.







Qui e nelle pagine precedenti: letto Dream con pannellatura a muro, rivestimento sfoderabile in tessuto Skyros 02 sabbia. Base letto rivestimento sfoderabile in pelle Soft 02 mastice. Biancheria da letto coordinata in cotone Provence 01 bianco con profilo polvere e 08 polvere con profilo bianco. Tavolino Ilda con struttura in fusione d'ottone bronzata e piano in lapislazzulo blu. Poltrone Santa Monica in pelle sfoderabile Nabuk 02 tortora. Tavolino Soori in metallo finitura bronzo anticato. Scrivania Mathieu in brown nickel lucido, piano con cornice rovere spessart e inserto in cuoio 29 tortora. Sedia Guest in pelle non sfoderabile Soft 10 prugna, cuscino seduta sfoderabile nella stessa finitura. Armadio Senzafine Bangkok, ante in cuoio 28 avorio.

This and previous pages: Dream bed with wall panelling, removable covering in fabric Skyros 02 sabbia. Bed frame with removable covering in leather Soft 02 mastice. Coordinated bed linen in cotton Provence 01 bianco with profile in polvere and 08 polvere with profile in bianco. Ilda coffee table with structure in bronzed brass casting and top in blue lapis lazuli. Santa Monica armchairs in removable leather Nabuk 02 tortora. Soori coffee table in antique bronze finished metal. Mathieu desk in glossy brown nickel, top with frame in spessart oak and inlay in hide 29 tortora. Guest chair in non-removable leather Soft 10 prugna, seat cushion with removable cover in the same material. Senzafine Bangkok wardrobe, doors in hide 28 avorio.







Qui e nella pagina precedente: letto Dream con testata e base imbottite, rivestimento sfoderabile in tessuto Naxos 17 corda. Biancheria da letto coordinata in cotone Provence 03 ghiaccio con profilo nero e 06 roccia con profilo roccia. Nella pagina successiva: letto Dream con pannellatura a muro, rivestimento sfoderabile in tessuto Micene 08 argilla. Base letto rivestimento sfoderabile in pelle Silk 11 cognac. Biancheria da letto coordinata in cotone Provence 01 bianco con profilo bianco e 08 polvere con profilo bianco.

This and previous page: Dream bed with padded headboard and bed frame, removable covering in fabric Naxos 17 corda. Coordinated bed linen in cotton Provence 08 polvere with profile in nero and 06 roccia with profile in roccia. Next page: Dream bed with wall panelling, removable covering in fabric Micene 08 argilla. Bed frame with removable covering in leather Silk 11 cognac. Coordinated bed linen in cotton Provence 01 bianco with profile in bianco and 08 polvere with profile in bianco.

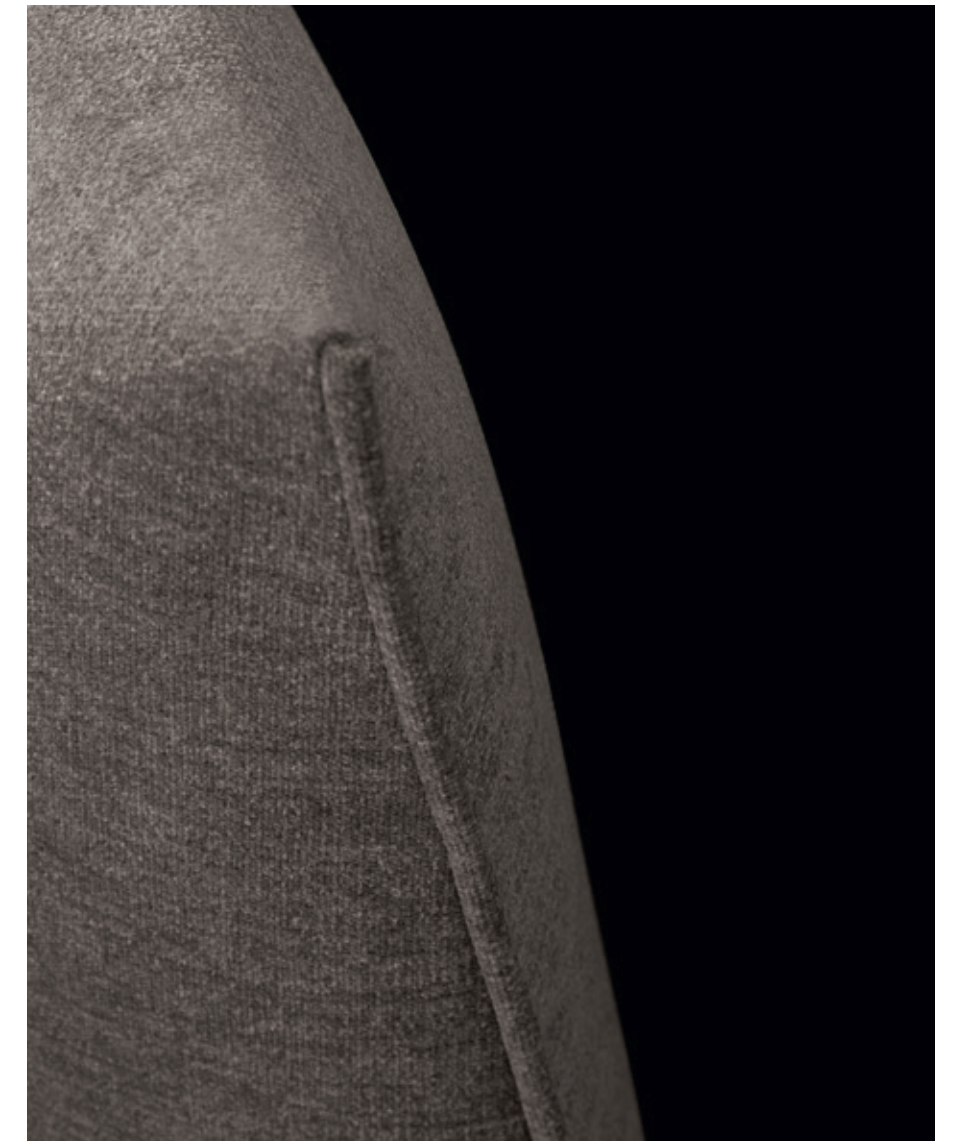



Qui e nelle pagine successive: letto Dream con pannellatura a muro, rivestimento sfoderabile in pelle Special 40 ardesia e velluto Persia 1404 carbone. Base letto rivestimento sfoderabile in pelle Special 40 ardesia. Biancheria da letto coordinata in cotone Provence 01 bianco e 04 tortora con profilo nero. Comodini Dream in laccato lucido moka. Poltrone Gaston con rivestimento non sfoderabile in pelle Soft 13 carbone, struttura verniciata lucido carbone e bracciolo rivestito con la stessa pelle della seduta. Tappeto Soft.

This and next pages: Dream bed with wall panelling, removable covering in leather Special 40 ardesia and velvet Persia 1404 carbone. Bed frame with removable covering in leather Special 40 ardesia. Coordinated bed linen in cotton Provence 01 bianco and 04 tortora with profile in nero. Dream night tables in glossy lacquer moka. Gaston armchairs with non-removable cover in leather Soft 13 carbone, carbone glossy lacquered structure and armrest covered in the same leather of the seat. Carpet Soft.

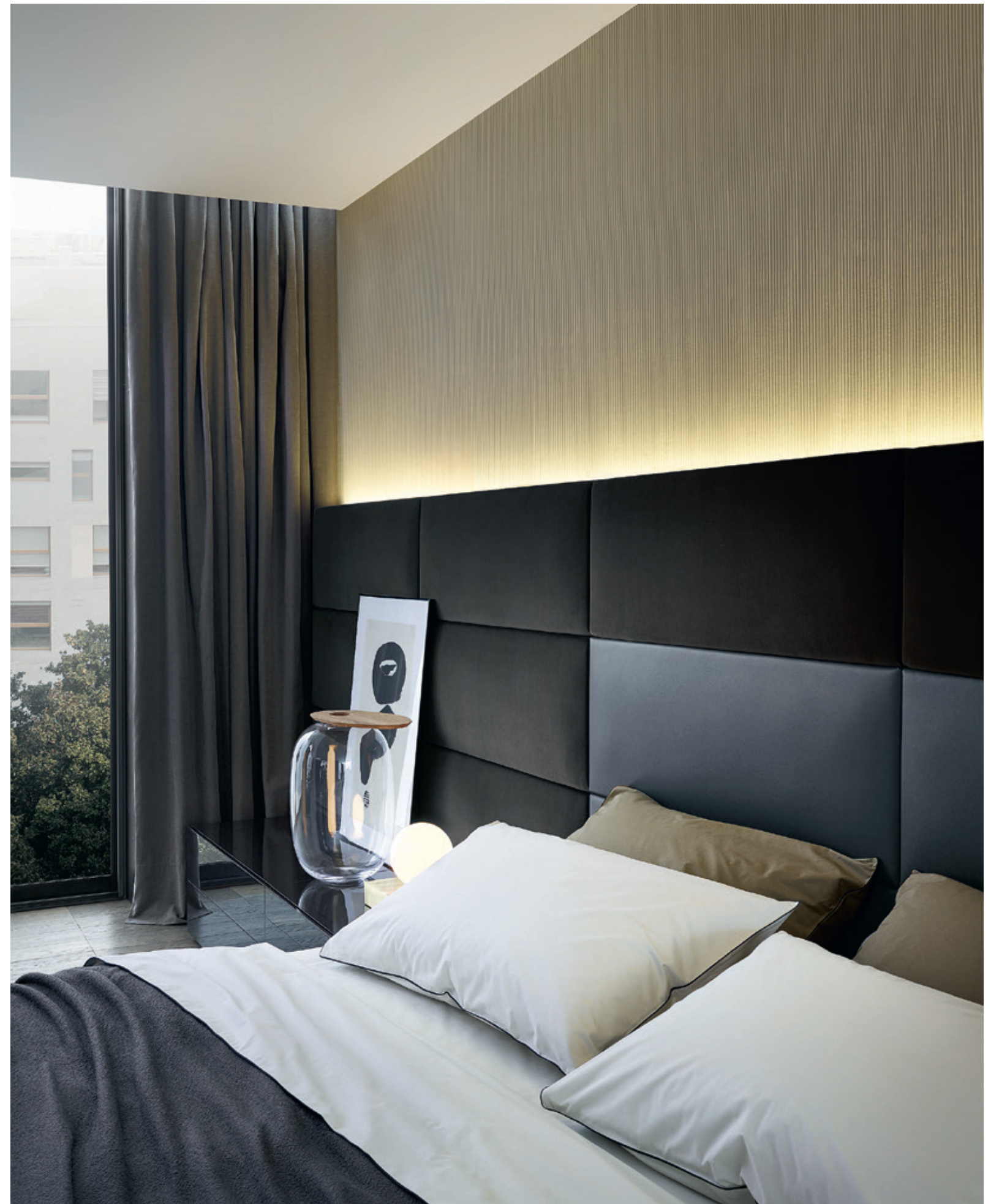





DREAM

Design Marcel Wanders studio, 2006

Letto disponibile in tre varianti, con pannellatura a muro, con testata o base letto imbottita su quattro lati.
 Base letto imbottita, pannello di particelle di legno, imbottitura in poliuretano flessibile con prerivestimento in fibra di poliestere e rivestimento sfoderabile in tessuto o pelle. Pannellatura comprensiva di ferramenta per fissaggio a muro, con possibilità di predisposizione gruppo interruttore e prese elettriche. Pannelli di particelle di legno, imbottitura in poliuretano flessibile stampato e rivestimento sfoderabile in tessuto o pelle.
 Testata imbottita in poliuretano flessibile stampato, prerivestimento in fibra di poliestere e rivestimento sfoderabile in tessuto o pelle. Coppia rulli opzionale con rivestimento sfoderabile in tessuto o pelle.

Pannelli a muro:
 l 690-955-1037 - h 370

Predisposto per materassi:
 l 1600-1800 x p 2000-2100
Queen size base letto l 1795 x p 2300
 materasso l 1525 x p 2030
King size letto l 2200 x p 2300
 materasso l 1930 x p 2030

Tipologia di rete:
 - rete fissa
 - reti anatomiche
 - contenitore con rete ribaltabile (escluso versione base letto imbottita quattro lati)

Bed available in three versions, with wall panelling, with headboard or with padded bed frame on all four sides.
 Padded bed frame, wood particle board, padding in flexible polyurethane with pre-covering in polyester fibre and removable fabric or leather covering. Pannellung includes the hardware for wall fixing, with the possibility of switch unit and electrical sockets arrangement. Panels of wood particles, padding in moulded flexible polyurethane and removable fabric or leather covering. Padded headboard in moulded flexible polyurethane, pre-covering in polyester fibre and removable fabric or leather covering.
 Optional pair of roll cushions with removable fabric or leather covering.

Wall panels:
 w 27 1/4"-37 1/2"-40 3/4" - h 14 1/2"

For mattresses:
 w 63"-70 3/4" x d 78 3/4"-82 3/4"
Queen size bed frame w 70 3/4" x d 90 1/2"
 for mattress w 60" x d 80"
King size bed frame w 86 1/2" x d 90 1/2"
 for mattress w 76" x d 80"

Bedstead type:
 - fixed bedstead
 - anatomic bedsteads
 - container box with tip-up bedstead (except padded bed frame on four sides)

Base letto imbottita 4 lati 4-sided padded bed frame

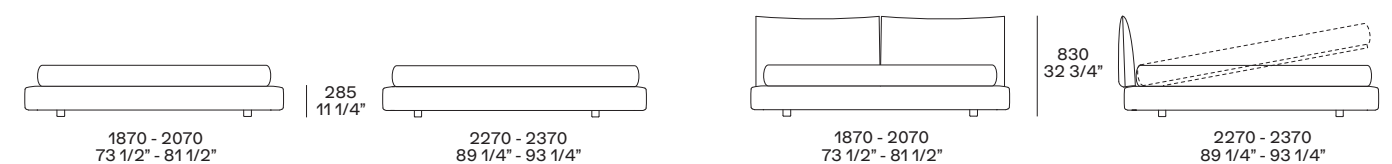

Base letto con pannellatura Bed frame with panelling

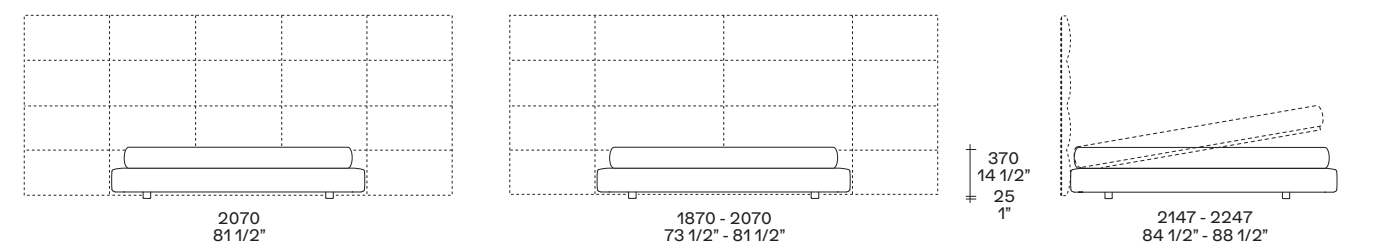

tre pannelli l 690 per materasso l 1800
 three panels w 27 1/4" for mattress w 70 3/4"

due pannelli l 955 per materasso l 1600
 due pannelli l 1037 per materasso l 1800
 two panels w 37 1/2" for mattress w 63"
 two panels w 40 3/4" for mattress w 70 3/4"

Queen size e King size solo per la versione con pannellatura.
 Queen size and King size only available for the version with wall panelling.

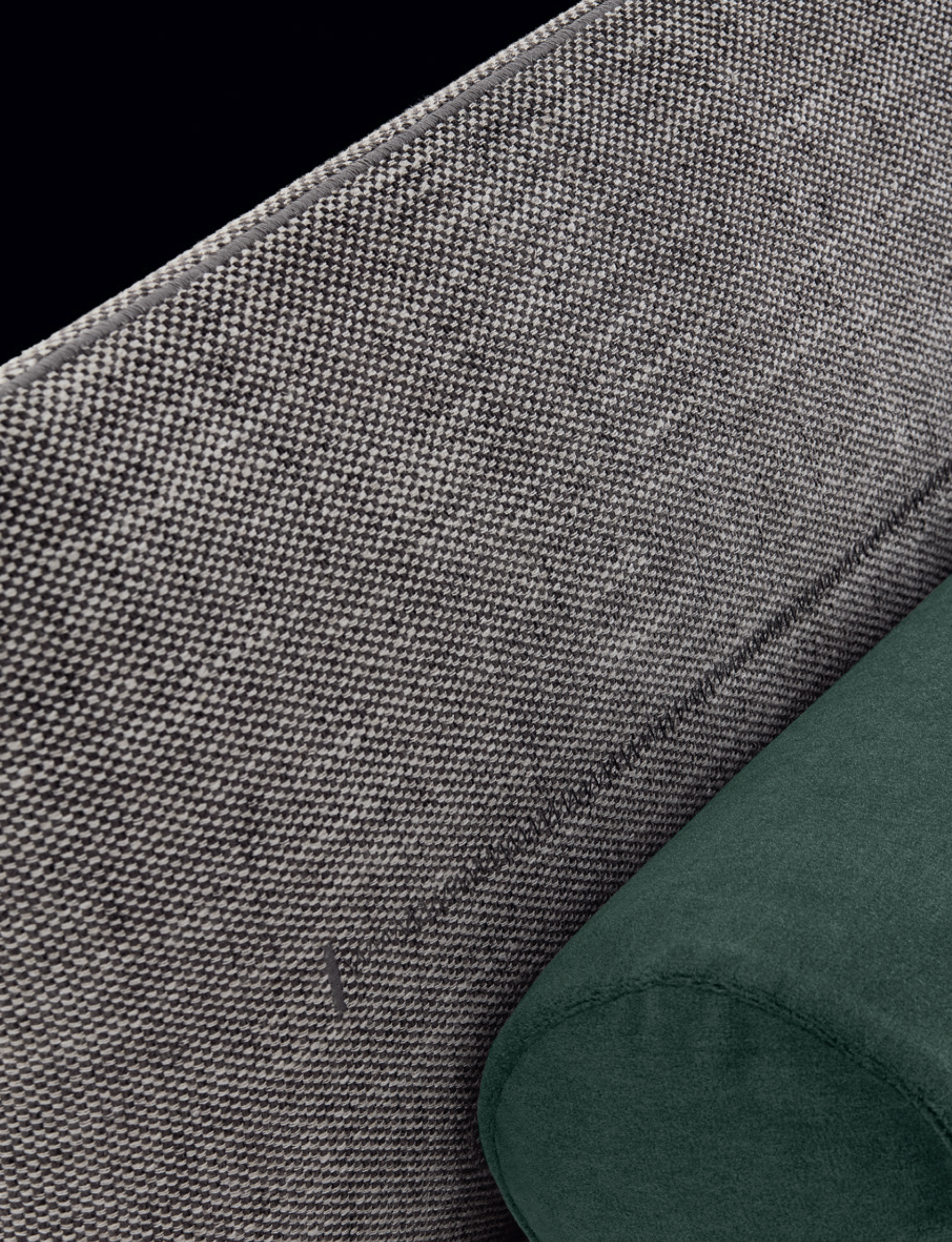

JACQUELINE

Jacqueline di Jean-Marie Massaud è un letto tessile dall'aspetto confortevole e dallo stile informale. Nella versione in tessuto, testata e giroletto sono caratterizzati dagli inserti ricamati e dagli alamari in colori a contrasto. Doppio o singolo, Jacqueline è disponibile anche rivestito in pelle.

Jacqueline by Jean-Marie Massaud is a comfortable textile bed with an informal style. In the fabric version, headboard and bed frame are characterized by embroidered inserts and fasteners in contrasting colours. Double or single, Jacqueline is also available in leather.





Qui e nelle pagine precedenti: letto Jacqueline, testata e base imbottite con rivestimento sfoderabile in tessuto Lima 67 pernice e cuciture a cordoncino in colore nero. Rulli in pelle sfoderabile Silk 10 terracotta. Biancheria da letto coordinata in cotone Provence 01 bianco e 08 polvere con profili nero. Coperta Linus grafite. Tavolini Nara in legno massello tinto olmo nero. Poltrona Kay Lounge in pelle non sfoderabile Hairy cappuccino e struttura in brown nickel opaco. Tavolino Dama in legno massello noce. Poltrona Gentleman Reserved e pouf Gentleman in pelle sfoderabile Silk 10 terracotta, basamento in champagne opaco. Tappeto Plain natural.

This and previous pages: Jacqueline bed, padded headboard and bed frame with removable cover in fabric Lima 67 pernice and drawstring stitchings in black colour. Roll cushions in removable leather Silk 10 terracotta. Coordinated bed linen in cotton Provence 01 bianco and 08 polvere with profiles in nero. Blanket Linus grafite. Nara coffee tables in solid wood stained black elm. Kay Lounge armchair in non-removable leather Hairy cappuccino and mat brown nickel structure. Dama coffee table in solid wood walnut. Gentleman Reserved armchair and Gentleman pouf in removable leather Silk 10 terracotta and base in mat champagne. Carpet Plain natural.







Qui e nella pagina precedente: letto Jacqueline, testata e base imbottite con rivestimento sfoderabile in pelle Nabuk 09 ruggine. Rulli in pelle sfoderabile Nabuk 09 ruggine. Biancheria da letto coordinata in cotone Provence 01 bianco con profilo polvere e 08 polvere con profilo bianco.

This and previous page: Jacqueline bed, padded headboard and bed frame with removable covering in leather Nabuk 09 ruggine. Roll cushions in removable leather Nabuk 09 ruggine. Coordinated bed linen in cotton Provence 01 bianco with profile in polvere and 08 polvere with profile in bianco.







Qui e nella pagina precedente: letto Jacqueline, testata e base imbottite con rivestimento sfoderabile in tessuto Kitami 04 sabbia e cuciture a cordoncino in colore nero. Rulli in tessuto sfoderabile Kitami 04 sabbia. Biancheria da letto coordinata in cotone Provence 01 bianco e 07 grafite con profili nero. Coperta Linus grafite. Nella pagina successiva: letto singolo Jacqueline, testata e base imbottite con rivestimento sfoderabile in tessuto Rabat 412 cemento e cuciture a cordoncino in colore acciaio. Rullo in velluto sfoderabile Tebe 06 giada. Biancheria da letto coordinata in cotone Provence 01 bianco con profilo nero e 08 polvere con profilo polvere.

This and previous page: Jacqueline bed, padded headboard and bed frame with removable covering in fabric Kitami 04 sabbia and piping in colour nero. Roll cushions in removable fabric Kitami 04 sabbia. Coordinated bed linen in cotton Provence 01 bianco and 07 grafite with profiles in nero. Blanket Linus grafite. Next page: Jacqueline single bed, padded headboard and bed frame with removable covering in fabric Rabat 412 cemento and piping in colour acciaio. Roll cushions in removable velvet Tebe 06 giada. Coordinated bed linen in cotton Provence 01 bianco with profile in nero and 08 polvere with profile in polvere.





Qui e nelle pagine successive: letto Jacqueline, testata e base imbottite con rivestimento sfoderabile in tessuto Lima 43 écru e cuciture a cordoncino in colore acciaio. Biancheria da letto coordinata in cotone Provence 01 bianco con profilo nero e 06 roccia. Tavolino Flute laccato opaco carbone e piano in marmo emperador dark lucido. Pouf Play rivestimento sfoderabile in velluto Persia 1403 ocra. Comodino Pandora in rovere spessart. Poltrona Mad Chair rivestimento in velluto sfoderabile Persia 1401 oliva, gambe in rovere spessart. Tappeto Dama. Sotto: un dettaglio della cucitura della base con travetta a contrasto. La testata è caratterizzata dalla cucitura a cordoncino perimetrale, dagli alamari e dalle cuciture decorative a contrasto.

This and next pages: Jacqueline bed, padded headboard and bed frame with removable covering in fabric Lima 43 écru and piping in colour acciaio. Coordinated bed linen in cotton Provence 01 bianco with profile in nero and Provence 06 roccia. Flute coffee table in mat lacquer carbone with glossy emperador dark marble top. Play pouf with removable covering in velvet Persia 1403 ocra. Pandora night table in spessart oak. Mad Chair armchair with removable covering in velvet Persia 1401 oliva, legs in spessart oak. Carpet Dama. Below: a detail of the bed frame bartack stitching in contrasting colour. The perimeter drawstring stitching, the fasteners and the contrasting decorative stitching characterize the headboard.







JACQUELINE

Design Jean-Marie Massaud, 2011

Letto con testata imbottita in poliuretano flessibile stampato e prerivestimento in piuma. Base letto imbottita, pannello di particelle di legno, imbottitura in poliuretano flessibile con prerivestimento in fibra di poliestere.

Rivestimento sfoderabile in tessuto o pelle. Cucitura normale doppia o a cordoncino con filato nei diversi colori da campionario (escluso pelle o velluto).

Nella versione in tessuto, testata con cucitura a cordoncino perimetrale, cuciture decorative e alamari, base con travetta. Coppia rulli opzionale con rivestimento sfoderabile in tessuto o pelle.

Predisposto per materassi:

l 1000-1600-1800 x p 2000-2100

Queen size letto l 1804 x p 2190
materasso l 1525 x p 2030

King size letto l 2210 x p 2190
materasso l 1930 x p 2030

Tipologia di rete:

- rete fissa
- reti anatomiche
- contenitore con rete ribaltabile

Bed with padded headboard in moulded flexible polyurethane and pre-covering in down. Padded bed frame, wood particle board, padding in flexible polyurethane with pre-covering in polyester fibre.

Removable fabric or leather covering. Normal double stitching or drawstring stitching in the sample colours (except leather or velvet).

In the fabric version, headboard with perimeter drawstring stitching, decorative stitching and fasteners, bed frame with bartack stitching.

Optional pair of roll cushions with removable fabric or leather covering.

For mattresses:

w 39 1/4"-63"-70 3/4" x d 78 3/4"-82 3/4"

Queen size bed w 71" x d 86 1/4"
for mattress w 60" x d 80"

King size bed w 87" x d 86 1/4"
for mattress w 76" x d 80"

Bedstead type:

- fixed bedstead
- anatomic bedsteads
- container box with tip-up bedstead

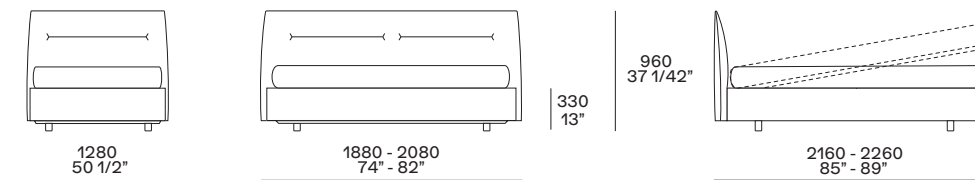

cuciture testata versione in pelle
headboard stitching leather version

CHLOE

Progettato da Carlo Colombo per essere avvolgente come un abbraccio, Chloe è un letto contraddistinto dalla particolare testata che crea due piccole ali – una forma ripresa anche nella cassettoniera e nei comodini della stessa serie. Completamente imbottito, può essere profilato in gros-grain in tinta o a contrasto.

Designed by Carlo Colombo to be as enveloping as a hug, Chloe is a bed characterized by the particular headboard that creates two small wings – a shape also referenced by the chest of drawers and night tables of the same series. Completely upholstered, it can be profiled in grosgrain with the same colour or in contrast.







Qui, nelle pagine precedenti e in chiusura: letto Chloe, testata e base imbottite con rivestimento sfoderabile in tessuto Naxos 07 cemento, bordure gros-grain color acciaio. Biancheria da letto coordinata in cotone Provence 01 bianco con profilo nero. Coperta Linus granata. Quid boiserie in olmo nero. Comodini Chloe struttura esterna in cuoio 29 tortora e interna in brown nickel lucido, cassetti e top in olmo nero. Tavolino Baba in metallo verniciato oro lucido e piano in vetro oro. Poltrona Mad Chair in tessuto sfoderabile Nancy 125 sabbia, basamento girevole in brown nickel lucido. Tavolino Dama in laccato lucido visone. Tappeto Soft grigio.

This, previous pages and closing page: Chloe bed, padded headboard and bed frame with removable covering in fabric Naxos 07 cemento, piping in colour acciaio. Coordinated bed linen in cotton Provence 01 bianco with profile in nero. Blanket Linus granata. Quid wall panelling in black elm. Chloe night tables with outer structure in hide 29 tortora and inner structure in glossy brown nickel, drawers and top in black elm. Baba coffee table in glossy gold painted metal and glossy glass top. Mad Chair armchair in removable fabric Nancy 125 sabbia, swivel base in glossy brown nickel. Dama coffee table in glossy lacquer visone. Carpet Soft grigio.





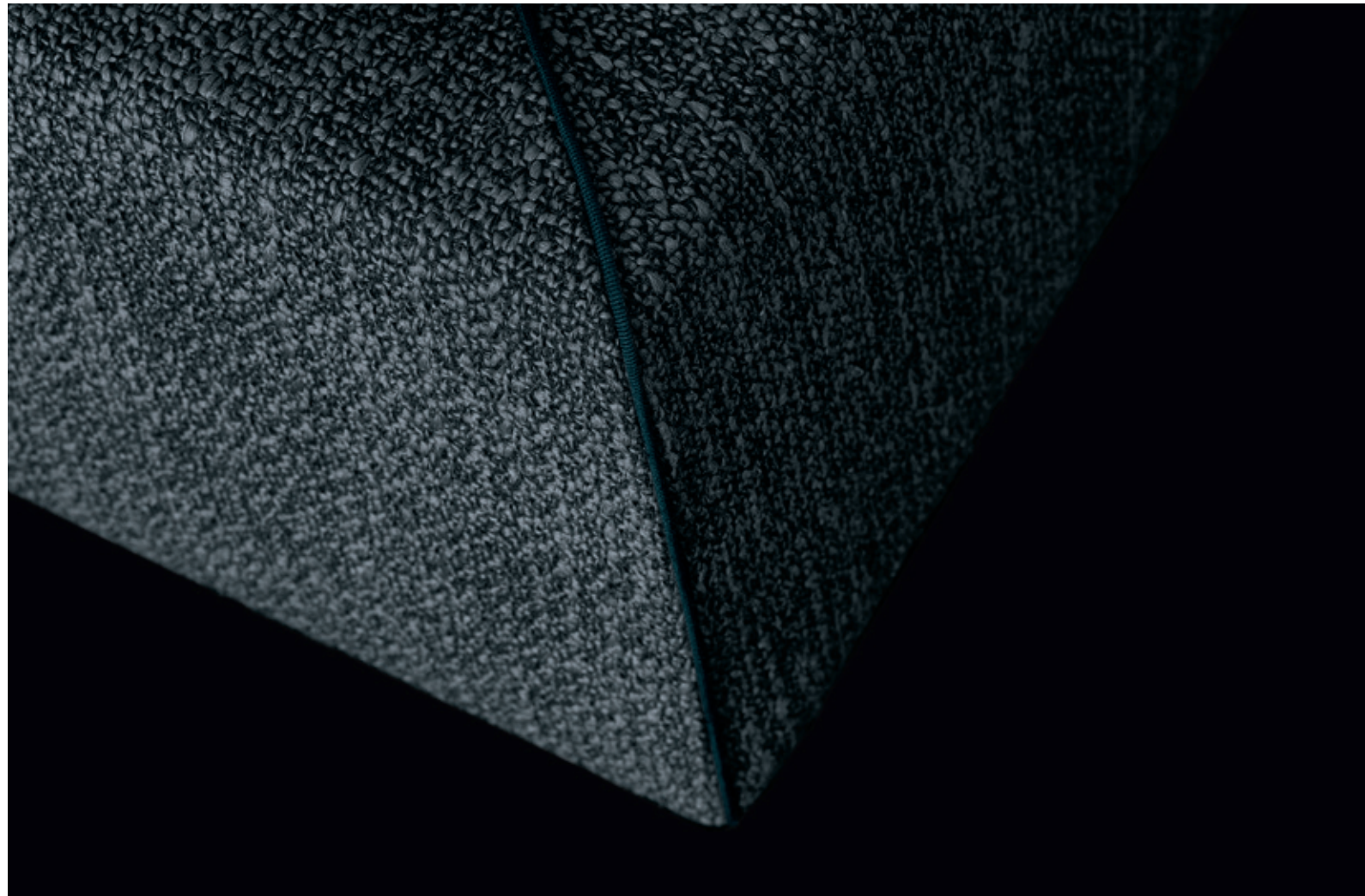

Qui e nella pagina precedente: letto Chloe, testata e base imbottite con rivestimento sfoderabile in tessuto Antea 10 grafite, bordure gros-grain color tempesta. Rulli in velluto sfoderabile Tebe 08 notte. Biancheria da letto coordinata in cotone Provence 03 ghiaccio e 07 grafite con profili bianco. Coperte Linus latte e grafite.

This and previous page: Chloe bed, padded headboard and bed frame with removable covering in fabric Antea 10 grafite and piping in colour tempesta. Roll cushions in removable velvet Tebe 08 notte. Coordinated bed linen in cotton Provence 03 ghiaccio and 07 grafite with profiles in bianco. Blankets Linus latte and grafite.

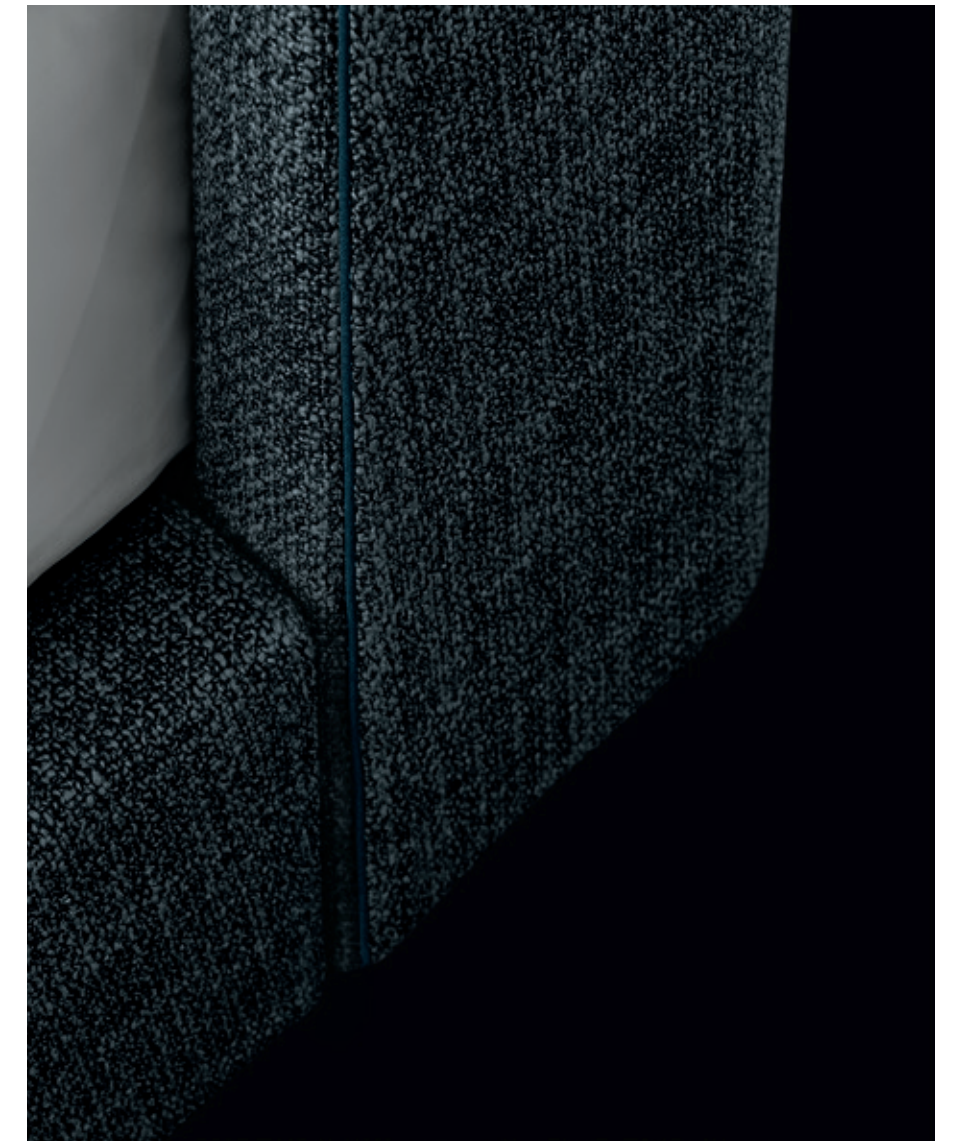



CHLOE

Design Carlo Colombo, 2017

Letto con testata imbottita in poliuretano flessibile stampato con prerivestimento in fibra di poliestere. Base letto imbottita, pannello di particelle di legno, imbottitura in poliuretano flessibile con prerivestimento in fibra di poliestere.

Rivestimento sfoderabile in tessuto o pelle. Cucitura normale o bordure gros-grain nei diversi colori da campionario (escluso rivestimento in pelle e velluto). Coppia rulli opzionale con rivestimento sfoderabile in tessuto o pelle.

Predisposto per materassi:
l 1600-1800 x p 2000-2100

Tipologia di rete:

- rete fissa
- reti anatomiche
- contenitore con rete ribaltabile

Bed with padded headboard in moulded flexible polyurethane and pre-covering in polyester fibre. Padded bed frame, wood particle board, padding in flexible polyurethane with pre-covering in polyester fibre.

Removable fabric or leather covering. Normal stitching or piping in gros-grain in the sample colours (except leather and velvet covering). Optional pair of roll cushions with removable fabric or leather covering.

For mattresses:
w 63"-70 3/4" x d 78 3/4"-82 3/4"

Bedstead type:

- fixed bedstead
- anatomic bedsteads
- container box with tip-up bedstead

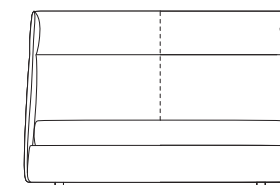
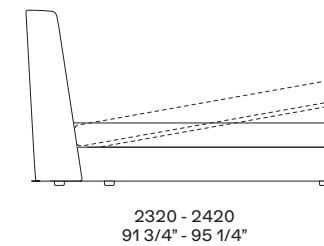
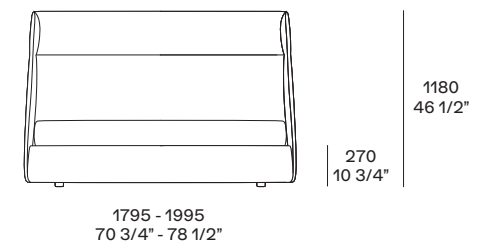

cuciture testata versione in pelle
headboard stitching leather version

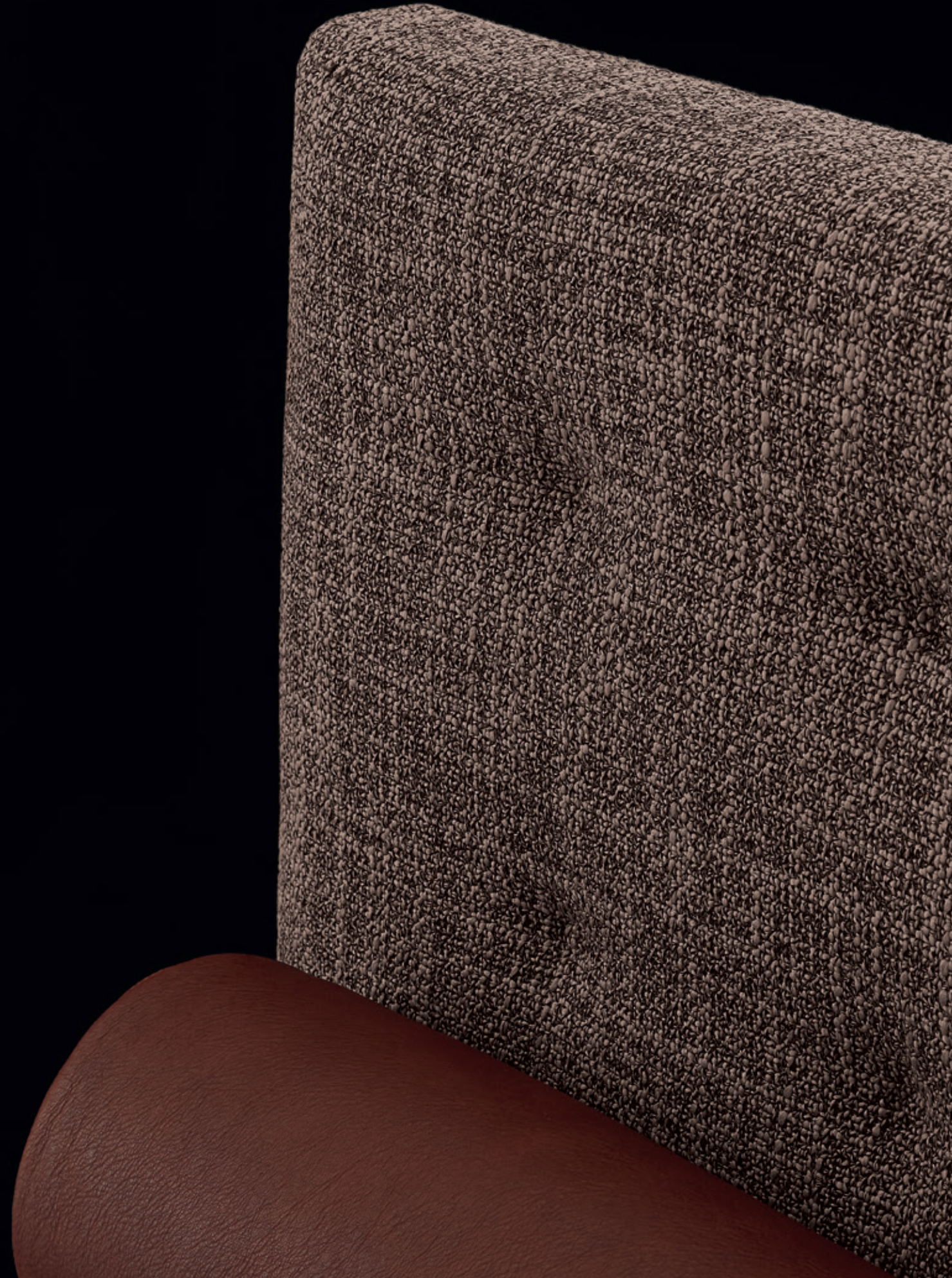

ARCA

Arca è un sistema versatile, che si personalizza affiancando alla base tessile due tipologie di testata: più romantica quella trapuntata, più essenziale quella liscia. Una proposta firmata Poliform che interpreta stili diversi, disponibile anche in versione singola.

Arca is a versatile system that you can customize by adding two types of headboard to the textile base: more romantic the quilted one, more minimalistic the smooth one. An offer designed by Poliform that interprets different styles, also available in single version.

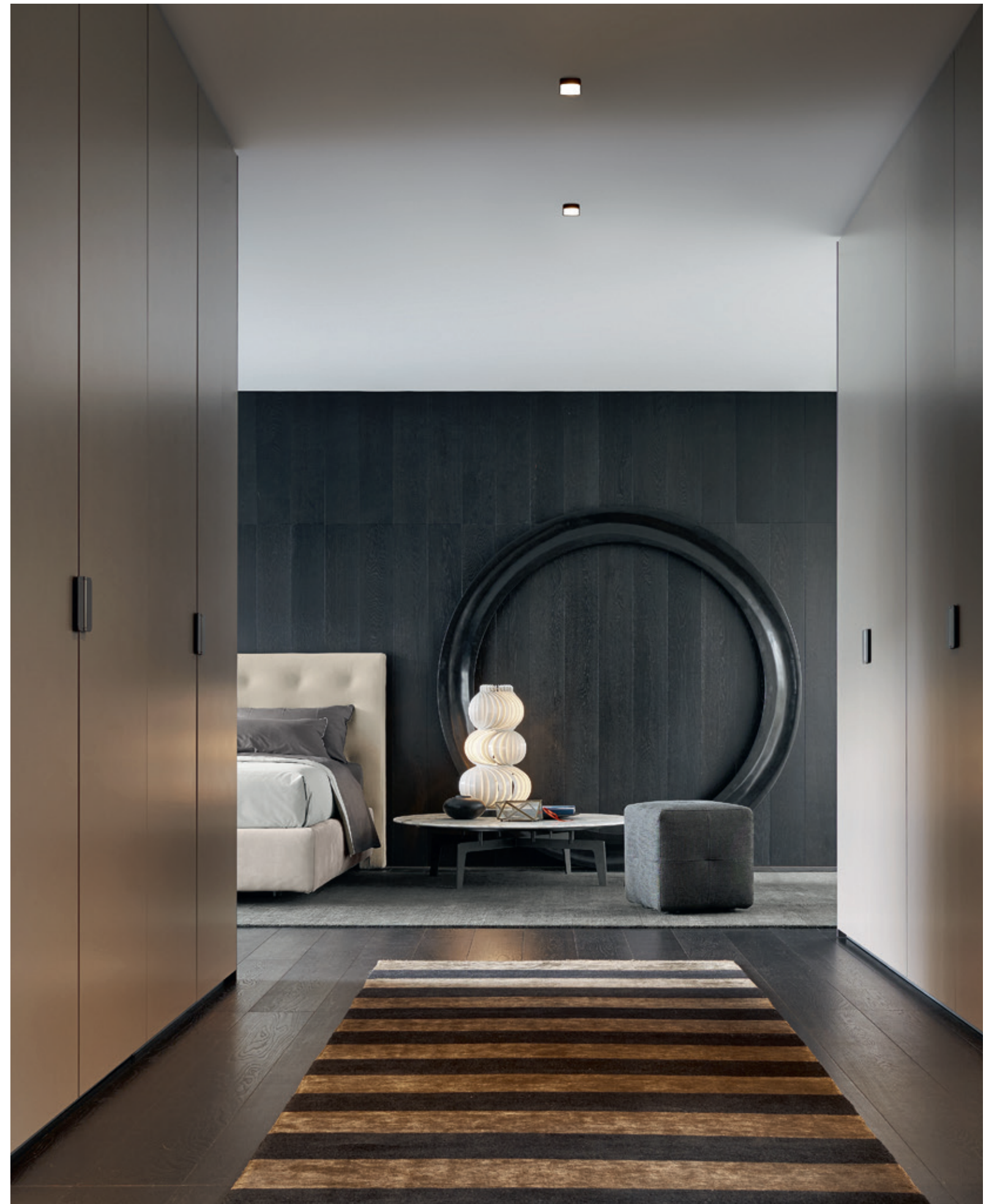



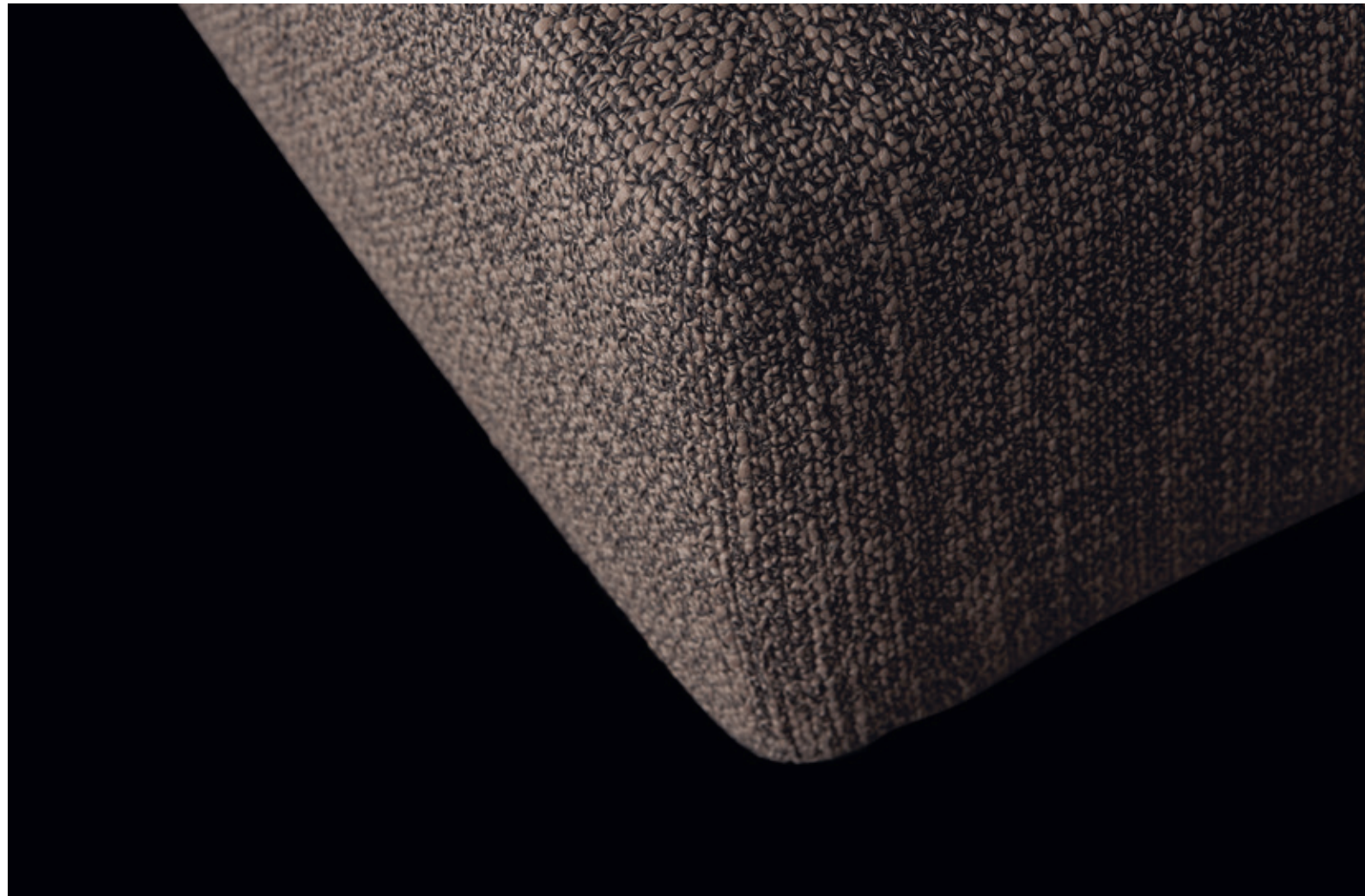

Nelle pagine precedenti e in chiusura: letto Arca con testata imbottita trapuntata, rivestimento sfoderabile in pelle Nabuk 01 latte. Biancheria da letto coordinata in cotone Provence 06 roccia con profilo bianco e nero e 03 ghiaccio con profilo bianco. Tavolino Tribeca in brown nickel opaco con piano in marmo calacatta oro lucido. Comodino You in rovere spessart. Pouf Onda in tessuto non sfoderabile Arcadia 09 grafite. Armadio Senzafine New Entry in laccato opaco arena. Tappeto Stripes. Qui e nella pagina successiva: letto Arca con testata imbottita trapuntata, rivestimento sfoderabile in tessuto Antea 05 terra di siena. Rulli in pelle sfoderabile Silk 10 terracotta. Biancheria da letto coordinata in cotone Provence 01 bianco con profilo polvere e 08 polvere con profilo bianco.

Previous pages and closing page: Arca bed with quilted padded headboard, removable covering in leather Nabuk 01 latte. Coordinated bed linen in cotton Provence 06 roccia with profile in bianco and nero and 08 polvere with profile in bianco. Tribeca coffee table in mat brown nickel with glossy calacatta oro marble top. You night table in spessart oak. Onda pouf in non-removable fabric Arcadia 09 grafite. Senzafine New Entry wardrobe in mat lacquer arena. Carpet Stripes. This and next page: Arca bed with quilted padded headboard, removable covering in fabric Antea 05 terra di siena. Roll cushions in removable leather Silk 10 terracotta. Coordinated bed linen in cotton Provence 01 bianco with profile in polvere and 08 polvere with profile in bianco.





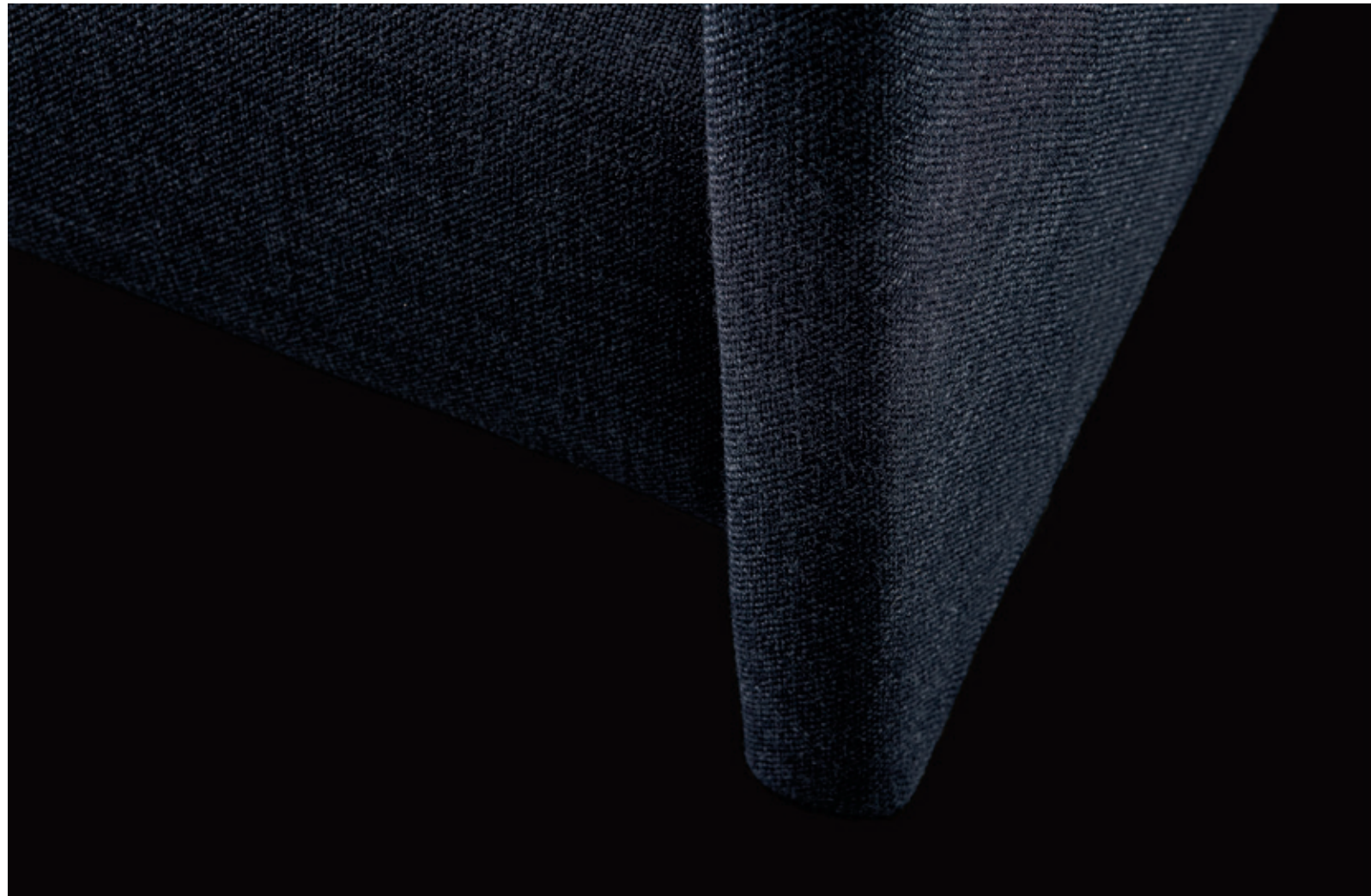

Qui e nella pagina successiva: letto singolo Arca con rivestimento sfoderabile in tessuto Caleo 11 navy. Rullo in velluto sfoderabile Persia 54 prussia. Biancheria da letto coordinata in cotone Provence 01 bianco con profilo roccia e 06 roccia con profilo bianco.

This and next page: Arca single bed with removable covering in fabric Caleo 11 navy. Roll cushion in removable velvet Persia 54 prussia. Coordinated bed linen in cotton Provence 01 bianco with profile in roccia and 06 roccia with profile in bianco.







ARCA

Design R&D Poliform, 2003

Letto disponibile in tre varianti, con testata imbottita, con testata imbottita trapuntata o base letto imbottita quattro lati.

Base letto e testate, pannello di particelle di legno, imbottitura in poliuretano flessibile con prerivestimento in fibra di poliestere. Rivestimento sfoderabile in tessuto o pelle. Retro testate disponibile in due versioni, in tela nera e in tessuto o pelle nella stessa finitura della parte frontale. Coppia rulli opzionale con rivestimento sfoderabile in tessuto o pelle.

Predisposto per materassi:
l 1000-1400-1600-1800-2000 x p 2000-2100

Queen size con testata imbottita trapuntata, letto l 1778 x p 2190 materasso l 1525 x p 2030

King size con testata imbottita trapuntata, letto l 2184 x p 2190 materasso l 1930 x p 2030

Tipologia di rete:

- rete fissa
- reti anatomiche
- contenitore con rete ribaltabile (escluso materasso l 2000)

Bed available in three versions, with padded headboard, with quilted padded headboard or with padded bed frame on all four sides. Bed frame and headboards, wood particle board, padding in flexible polyurethane with pre-covering in polyester fibre. Removable fabric or leather covering. Headboard backside available in two versions, in black canvas and in fabric or leather in the same finish as the front part. Optional pair of roll cushions with removable fabric or leather covering.

For mattresses:

w 39 1/4"-55"-63"-70 3/4"-78 3/4" x d 78 3/4"-82 3/4"

Queen size with quilted padded headboard, bed w 70" x d 86 1/4" for mattress w 60" x d 80"

King size with quilted padded headboard, bed w 86" x d 86 1/4" for mattress w 76" x d 80"

Bedstead type:

- fixed bedstead
- anatomic bedsteads
- container box with tip-up bedstead (except mattress w 78 3/4")

Base letto imbottita 4 lati 4-sided padded bed frame

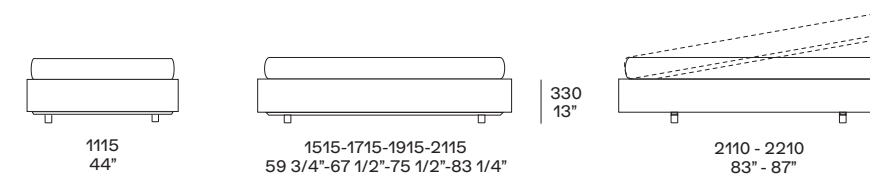

Base letto con testata imbottita Bed frame with padded headboard

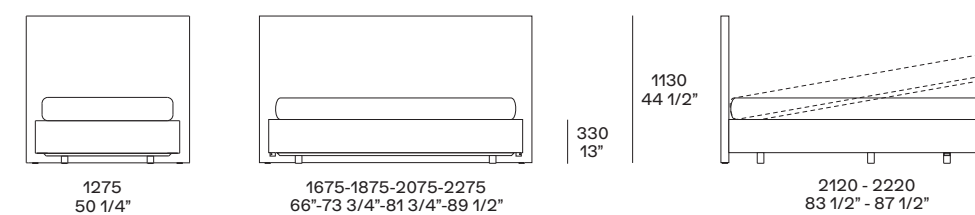

Base letto con testata imbottita trapuntata Bed frame with quilted padded headboard

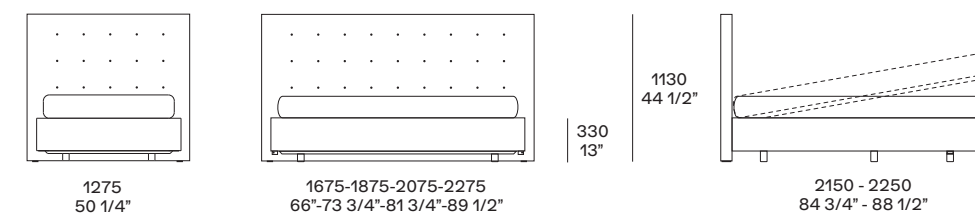

ONDA

Moderno e rigoroso, il letto Onda di Paolo Piva rappresenta un unicum della collezione. Gambe leggere in metallo sorreggono una struttura molto caratterizzata, un tutt'uno che fa da base e testata in pelle lavorata a capitonné per un vero primo attore dello spazio notte.

Modern and rigorous, the Onda bed by Paolo Piva is unique in the collection. Light metal legs support a very distinctive structure, a whole that acts as base and headboard in capitonné leather for a true leading actor of the night space.





Qui e nelle pagine precedenti: letto Onda, rivestimento non sfoderabile con lavorazione capitonné in pelle Silk 10 terracotta, piedini brown nickel opaco. Biancheria da letto coordinata in cotone Provence 04 tortora e 06 roccia. Sistema giorno Code, boiserie in tessuto lino chiaro con profili in champagne opaco; da un lato, contenitore sospeso retroilluminato in laccato metallico ottone con top in marmo zecevo levigato e vano a giorno in laccato opaco ottone; dall'altro, mensola retroilluminata in laccato metallico ottone; di fronte al letto, contenitori sospesi in noce gold con top retroilluminato in marmo zecevo levigato, mensolone retroilluminato in laccato opaco visone. Poltrone Gentleman Single in tessuto sfoderabile Kitami 04 sabbia e gros-grain sahara, basamento in brown nickel lucido. Tavolino Dama in legno massello noce. Tavolino Soori in metallo finitura bronzo anticato.

This and previous pages: Onda bed, non-removable cover with capitonné manufacturing in leather Silk 10 terracotta, mat brown nickel feet. Coordinated bed linen in cotton Provence 04 tortora and 06 roccia. Code day system, wall panelling in fabric lino chiaro with mat champagne profiles; on one side, backlit suspended storage unit in metal lacquer ottone with top in mat marble zecevo and open compartment in mat lacquer ottone; on the other side, backlit shelf in metal lacquer ottone. In front of the bed, suspended storage units in gold walnut with backlit top in mat marble zecevo, backlit thick shelf in mat lacquer visone. Gentleman Single armchairs in removable fabric Kitami 04 sabbia and grosgrain sahara, base in glossy brown nickel. Dama coffee table in solid wood walnut. Soori coffee table in metal with antique bronze finish.







Qui e nella pagina precedente: letto Onda, rivestimento non sfoderabile con lavorazione capitonné in pelle Silk 10 terracotta, piedini in brown nickel opaco. Biancheria da letto coordinata in cotone Provence 01 bianco e 08 polvere con profili bianco. Nelle pagine successive: letto Onda, rivestimento non sfoderabile con lavorazione capitonné in pelle Invecchiata 880 nero, piedini in brown nickel opaco. Biancheria da letto coordinata in cotone Provence 08 polvere con profilo nero. Comodino Onda in rovere spessart.

This and previous page: Onda bed, non-removable cover with capitonné manufacturing in leather Silk 10 terracotta, mat brown nickel feet. Coordinated bed linen in cotton Provence 01 bianco and 08 polvere with profiles in bianco. Next pages: Onda bed, non-removable cover with capitonné manufacturing in leather Invecchiata 880 nero, mat brown nickel feet. Coordinated bed linen in cotton Provence 08 polvere with profile in nero. Onda night table in spessart oak.







ONDA

Design Paolo Piva, 2007

Letto con imbottitura in poliuretano flessibile stampato e prerivestimento in fibra di poliestere. Rivestimento non sfoderabile in pelle con lavorazione capitonné. Piedini brown nickel opaco. Coppia rulli opzionale con rivestimento sfoderabile in tessuto o pelle.

Predisposto per materassi:
l 1600-1800 x p 2000

Tipologia di rete:
- rete fissa
- reti anatomiche

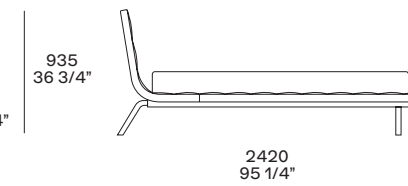
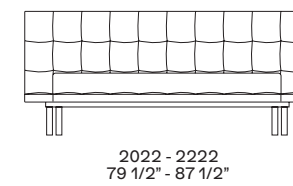

Bed with padding in moulded flexible polyurethane and pre-covering in polyester fibre. Non-removable covering in leather with quilted manufacturing. Mat brown nickel feet. Optional pair of roll cushions with removable fabric or leather covering.

For mattresses:
w 63"-70 3/4" x d 78 3/4"

Bedstead type:
- fixed bedstead
- anatomic bedsteads

STORAGE UNITS

Comodini e cassettiere sono progettati per accompagnare i letti della collezione. Carlo Colombo, Emmanuel Gallina e Marcel Wanders studio coordinano i complementi con i letti delle serie omonime, creando dei veri e propri sistemi notte. D&T riscrivono l'arte dell'ebanisteria in chiave contemporanea. Poliform invece mette a punto due serie di complementi dall'estetica universale, giusta in ogni contesto, perfetta da abbinare a tutti i letti della collezione.

Night tables and chests of drawers are designed to accompany the beds in the collection. Carlo Colombo, Emmanuel Gallina, and Marcel Wanders studio coordinate the complements with the beds of the homonymous series, creating true night systems. D&T rewrite the art of cabinetry with a contemporary approach. Poliform instead develops two sets of complements with a universal style, fitting every context, perfect to combine with all the beds in the collection.

STORAGE UNITS

GENTLEMAN	171
KELLY	187
ONDA	203
ABBINABILI	217
DREAM	231
CHLOE	245
YOU	257

GENTLEMAN

Nella zona notte la collezione Gentleman si completa con comodini e comò. Le linee sono curve e avvolgenti, perfetto mix di comfort e raffinatezza, mentre i piedini che li sollevano da terra conferiscono agli arredi una postura naturalmente elegante, coerente con lo stile degli altri elementi della serie.

In the bedroom, the Gentleman collection is completed by night tables and chest of drawers. Curved and enveloping lines perfectly combine comfort and refinement. The feet raising the furniture off the ground lend it a naturally elegant posture, creating a cohesive style linking all elements of the series together.



Qui e nella pagina precedente: comodino Gentleman in olmo nero con top in laccato opaco bronzo, basamento con piedini brown nickel lucido. Letto Gentleman in tessuto sfoderabile Agadir 05 crema e bordura gros-grain nero, piedini e profilo in brown nickel lucido. Rulli in pelle sfoderabile Nabuk 04 moka. Biancheria da letto coordinata in cotone Provence 08 polvere e 04 tortora. Dietro al letto, mensolone sospeso retroilluminato Code in olmo nero. Poltrona Gentleman Relax in tessuto sfoderabile Siro 02 lino e basamento brown nickel lucido. Pouf Saint-Germain in pelle sfoderabile Nabuk 06 mastice, piedini brown nickel opaco. Boiserie Code in tessuto lino bruciato e profili champagne opaco. Armadio Senzafine Cover con ante battenti in tessuto lino bruciato e profili champagne opaco. Tappeto Cannelé.

This and previous page: Gentleman night table in black elm with top in mat lacquer bronzo, base with feet in glossy brown nickel. Gentleman bed in removable fabric Agadir 05 crema and border in grosgrain nero, feet and profile in glossy brown nickel. Roll cushions in removable leather Nabuk 04 moka. Coordinated bed linen in cotton Provence 08 polvere and 04 tortora. Behind the bed, Code backlit thick shelf in black elm. Gentleman Relax armchair in removable fabric Siro 02 lino and glossy brown nickel base. Saint-Germain pouf in removable leather Nabuk 06 mastice, mat brown nickel feet. Code wall paneling in fabric lino bruciato with mat champagne profiles. Wardrobe Senzafine Cover with leaf doors in fabric lino bruciato and mat champagne profiles. Carpet Cannelé.



In questa pagina: comodino Gentleman in noce gold con top in laccato opaco champagne, basamento con piedini champagne opaco.

This page: Gentleman coffee table in gold walnut with top in mat lacquer champagne, base with feet in mat champagne.

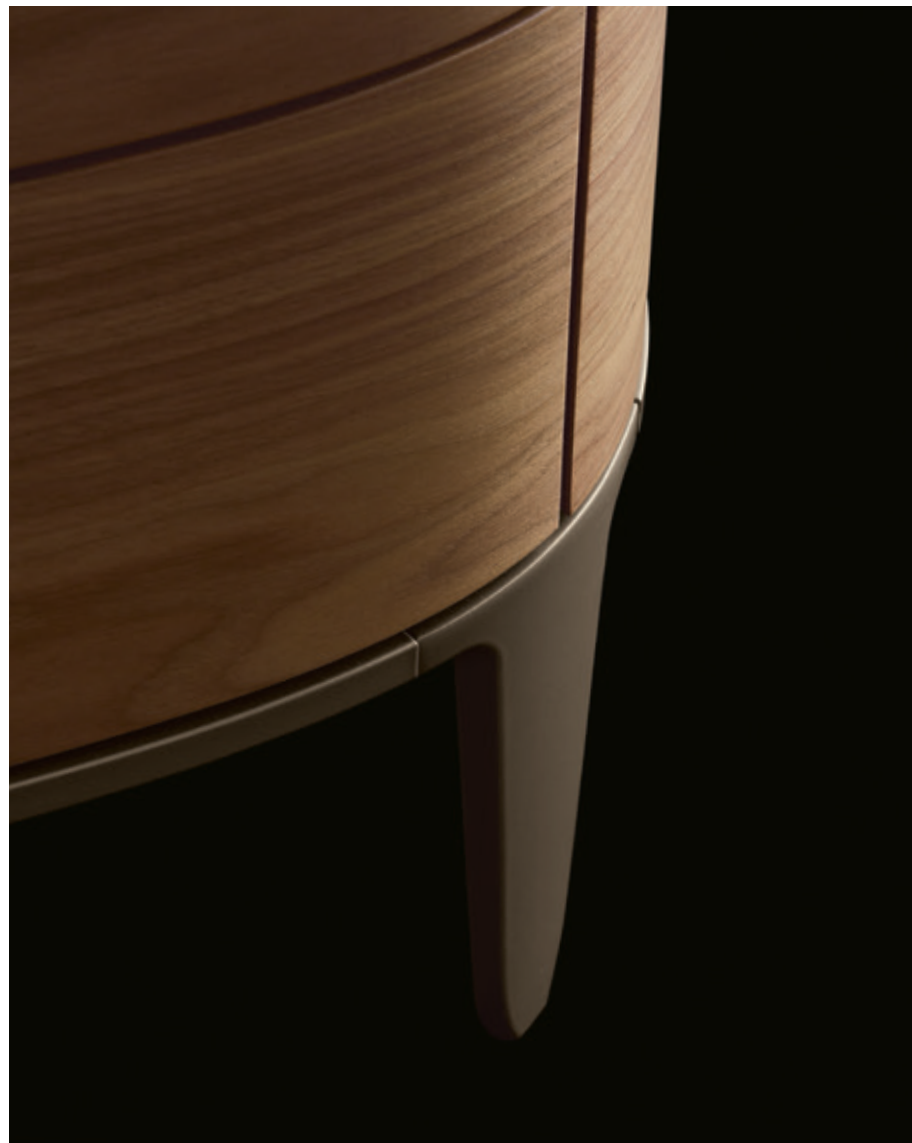





Qui e nella pagina precedente: comodino e cassetiera Gentleman in olmo nero con top in laccato opaco bronzo, basamento con piedini brown nickel lucido. Sotto: dettaglio del comodino Gentleman con cassetto in olmo nero e interno in nobilitato ardesia.

This and previous page: night table and chest of drawers Gentleman in black elm with top in mat lacquer bronzo, base with feet in glossy brown nickel. Below: close up of the Gentleman night table with drawer in black elm and melamine ardesia interior.



Qui e nella pagina successiva: cassetiera Gentleman in olmo nero con top in laccato opaco bronzo, basamento con piedini brown nickel lucido. Specchio Drop con cornice in cuoio 26 invecchiato e specchio bronzato. Boiserie Code in tessuto lino bruciato e profili champagne opaco. Pouf Saint-Germain in tessuto sfoderabile Siro 01 bianco, piedini brown nickel opaco. Tappeto Cannelé.

This and next page: Gentleman chest of drawers in black elm with top in mat lacquer bronzo, base with feet in glossy brown nickel. Drop mirror with frame in hide 26 invecchiato and bronzed mirror. Code wall panelling in fabric lino bruciato with mat champagne profiles. Saint-Germain pouf in removable fabric Siro 01 bianco, mat brown nickel feet. Carpet Cannelé.





GENTLEMAN

Design Marcel Wanders studio, 2020

Struttura e frontali in olmo nero o noce gold.
Top in laccato opaco colori.
Basamento con piedini in metallo
verniciato champagne opaco, brown nickel
opaco o brown nickel lucido.

Structure and fronts in black elm or gold
walnut. Top in mat lacquer colours.
Base with feet in metal painted mat
champagne, mat brown nickel or glossy
brown nickel.

Comodino Night table

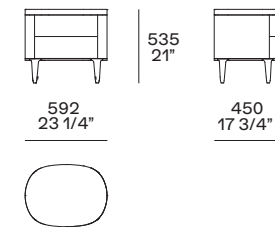

Cassettiera Chest of drawers

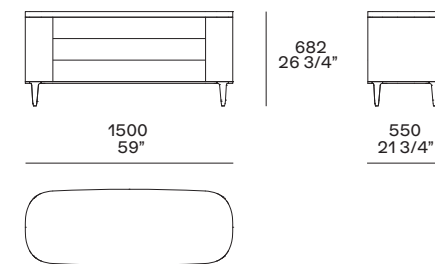



KELLY

Per accompagnare il letto Kelly, Emmanuel Gallina disegna una serie di complementi dalle linee sinuose, delicate ed eleganti. Il comodino e la cassettera, disponibili con piedini o in appoggio a terra, si riconoscono per le forme arrotondate. La cassettera in appoggio è impreziosita da un piccolo piano porta-oggetti in vetro.

To accompany the Kelly bed, Emmanuel Gallina designs a series of complements with sinuous, delicate, and elegant lines. The night table and the chest of drawers, available with or without feet, can be recognized by their rounded shapes. The chest of drawers without feet is embellished by a small glass shelf.





Nella pagina precedente: comodino Kelly in rovere spessart con top laccato lucido caramello e piedini in brown nickel lucido. Letto Kelly, testata imbottita con rivestimento sfoderabile, esterno in pelle Nabuk 02 tortora, interno in pelle Nabuk intrecciata 02 tortora. Base letto in rovere spessart e parte interna con rivestimento non sfoderabile in pelle Nabuk 02 tortora. In questa pagina: cassetiera Kelly in rovere spessart con top in cuoio 29 tortora e piedini in brown nickel lucido. Pouf Gant in pelle non sfoderabile Soft 14 oliva.

Previous page: Kelly night table in spessart oak with caramello glossy lacquered top and feet in glossy brown nickel. Kelly bed, padded headboard with removable covering, outer part in leather Nabuk 02 tortora, inner part in woven leather Nabuk 02 tortora. Bed frame in spessart oak and inner part with non-removable covering in leather Nabuk 02 tortora. This page: Kelly chest of drawers in spessart oak with top in hide 29 tortora and feet in glossy brown nickel. Gant pouf in non-removable leather Soft 14 oliva.

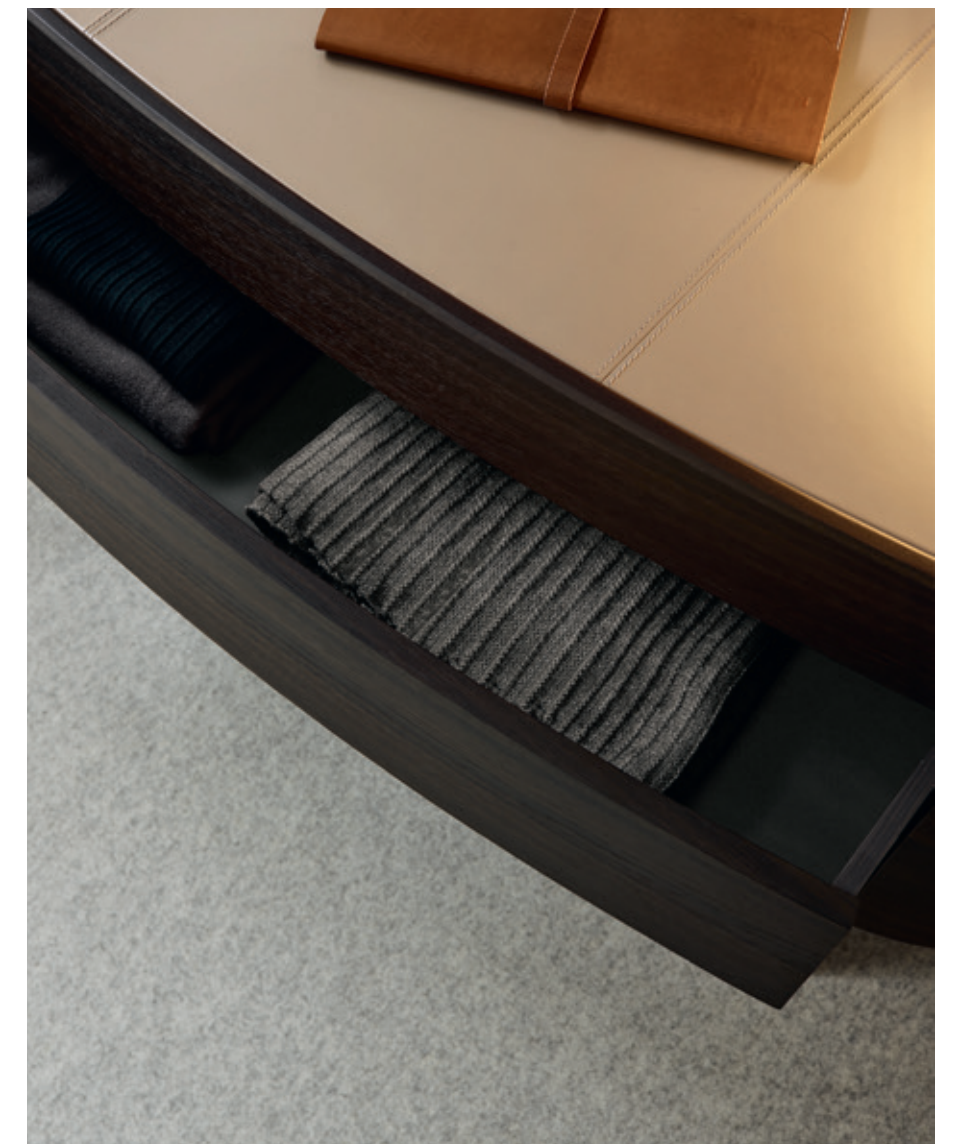

In questa pagina: comodino Kelly in noce gold con top in marmo zecevo levigato. Nella pagina successiva: cassetiera e comodini Kelly nella versione con piedini, in olmo nero con top in marmo calacatta levigato e piedini in brown nickel opaco.

This page: Kelly night table in gold walnut with top in mat zecevo marble. Next page: Kelly chest of drawers and night tables in version with feet, in black elm with top in mat calacatta marble and feet in mat brown nickel.





In questa pagina: cassetiera Kelly in noce gold con top in cuoio 02 nero e mensola superiore in vetro fumé.

This page: Kelly chest of drawers in gold walnut with top in hide 02 nero and top shelf in fumé glass.

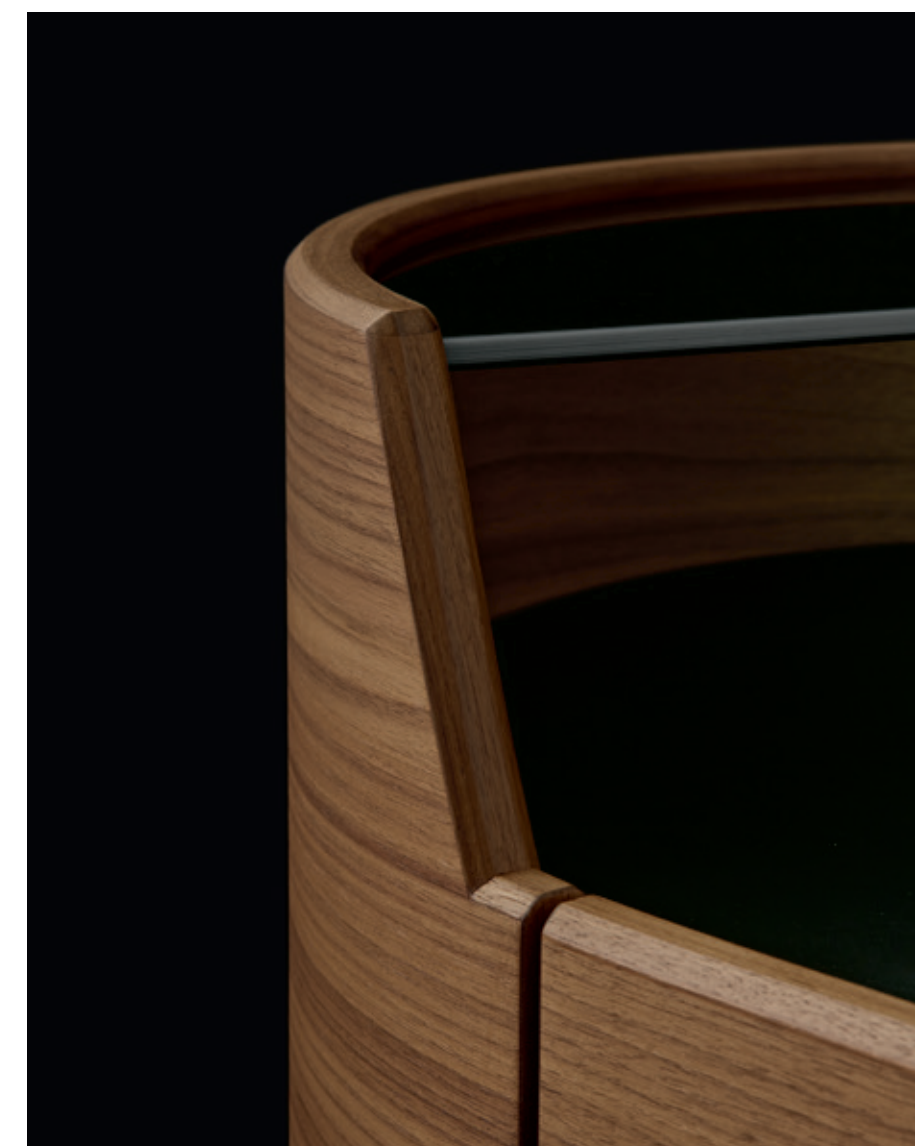



In questa pagina: cassettera Kelly in olmo nero con top in marmo calacatta oro lucido e piedini in brown nickel lucido. Specchio Audrey con cornice in olmo nero, specchio bronzato e cavalletto in brown nickel satinato. Pouf Play in tessuto sfoderabile Sendai 02 tortora. Nella pagina successiva: comodino Kelly in olmo nero con top in cuoio 26 invecchiato. Letto Kelly, testata e base imbottite con rivestimento sfoderabile in tessuto Naxos 16 sabbia, interno testata in tessuto Sendai 01 cenere.

This page: Kelly chest of drawers in black elm with top in glossy calacatta oro marble and feet in glossy brown nickel. Audrey mirror with frame in black elm, bronzed mirror and stand in brushed brown nickel. Play pouf in removable fabric Sendai 02 tortora. Next page: Kelly night table in black elm with top in hide 26 invecchiato. Kelly bed, padded headboard and bed frame with removable covering in fabric Naxos 16 sabbia, inner headboard in fabric Sendai 01 cenere.





KELLY

Design Emmanuel Gallina, 2017-2019

Struttura e frontali in rovere spessart, olmo nero o noce gold. Top in laccato opaco colori, laccato lucido colori, cuoio colori o marmo levigato e lucido (escluso emperador dark). Piedini in metallo finitura champagne opaco, brown nickel opaco o brown nickel lucido.

Cassettiera a terra, con mensola superiore in vetro nella finitura fumé.

Attrezzatura cassettiere: griglia divisoria per primo cassetto.

Structure and fronts in spessart oak, black elm or gold walnut. Top in mat lacquered colours, glossy lacquered colours, hide colours or mat and glossy marble (except emperador dark). Feet in metal with mat champagne, mat brown nickel or glossy brown nickel finish.

Floorstanding chest of drawers with top shelf in glass with fumé finish.

Chest of drawers equipment: partition grid in the first drawer at the top.

Comodino Night table

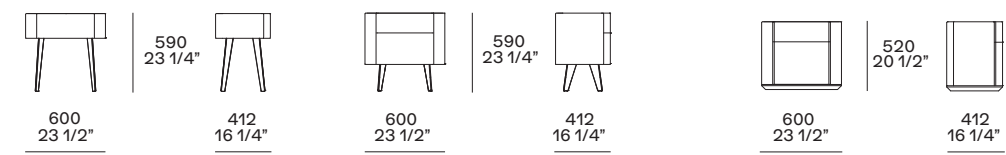

con piedini
with feet

a terra
floorstanding

Cassettiera Chest of drawers

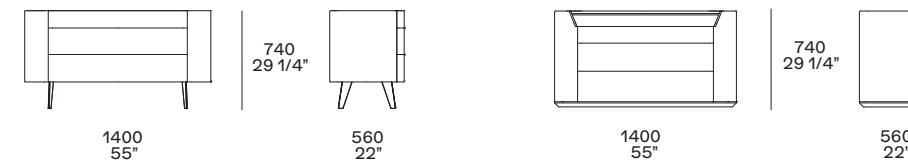

con piedini
with feet

a terra con mensola superiore in vetro
floorstanding with top shelf in glass

ONDA

I comodini e la cassetiera Onda reinterpretano la classica forma cilindrica, dall'aspetto sempre attuale. La struttura, in legno massello, si abbina a top realizzati nello stesso materiale o in finiture ricercate.

The Onda night tables and chest of drawers reinterpret the classic cylindrical shape, a timeless look. The structure, in solid wood, matches with tops made of the same material or with refined finishes.



Nella pagina precedente: cassetiera Onda in rovere spessart con top in marmo calacatta oro lucido e maniglie in cuoio 19 caffè. In questa pagina: comodino Onda in rovere spessart con maniglie in cuoio 02 nero. Letto Onda, rivestimento non sfoderabile con lavorazione capitonné in pelle Invecchiata 880 nero, piedini in brown nickel opaco. Biancheria da letto coordinata in cotone Provence 08 polvere con profilo nero.

Previous page: Onda chest of drawers in spessart oak with top in glossy calacatta oro marble and handles in hide 19 caffè. This page: Onda night table in spessart oak with handles in hide 02 nero. Onda bed, non-removable cover with capitonné manufacturing in leather Invecchiata 880 nero, mat brown nickel feet. Coordinated bed linen in cotton Provence 08 polvere with profile in nero.



In questa pagina: comodini Onda in noce gold con top in marmo zecevo levigato, a sinistra nella versione con due cassetti e maniglie in cuoio 02 nero, a destra nella versione con un cassetto e vano a giorno.

This page: Onda night tables in gold walnut with top in mat zecevo marble, on the left in the version with two drawers and handles in hide 02 nero, on the right in the version with one drawer and open compartment.



In questa pagina: cassetiera Onda in noce gold con top in marmo zecevo levigato e maniglie in cuoio 02 nero.

This page: Onda chest of drawers in gold walnut with top in mat zecevo marble and handles in hide 02 nero.



In questa pagina: comodino Onda in rovere spessart, piano in marmo calacatta oro lucido e maniglie in cuoio 19 caffè. Nella pagina successiva: dettaglio della cassettiera Onda in rovere spessart con top in marmo calacatta oro lucido e maniglie in cuoio 19 caffè. Cassetto superiore attrezzato con griglia divisoria in melamina ardesia e fondo rivestito in cuoio 19 caffè.

This page: Onda night table in spessart oak, top in glossy calacatta oro marble and handles in hide 19 caffè. Next page: detail of Onda chest of drawers in spessart oak with top in glossy calacatta oro marble and handles in hide 19 caffè. Top drawer equipped with partition element in ardesia melamine and bottom covered in hide 19 caffè.

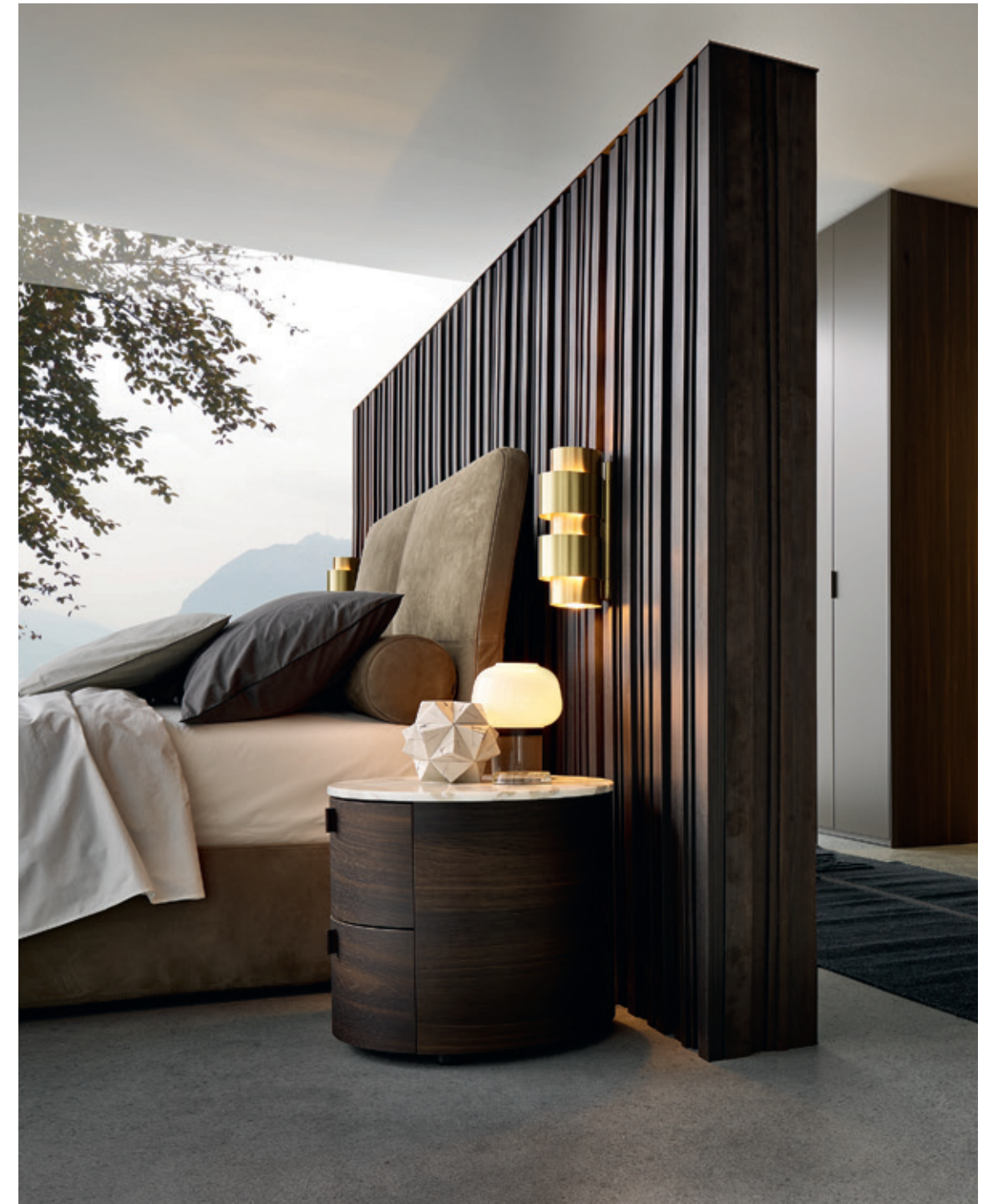



ONDA

Design R&D Poliform, 2014

Struttura e frontali in noce gold o rovere spessart, comodini disponibili anche in laccato opaco colori. Top in noce gold, rovere spessart, laccato opaco colori (solo per comodini), cuoio colori o marmo levigato e lucido (escluso emperador dark). Maniglia in cuoio colori disponibile per cassetiera e per comodino a due cassetti. Attrezzatura cassetiera: griglia divisoria in melamina ardesia per il primo cassetto con fondo rivestito in cuoio colori nel colore della maniglia.

Structure and fronts in gold walnut or spessart oak, night tables also available in mat lacquered colours. Top in gold walnut, spessart oak, mat lacquered colours (only for night tables), hide colours or mat and glossy marble (except emperador dark). Handle in hide colours available for chest of drawers and for night table with two drawers. Chest of drawers equipment: partition grid in the first drawer at the top with drawer bottom covered in hide in the same colour of the handle.

Comodino Night table

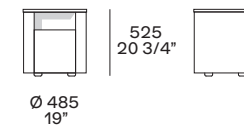

un cassetto e un vano a giorno
one drawer and one open compartment

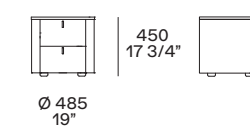

due cassetti
two drawers

Cassetiera Chest of drawers

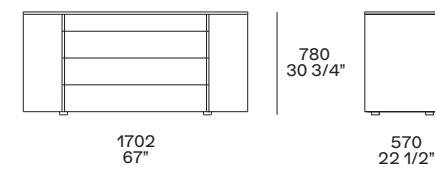

quattro cassetti
four drawers

ABBINABILI

Per il suo design lineare e senza tempo, la serie Abbinabili si affianca a tutti i letti, negli ambienti più diversi. Particolare la lavorazione a 45° di top e cassetti, che si aprono sul lato. La collezione è completata da un settimanale con quattro cassetti e ribalta, che diventa un elegante secrétaire con accessori in essenza.

Thanks to its linear and timeless design, the Abbinabili series matches all beds in the most diverse environments. It features particular, 45-degree details for the tops and drawers, which open on the side. The collection is completed by a four-drawer chest with flap, which becomes an elegant secrétaire with wooden accessories.



Nella pagina precedente: comodini Abbinabili in rovere spessart. Letto Park 1, testata imbottita con rivestimento sfoderabile, esterno in pelle Soft 14 oliva e interno in tessuto Nayoro 02 sabbia. Base letto in brown nickel opaco e pelle sfoderabile Soft 14 oliva. In questa pagina: cassetiera Abbinabili in rovere spessart. Poltrone Stanford in tessuto non sfoderabile Orleans 12 carbone e basamento girevole in brown nickel lucido. Tavolino Soori in metallo finitura bronzo anticato.

Previous page: Abbinabili night tables in spessart oak. Park 1 bed, padded headboard with removable covering, outer part in leather Soft 14 oliva and inner part in fabric Nayoro 02 sabbia. Bed frame in mat brown nickel and removable leather Soft 14 oliva. This page: Abbinabili chest of drawers in spessart oak. Stanford armchairs in non-removable fabric Orleans 12 carbone and swivel base in glossy brown nickel. Soori coffee table in metal with antique bronze finish.



In questa pagina: comodini Abbinabili in laccato lucido e opaco canapa, nelle due dimensioni disponibili. Nella pagina successiva: a sinistra cassetiera Abbinabili a otto cassetti in rovere spessart, a destra cassetiera Abbinabili a quattro cassetti in laccato opaco roccia.

This page: Abbinabili night tables in glossy and mat lacquer canapa, in the two available sizes. Next page: on the left, Abbinabili chest of drawers with eight drawers in spessart oak, on the right, Abbinabili chest of drawers with four drawers in mat lacquer roccia.

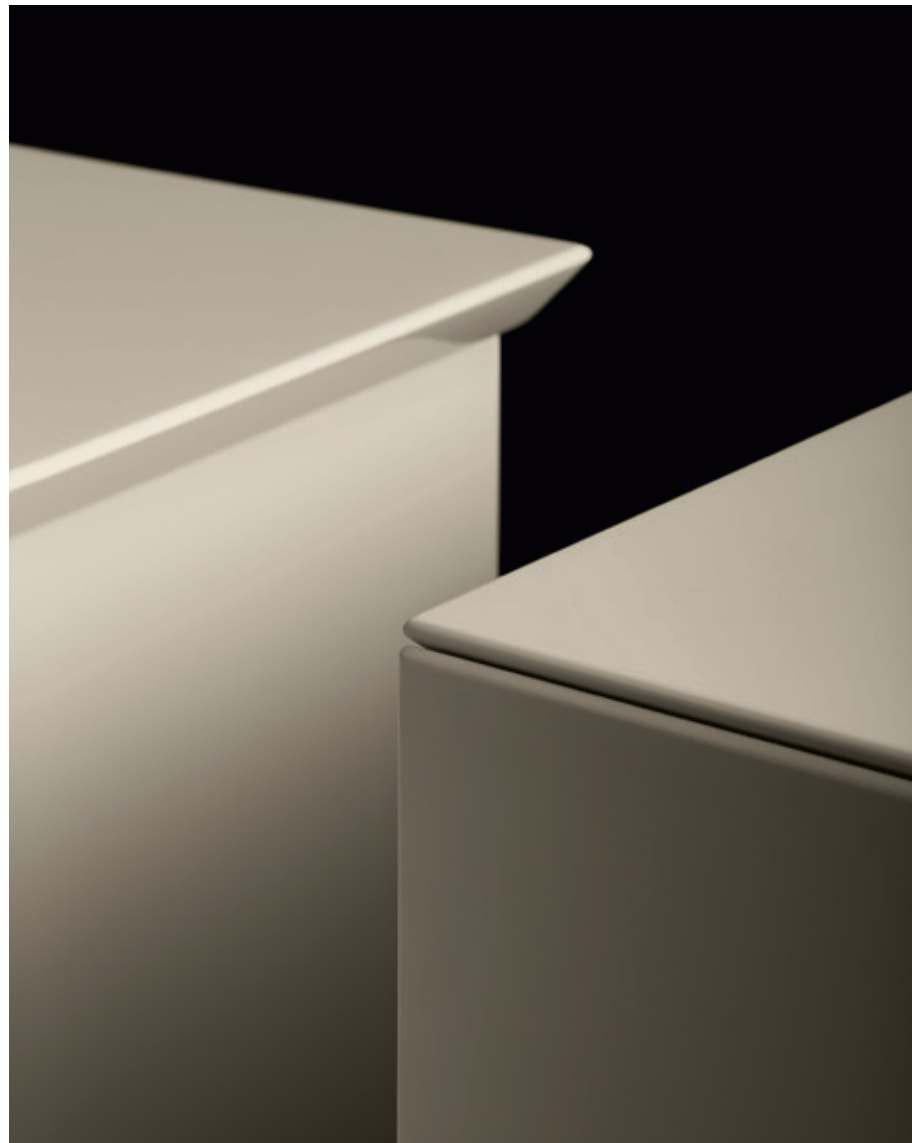





In questa pagina: cassettera Abbinabili con anta ribalta attrezzata in laccato lucido visone. Interno ribalta in noce dogato con vassoio estraibile, divisori e cassetto. Nella pagina successiva: comodini Abbinabili in rovere spessart. Letto Park 1, testata imbottita con rivestimento sfoderabile, esterno in pelle Soft 14 oliva e interno in tessuto Nayoro 02 sabbia. Base letto in brown nickel opaco e pelle sfoderabile Soft 14 oliva. Biancheria da letto coordinata in cotone Provence 03 ghiaccio con profilo roccia, 06 roccia con profilo ghiaccio. Panca Park, seduta con rivestimento sfoderabile in pelle Soft 14 oliva, struttura in brown nickel opaco e pelle sfoderabile Soft 14 oliva. Tavolini Soori in metallo finitura bronzo anticato. Poltrona Stanford in tessuto non sfoderabile Orleans 12 carbone e basamento girevole in brown nickel lucido.

This page: Abbinabili chest of drawers with flap door in glossy lacquer visone. Equipment behind flap door in staved walnut with pull-out tray, partitions and drawer. Next page: Abbinabili night tables in spessart oak. Park 1 bed, padded headboard with removable covering, outer part in leather Soft 14 oliva and inner part in fabric Nayoro 02 sabbia. Bed frame in mat brown nickel and removable leather Soft 14 oliva. Coordinated bed linen in cotton Provence 03 ghiaccio with profile in roccia, 06 roccia with profile in ghiaccio. Park bench, seat with removable covering in leather Soft 14 oliva, structure in mat brown nickel and removable leather Soft 14 oliva. Soori coffee tables in metal with antique bronze finish. Stanford armchair in non-removable fabric Orleans 12 carbone and swivel base in glossy brown nickel.





ABBINABILI

Design R&D Poliform, 1991

Struttura e frontali in laccato opaco colori, laccato lucido colori o rovere spessart. Cassettiera verticale con anta ribalta attrezzata: interno ribalta nelle finiture noce dogato per la versione laccata o laccato opaco moka per la versione in legno. Attrezzatura ribalta: vassoio estraibile, divisori e cassetto.

Structure and fronts in mat lacquered colours, glossy lacquered colours or spessart oak. Vertical chest of drawers with equipped flap door: interior in staved walnut for lacquered version or mat lacquered moka for wooden version. Flap door equipment: pull-out tray, partitions and drawer.

Comodino Night table

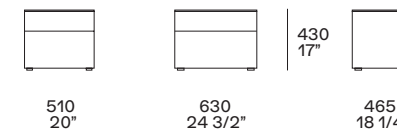

Cassettiera Chest of drawers

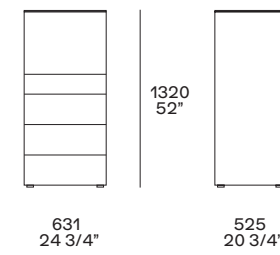
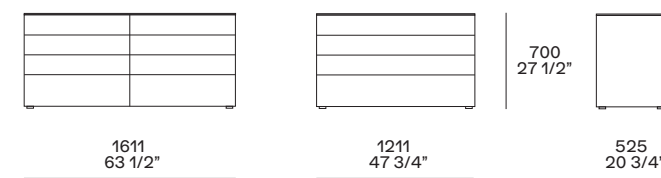

quattro cassetti e ribalta attrezzata
four drawers and equipped flap door

DREAM

Stile essenziale e contemporaneo per la collezione Dream di Marcel Wanders studio, vero e proprio sistema che completa tutti i letti della collezione. Un design sempre attuale, declinato in versione comodino, settimanale e cassetiera, anche con scrittoio in appoggio.

Minimalistic and contemporary style for the Dream collection by Marcel Wanders studio, a true system that completes all the beds in the collection. A timeless design, available in the form of a night table, a seven-drawer chest, and a chest of drawers, also with desk placed on top.



Nella pagina precedente: cassetiera Dream in laccato lucido bianco. In questa pagina: comodini Dream in laccato lucido bianco. Letto Dream con pannellatura a muro e base letto con rivestimento sfoderabile in pelle Soft 07 roccia.

Previous page: Dream chest of drawers in glossy lacquered bianco. This page: Dream night tables in glossy lacquered bianco. Dream bed with wall panelling and bed frame with removable covering in leather Soft 07 roccia.



In questa pagina: comodini Dream in laccato lucido e opaco moka, nelle tre dimensioni disponibili. Nella pagina successiva: cassetiera Dream a sette cassetti in laccato lucido granata, cassetiera Dream a tre cassetti in laccato opaco moka con piano scrittoio in rovere spessart.

This page: Dream night tables in glossy and mat lacquered moka, in the three available sizes. Next page: Dream chest of drawers with seven drawers in glossy lacquered granata, Dream chest of drawers with three drawers in mat lacquered moka with writing desk in spessart oak.





In questa pagina: cassetiera Dream a tre cassetti in laccato opaco roccia. Nella pagina successiva: cassettiere Dream a sette cassetti in laccato opaco visone.

This page: Dream chest of drawers with three drawers in mat lacquered roccia. Next page: Dream chests of drawers with seven drawers in mat lacquered visone.





DREAM

Design Marcel Wanders studio, 2006

Struttura e frontali in laccato opaco colori o laccato lucido colori. Piano scrittoio in laccato opaco colori, laccato lucido colori o rovere spessart.

Structure and fronts in mat lacquered colours or glossy lacquered colours. Writing desk in mat lacquered colours, glossy lacquered colours or spessart oak.

Comodino Night table

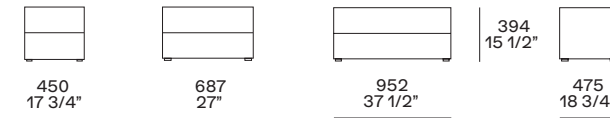

Cassettiera Chest of drawers

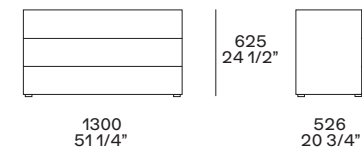

Piano scrittoio Writing desk

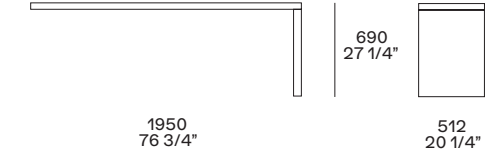

da sormontare alla cassettiera, totalmente o parzialmente
to place above the chest of drawers, totally or partially

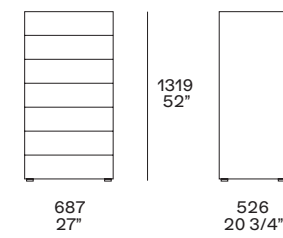



CHLOE

Per accompagnare il letto Chloe, Carlo Colombo progetta una serie di complementi ispirati al disegno della testata, ripiegata verso l'interno. Nei comodini e nella cassetiera Chloe, i fianchi di sostegno in metallo rivestiti in cuoio si trasformano così in un dettaglio iconico che conquista per leggerezza e personalità.

To accompany the Chloe bed, Carlo Colombo designs a series of complements inspired by the design of the headboard, folded inwards. In the Chloe night tables and chest of drawers, the metal support sides covered in hide thus transform into an iconic detail that captivates with its lightness and personality.

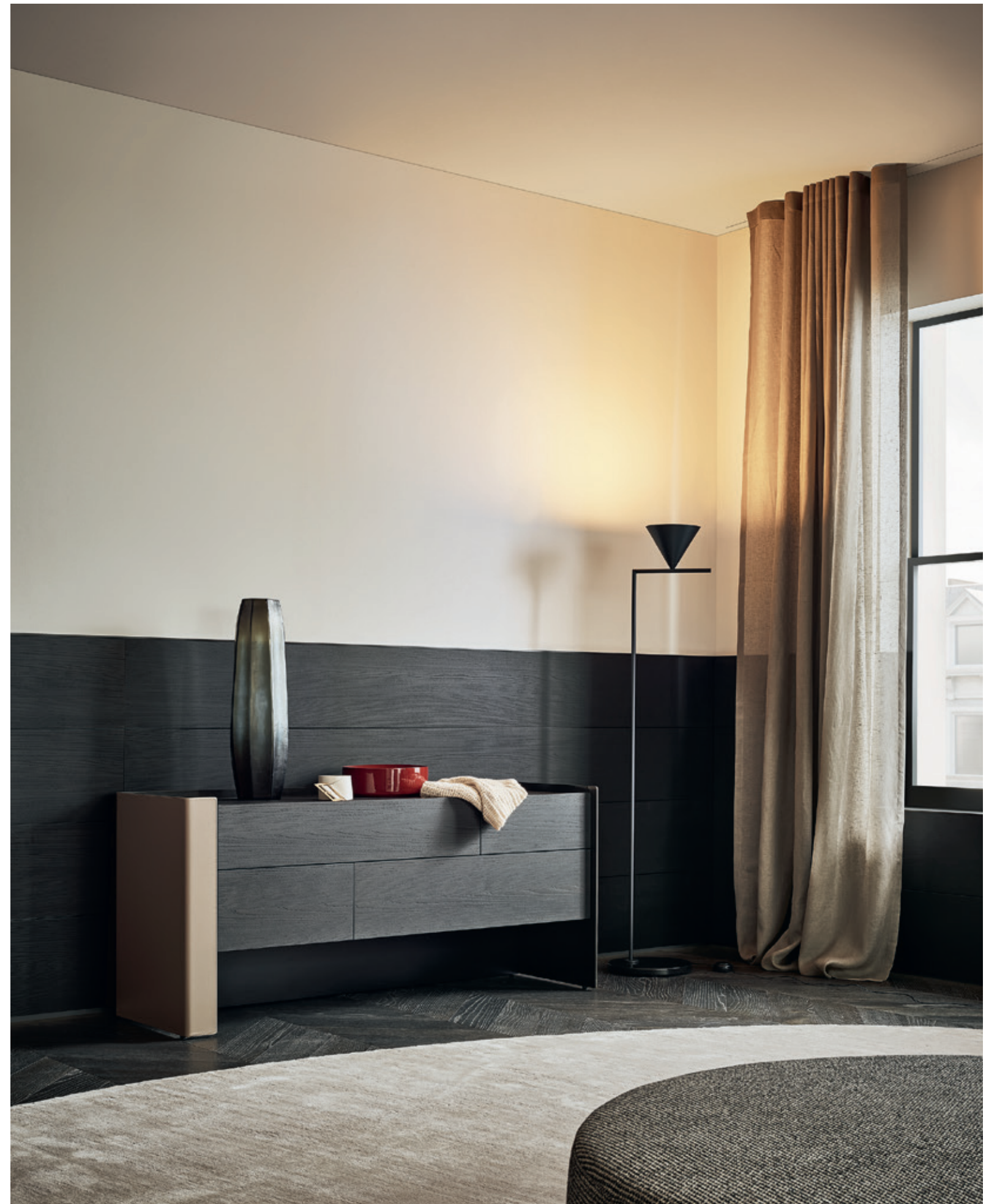



Nella pagina precedente: cassetiera Chloe con struttura esterna in cuoio 29 tortora e interna in brown nickel lucido, cassetti e top in olmo nero. Tappeto Frame perla. In questa pagina: comodini Chloe con struttura esterna in cuoio 29 tortora e interna in brown nickel lucido, cassetti e top in olmo nero. Quid boiserie in olmo nero. Letto Chloe, testata e base imbottite con rivestimento sfoderabile in tessuto Naxos 07 cemento, bordure gros-grain color acciaio.

Previous page: Chloe chest of drawers with outer structure in hide 29 tortora and inner structure in glossy brown nickel, drawers and top in black elm. Carpet Frame perla. This page: Chloe night tables with outer structure in hide 29 tortora and inner structure in glossy brown nickel, drawers and top in black elm. Quid wall panelling in black elm. Chloe bed, padded headboard and bed frame with removable covering in fabric Naxos 07 cemento, grosgrain piping colour acciaio.



In questa pagina: comodini Chloe con struttura esterna in cuoio 26 invecchiato e interna in brown nickel opaco, cassetti in olmo nero e top in marmo levigato sahara noir finitura poliester.

This page: Chloe night tables with outer structure in hide 26 invecchiato and inner structure in mat brown nickel, drawers in black elm and top in mat marble sahara noir with polyester finish.

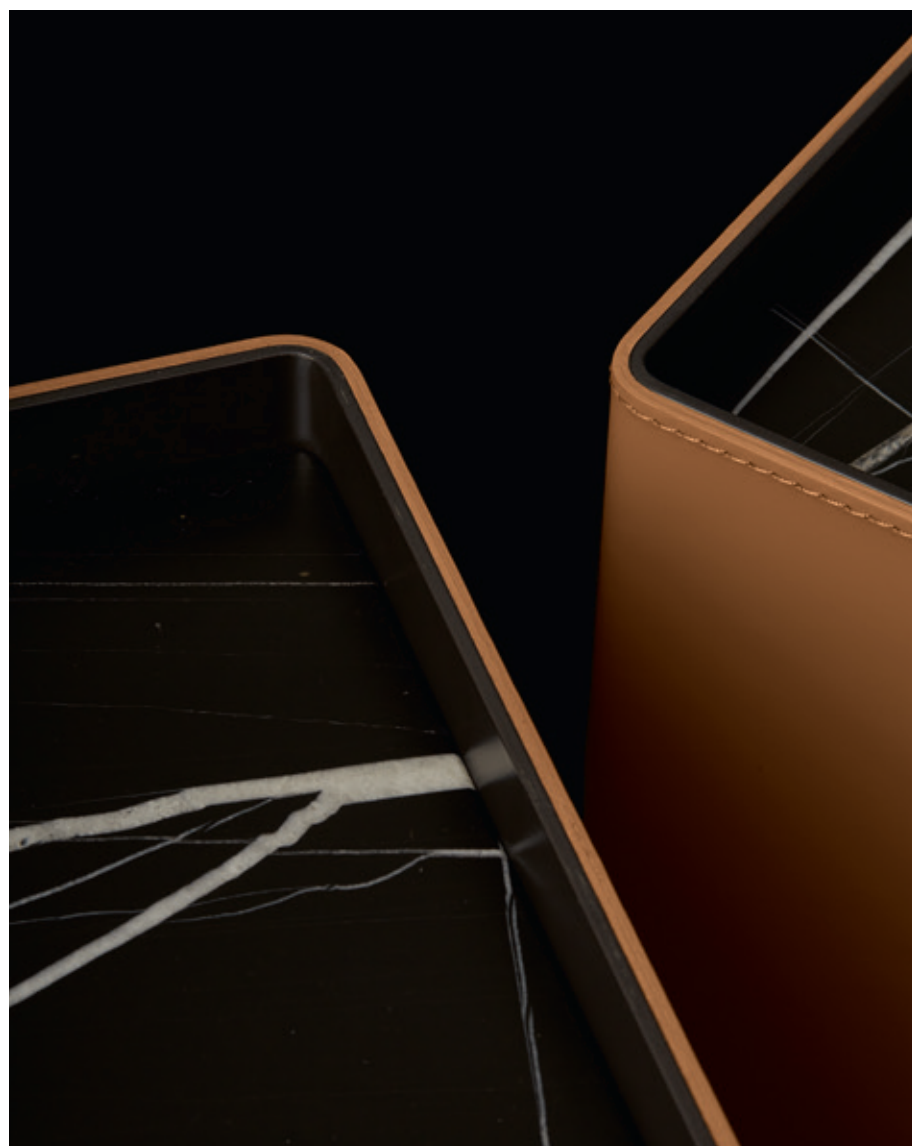



In questa pagina: cassettera Chloe con struttura esterna in cuoio 02 nero e interna in brown nickel lucido, cassetti in olmo nero e top in marmo zecevo levigato. Nella pagina successiva: comodini Chloe con struttura esterna in cuoio 29 tortora e interna in brown nickel lucido, cassetti e top in olmo nero. Quid boiserie in olmo nero. Letto Chloe, testata e base imbottite con rivestimento sfoderabile in tessuto Naxos 07 cemento, bordure gros-grain color acciaio. Biancheria da letto coordinata in cotone Provence 01 bianco con profilo nero. Coperta Linus granata. Poltrona Mad Chair in tessuto sfoderabile Nancy 125 sabbia, basamento girevole in brown nickel lucido. Tappeto Soft grigio.

This page: Chloe chest of drawers with outer structure in hide 02 nero and inner structure in glossy brown nickel, drawers in black elm and top in mat zecevo marble. Next page: Chloe night tables with outer structure in hide 29 tortora and inner structure in glossy brown nickel, drawers and top in black elm. Quid wall panelling in black elm. Chloe bed, padded headboard and bed frame with removable covering in fabric Naxos 07 cemento, grosgrain piping colour acciaio. Coordinated bed linen in cotton Provence 01 bianco with profile in nero. Blanket Linus granata. Mad Chair armchair in removable fabric Nancy 125 sabbia, swivel base in glossy brown nickel. Carpet Soft grigio.





CHLOE

Design Carlo Colombo, 2017

Struttura in alluminio, esterno rivestito in cuoio colori e interno in brown nickel opaco o lucido. Frontali cassetti in olmo nero. Top in olmo nero o marmo levigato e lucido (escluso emperador dark).

Structure in aluminium, outer part covered in hide in the available colours and inner part in mat or glossy brown nickel. Drawer fronts in black elm. Top in black elm or mat and glossy marble (except emperador dark).

Comodino Night table

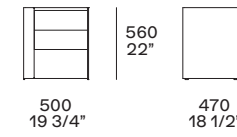

sinistro - due cassetti
left - two drawers

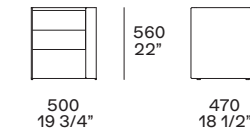

destra - due cassetti
right - two drawers

Cassettiera Chest of drawers

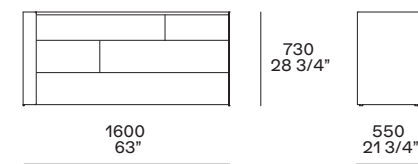

quattro cassetti
four drawers

YOU

Un'estetica impeccabile e una lavorazione di grande finezza: la collezione You è un'opera di ebanisteria ripensata in chiave contemporanea. La caratteristica stondatura frontale è ripresa anche sul retro, rendendo cassettiere e comodini ideali anche a centrostanza.

An impeccable style and workmanship of great finesse: the You collection is a cabinetry work redesigned with a contemporary interpretation. The characteristic frontal rounding is also on the back, making chests of drawers and night tables ideal even in the middle of the room.





Nella pagina precedente: cassetiera You in rovere spessart. Pouf Dune in tessuto sfoderabile Rabat 412 cemento. In questa pagina: comodino You in rovere spessart. Letto Arca con testata imbottita trapuntata, rivestimento sfoderabile in pelle Nabuk 01 latte. Biancheria da letto coordinata in cotone Provence 06 roccia con profilo bianco e 03 ghiaccio con profilo bianco.

Previous page: You chest of drawers in spessart oak. Dune pouf in removable fabric Rabat 412 cemento. This page: You night table in spessart oak. Arca bed with quilted padded headboard, removable covering in leather Nabuk 01 latte. Coordinated bed linen in cotton Provence 06 roccia with profile in bianco and nero and 03 polvere with profile in bianco.

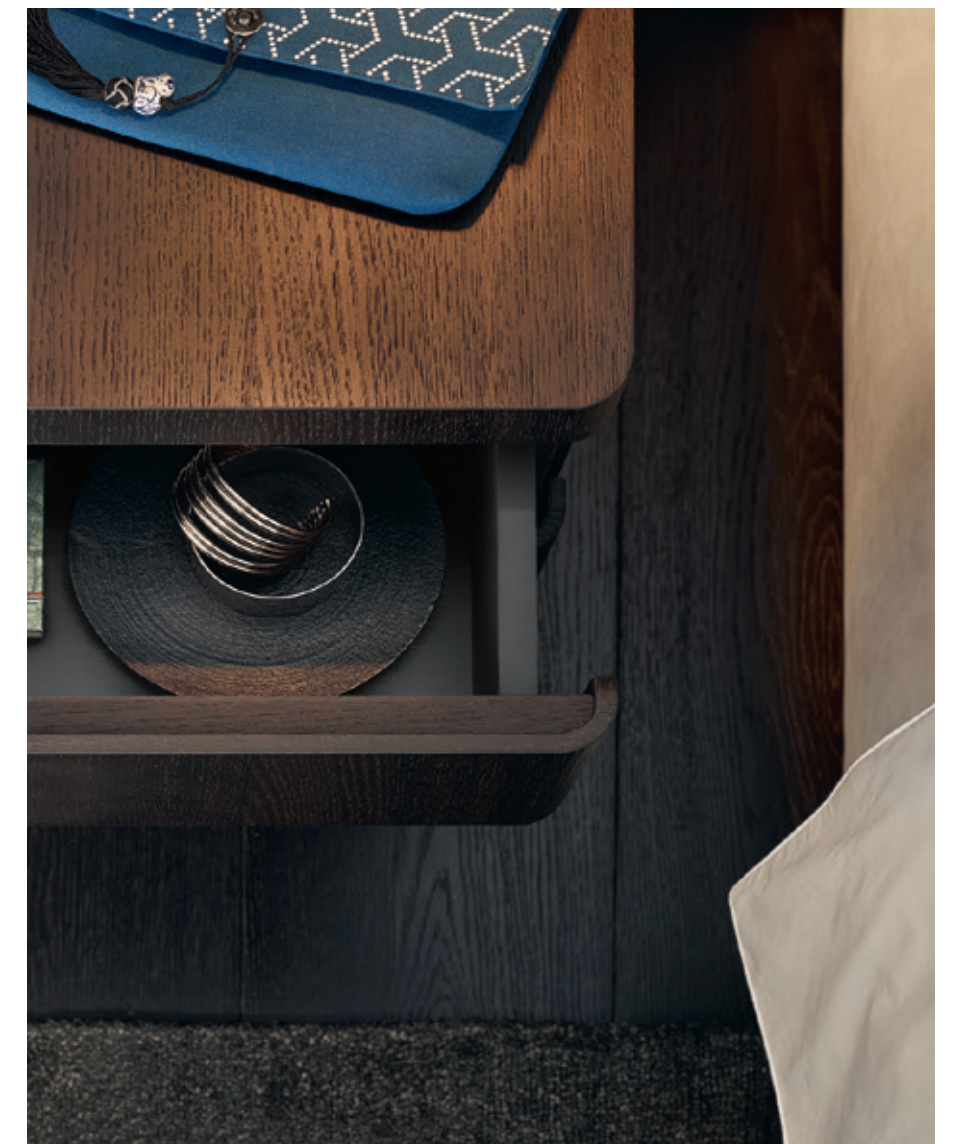

In questa pagina: comodino You in rovere spessart. Nella pagina successiva: cassetiera You in rovere spessart.

This page: You night table in spessart oak. Next page: You chest of drawers in spessart oak.







In questa pagina: cassetiera You in rovere spessart. Nella pagina successiva: dettaglio del cassetto con le estremità del frontale arrotondate che ne consentono l'apertura.

This page: You chest of drawers in spessart oak. Next page: detail of drawer with rounded front ends to allow opening.

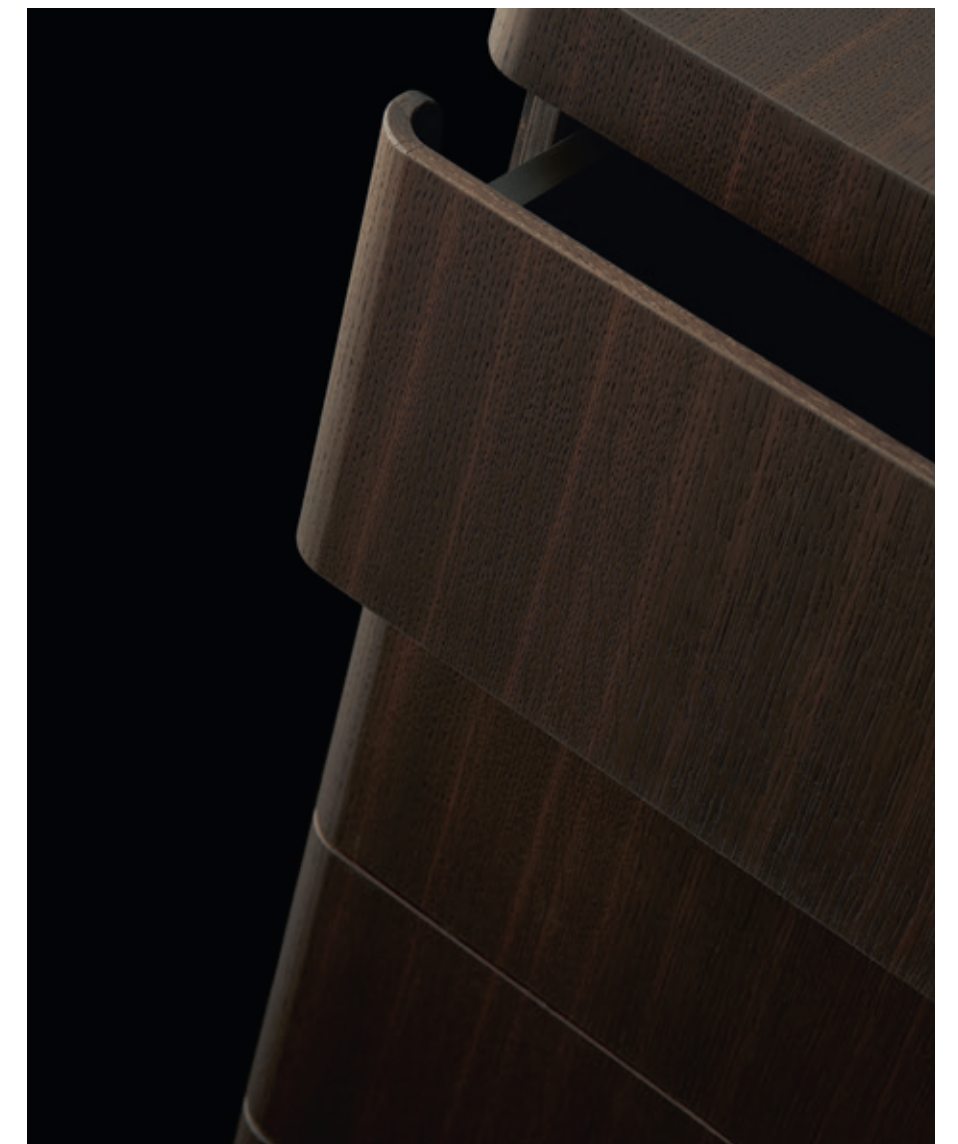

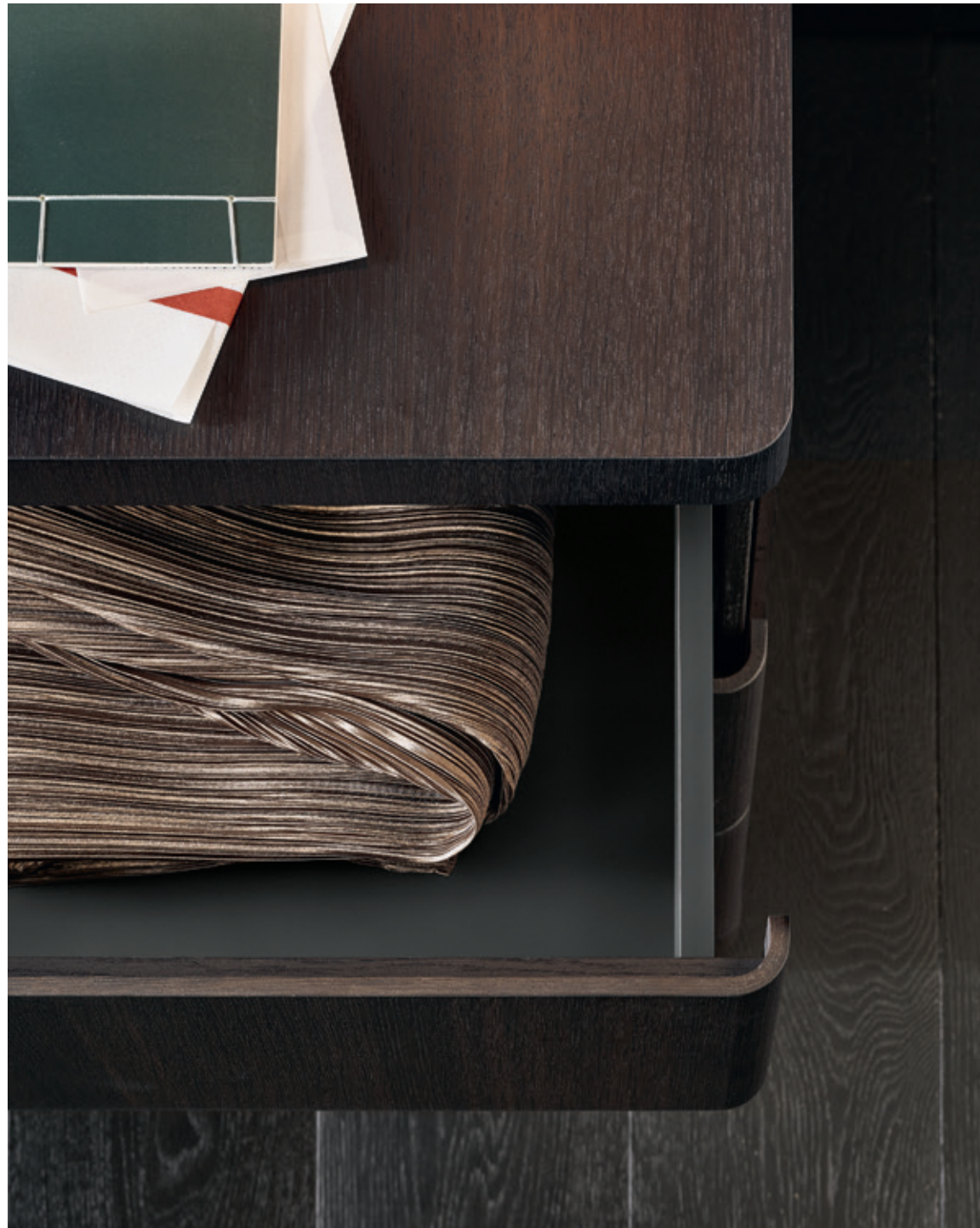

YOU

Design D&T, 2010

Struttura in rovere spessart.
Frontali cassetti in rovere spessart.

Structure in spessart oak.
Drawer fronts in spessart oak.

**Comodino
Night table**

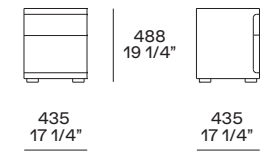

**Cassettiera
Chest of drawers**

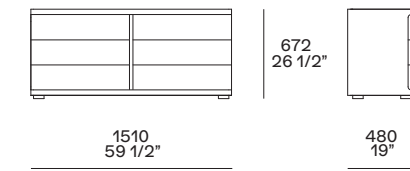
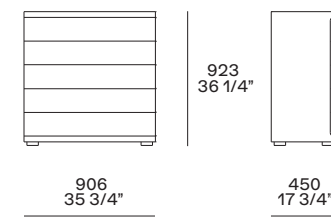

MIRRORS

Complementi immancabili nella zona notte, gli specchi riflettono l'ambiente circostante e la luce, oltre che l'immagine di chi li guarda. Funzionalità ed estetica si compenetrano in una collezione dallo stile essenziale dove ad attirare l'attenzione sono dettagli preziosi e finiture ricercate.

Essential complements of the night area, mirrors reflect not only your image, but the surrounding environment and the light. Functionality and style combine in a collection with a minimalist look where precious details and refined finishes captivate your attention.

MIRRORS

DROP	275
CIRCLE	285
AUDREY	295
SARA	305

DROP

Elegante e prezioso, Drop è uno specchio rotondo dalle dimensioni generose. È caratterizzato dalla cornice in cuoio, che incorpora la cinghia con cui si appende alla parete.

Elegant and precious, Drop is a generously sized round mirror. It features a leather frame that incorporates the strap used to hang it on the wall.



Nella pagina precedente e in chiusura: specchio Drop con cornice in cuoio 26 invecchiato e specchio bronzato. Cassettiera Gentleman in olmo nero con top in laccato opaco bronzo, basamento con piedini brown nickel lucido. Pouf Saint-Germain in tessuto sfoderabile Siro 01 bianco, piedini brown nickel opaco. Tavolino Koishi con piano in marmo zecevo levigato e struttura in verniciato brunito. Boiserie Code in tessuto lino bruciato e profili champagne opaco. Tappeto Cannelé. In questa pagina: specchio Drop con cornice in cuoio 02 nero e specchio bronzato.

Previous page and closing page: Drop mirror with frame in hide 26 invecchiato and bronzed mirror. Gentleman chest of drawers in black elm with top in mat lacquer bronzo, base with feet in glossy brown nickel. Saint-Germain pouf in removable fabric Siro 01 bianco, mat brown nickel feet. Koishi coffee table with top in mat marble zecevo and painted brunito structure. Code wall panelling in fabric lino bruciato with mat champagne profiles. Carpet Cannelé. This page: Drop mirror with frame in hide 02 nero and bronzed mirror.





In questa pagina: specchio Drop con cornice in cuoio 26 invecchiato e specchio bronzato. Sotto: dettaglio del gancio in ottone lucido.

This page: Drop mirror with frame in hide 26 invecchiato and bronzed mirror. Below: close up of the hook in polished brass.





DROP

Design R&D Poliform, 2021

Specchio da parete comprensivo di supporto per fissaggio a muro. Cornice in metallo rivestita in cuoio colori. Gancio e particolari in ottone lucido. Colore specchio bronzato.

Wall mirror inclusive of wall fixing support. Frame in metal covered in hide in the available colours. Hook and details in polished brass. Mirror colour bronzed.

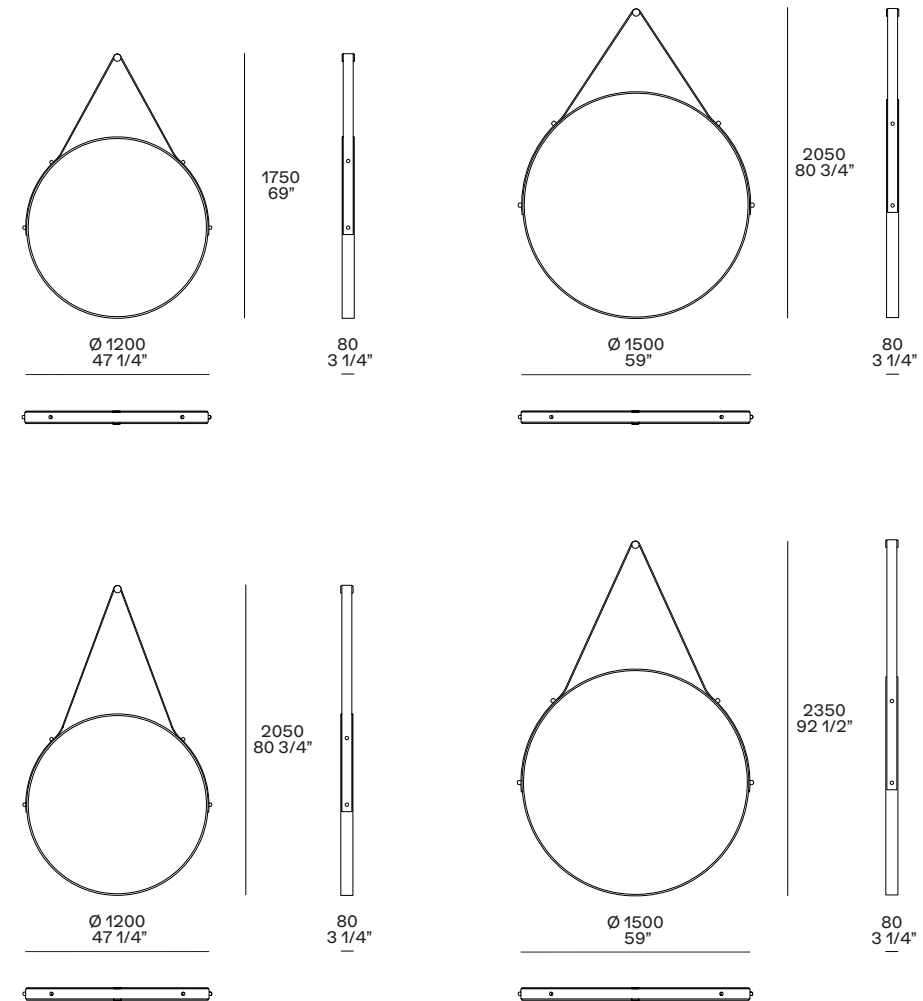

CIRCLE

La perfezione geometrica del cerchio incontra l'eleganza della cornice in cuoio: nasce così Circle, uno specchio da parete che arreda con semplicità ogni ambiente.

The geometric perfection of the circle meets the elegance of the hide frame: thus rises Circle, a wall mirror that furnishes any environment with simplicity.



Nella pagina precedente: specchio Circle con cornice in cuoio 02 nero e specchio bianco. Madia Code in noce gold con top in marmo zecevo levigato, vani a giorno in laccato opaco ottone. Basamento con piedini champagne opaco. Boiserie Code in tessuto lino chiaro e profili champagne opaco. Pouf New York con rivestimento sfoderabile in tessuto Antea 05 terra di siena. In questa pagina: specchio Circle con cornice in cuoio 26 invecchiato e specchio bianco.

Previous page: Circle mirror with frame in hide 02 nero and white mirror. Code sideboard in gold walnut with top in mat marble zecevo, ottone mat lacquered open compartments. Base with mat champagne feet. Code wall panelling in fabric lino chiaro and mat champagne profiles. New York pouf with removable cover in fabric Antea 05 terra di siena. This page: Circle mirror with frame in hide 26 invecchiato and white mirror.





In questa pagina: specchio Circle con cornice in cuoio 02 nero e specchio bianco. Nella pagina successiva: specchio Circle con cornice in cuoio 26 invecchiato e specchio bianco. Cabina armadio Senzafine in nobilitato olmo con fianchi a telaio in champagne opaco e schienali in metacrilato roller latte. Cassettiere a vetrina laccato opaco champagne e cassetti inferiori in vetro riflettente fumé con maniglia Track champagne opaco.

This page: Circle mirror with frame in hide 02 nero and white mirror. Next page: Circle mirror with frame in hide 26 invecchiato and white mirror. Senzafine walk-in closet in elm melamine with frame sides in mat champagne and backs in roller latte methacrylate. Display case chest of drawers mat lacquered champagne and lower drawers in fumé reflecting glass with mat champagne Track handle.





CIRCLE

Design R&D Poliform, 2019

Specchio da parete comprensivo di supporto per fissaggio a muro. Cornice in metallo rivestita in cuoio colori. Colore specchio bianco.

Wall mirror inclusive of wall fixing support. Metal frame covered in hide in the available colours. Mirror colour white.

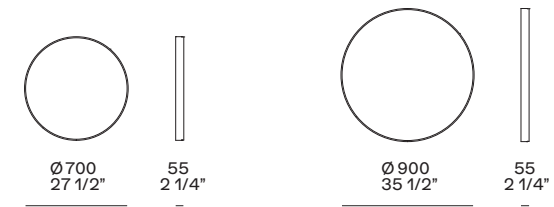

AUDREY



Audrey è uno specchio romantico e minimale, disegnato da Emmanuel Gallina. La versione a parete ne esalta i contorni morbidi e la cornice sottile, mentre la versione da appoggio a terra mette in luce la particolare lavorazione del retro e il raffinato supporto in metallo. Lo specchio è disponibile nelle due versioni chiara o bronzata.

Audrey is a romantic and minimalistic mirror, designed by Emmanuel Gallina. The wall version enhances the soft edges and the thin frame, while the floor version highlights the particular detail work of the back and the refined metal support. The mirror is available in the light or the bronze version.



Nella pagina introduttiva: specchio Audrey con cornice in olmo nero, specchio bronzato e cavalletto in champagne satinato. Nella pagina precedente: specchio Audrey con cornice in olmo nero, specchio bronzato e cavalletto in brown nickel satinato. Cassettiera Kelly in olmo nero con top in marmo calacatta oro lucido e piedini in brown nickel lucido. Pouf Play in tessuto sfoderabile Sendai 02 tortora. In questa pagina: specchio Audrey con cornice in olmo nero e specchio bianco.

Introductory page: Audrey mirror with frame in black elm, bronzed mirror and stand in brushed champagne. Previous page: Audrey mirror with frame in black elm, bronzed mirror and stand in brushed brown nickel. Kelly chest of drawers in black elm with top in glossy calacatta oro marble and feet in glossy brown nickel. Play pouf in removable fabric Sendai 02 tortora. This page: Audrey mirror with frame in black elm and white mirror.



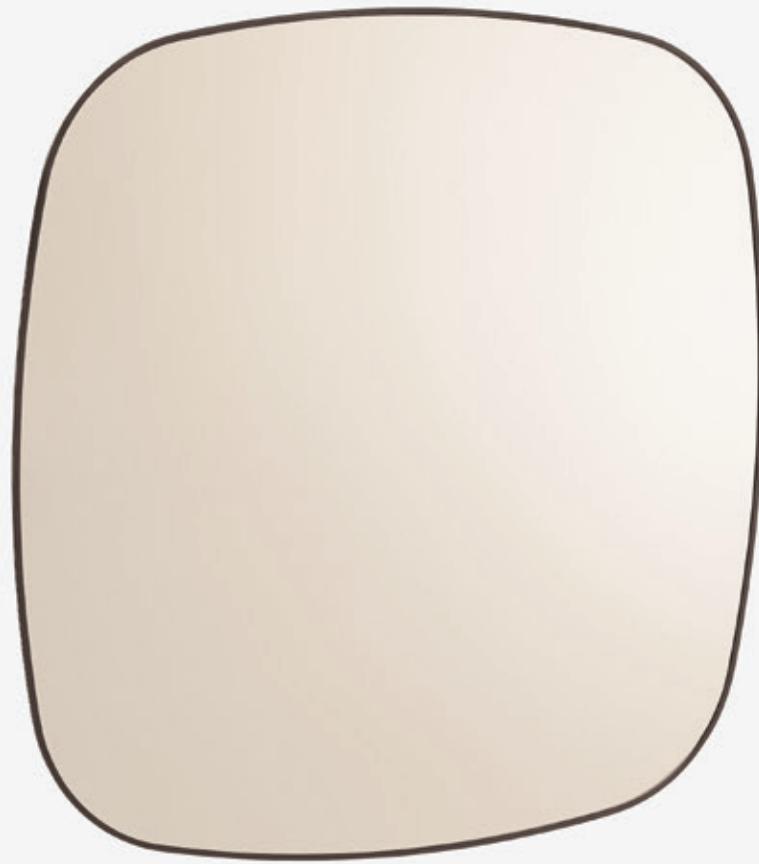

In questa pagina: specchio Audrey con cornice in olmo nero e specchio bronzato. Nella pagina successiva: specchio Audrey con cornice in olmo nero, specchio bronzato e cavalletto in brown nickel satinato. Pouf Onda rivestimento non sfoderabile in velluto Persia 1402 muschio. Tappeto Frame gold.

This page: Audrey mirror with frame in black elm and bronzed mirror. Next page: Audrey mirror with frame in black elm, bronzed mirror and stand in brushed brown nickel. Onda pouf with non-removable covering in velvet Persia 1402 muschio. Carpet Frame gold.





AUDREY

Design Emmanuel Gallina, 2018

Specchio da terra con cavalletto o da parete
comprensivo di supporto per fissaggio
a muro. Struttura in legno con cornice in
massello, finitura olmo nero.
Colore specchio bronzato o bianco.
Cavalletto in metallo brown nickel satinato
o champagne satinato.

Floorstanding mirror with stand or wall-
mounted inclusive of wall fixing support.
Wood structure with solid wood frame,
black elm finish.
Mirror colour bronzed or white.
Stand in brushed brown nickel or brushed
champagne metal.

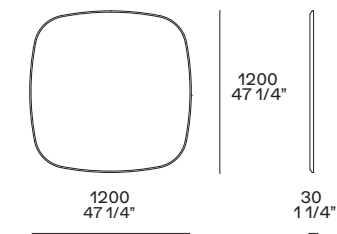
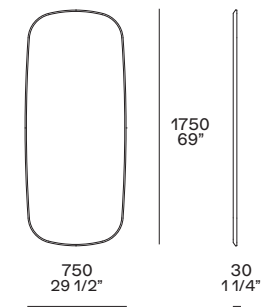
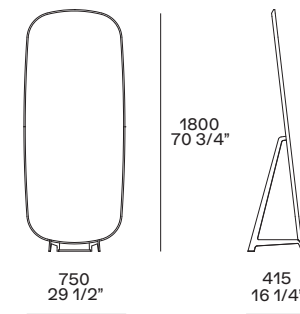

fissaggio a muro, orizzontale o verticale
wall fixing, horizontal or vertical

SARA

Flaviano Capriotti riduce lo specchio alla più pura essenzialità. Il risultato è la massima pulizia della superficie riflettente, circondata da una cornice sottile che regala stili diversi a seconda della finitura scelta – metallica, laccata o in cuoio.

Flaviano Capriotti reduces the mirror to the purest minimalism. The result is maximum cleanliness of the reflective surface, surrounded by a thin frame that offers different styles depending on the chosen finish – metal, lacquer or hide.



Nella pagina precedente: specchio Sara con cornice in brown nickel opaco e specchio bianco. In questa pagina: specchio Sara con cornice in cromo nero satinato e specchio bianco.

Previous page: Sara mirror with frame in mat brown nickel and white mirror. This page: Sara mirror with frame in brushed black chrome and white mirror.



In questa pagina e nella successiva: specchio Sara con cornice in cuoio 29 tortora, cuciture a vista e specchio bianco.

This and next page: Sara mirror with frame in hide 29 tortora, visible stitching and white mirror.

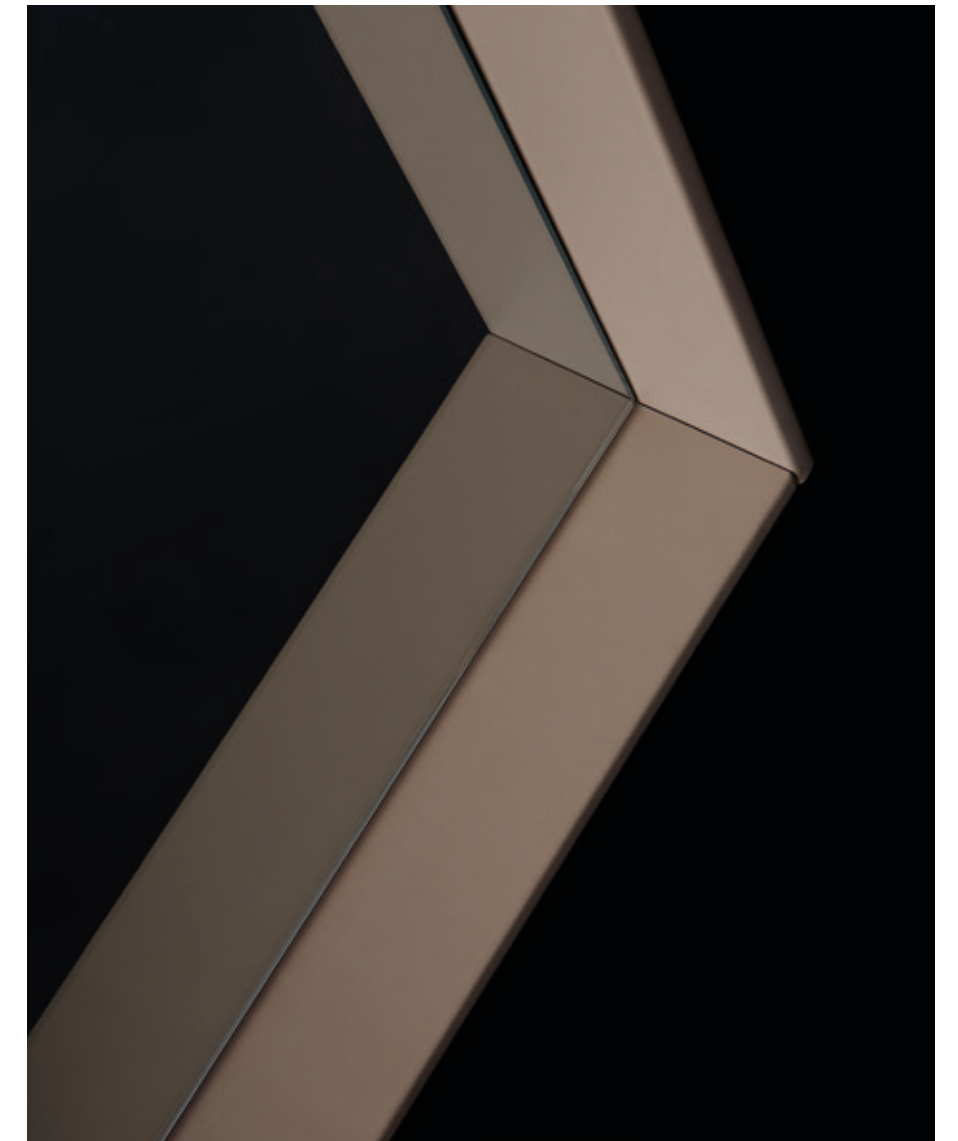

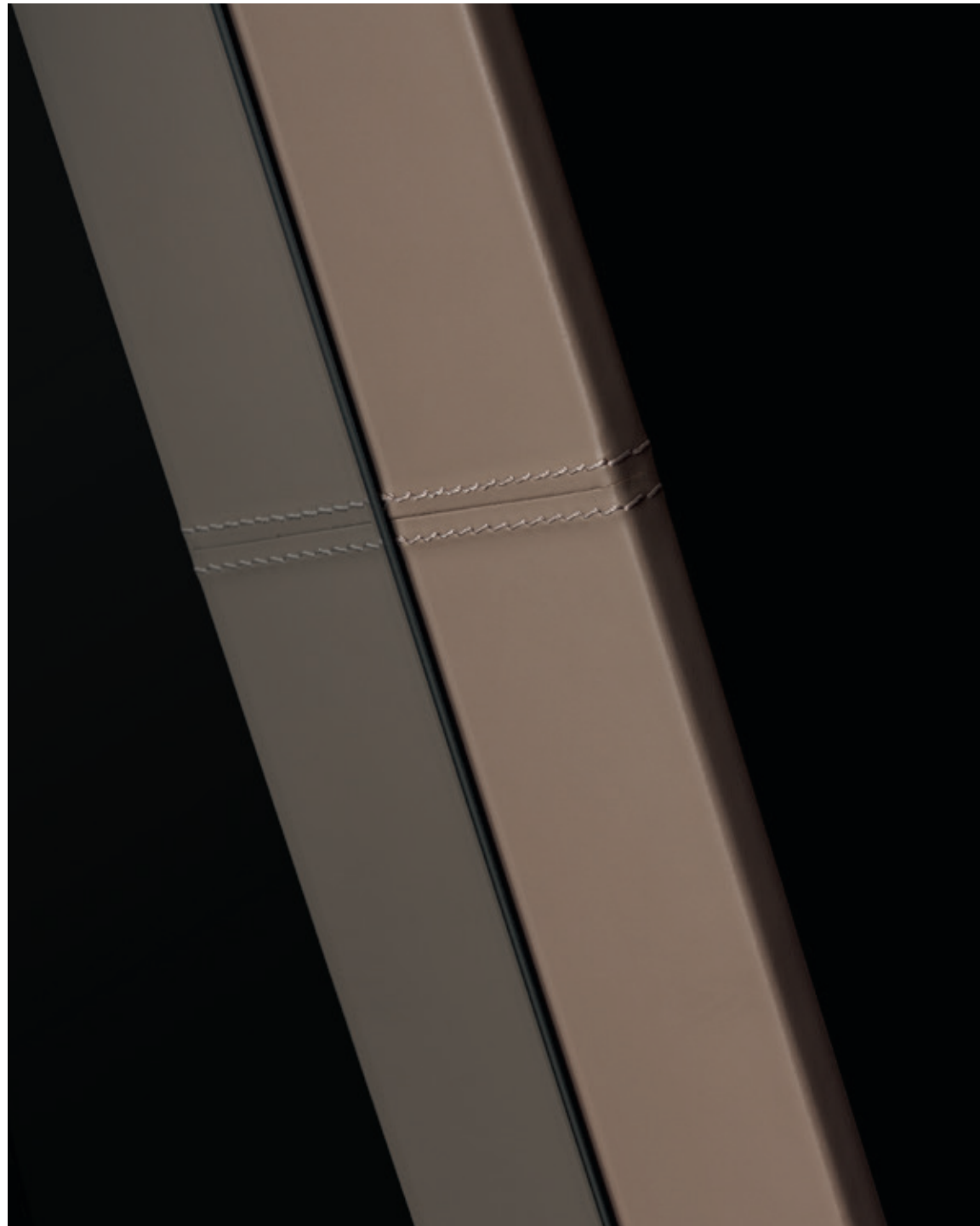

SARA

Design Flaviano Capriotti, 2010

Specchio da parete comprensivo di supporto per fissaggio a muro o di gommini antiscivolo per posizionamento a terra. Profilo in alluminio laccato opaco colori, brown nickel opaco o lucido, champagne opaco, cromo nero satinato o rivestito in cuoio colori. Colore specchio bianco.

Wall mirror inclusive of wall fixing support or non-slip rubber supports for floor positioning. Aluminium profile in mat lacquered colours, mat or glossy brown nickel, mat champagne, brushed black chrome or covered in hide in the available colours. Mirror colour white.

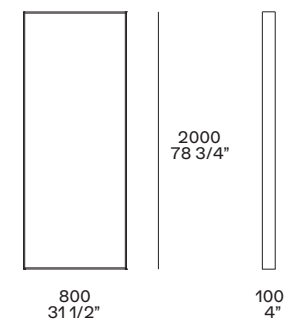

BED ACCESSORIES

RETI BEDSTEADS	316
MATERASSI MATTRESSES	318
RIVESTIMENTI MATERASSI MATTRESS COVERS	320
COPRIRETE E TOPPER BEDSTEAD COVER AND TOPPER	321
INSERTI GUANCIALE E RULLO PILLOW INSERTS AND ROLL-CUSHION	322
INSERTI PIUMINO DUVET INSERTS	323
COLLEZIONE BIANCHERIA LINEN COLLECTION	324
COPERTA LINUS LINUS BLANKET	325

RETI BEDSTEADS

Le reti Poliform sono progettate per garantire il corretto equilibrio fra elasticità di movimento e rigidità di supporto. Tutte le reti sono in faggio con doghe flessibili.

Poliform bedsteads are projected to grant the best balance of firm support and flexibility in the movements. All the bedsteads are in beech wood with flexible slats.

Rete fissa Fixed bedstead



In faggio con doghe flessibili montate ad incastro nel telaio perimetrale. Nella zona lombare le doghe sono raddoppiate per assicurare un maggiore sostegno e sono dotate di cursori per regolare la flessibilità. Dimensioni mm: l 800-900-1000-1400-1600-1800-2000 p 2000-2100 h 55. Queen size l 1525 x p 2030. King size l 1930 x p 2030. Bedstead in beech wood with flexible slats joint assembled in the perimeter frame. In the pelvis area, the slats are doubled to grant the best support and are provided of sliders to adjust the flexibility. Dimensions in: w 31 1/2"-35 1/2"-39 1/4"-55" 63"-70 3/4"-78 3/4" x d 78 3/4"-82 3/4" h 2 1/4". Queen size w 60" x d 80". King size w 76" x d 80".

rete fissa ridotta per letto Kelly e Park 1 / customized fixed bedstead for bed Kelly and Park 1

Contenitore con rete ribaltabile Container box with tip-up bedstead



Rete con telaio in metallo e movimento assistito da ammortizzatori. Doghe flessibili in faggio montate ad incastro nel telaio. Dimensioni mm: l 1000-1400-1600-1800-2000 x p 2000-2100. Queen size l 1525 x p 2030. King size l 1930 x p 2030. Bedstead with metal frame, movement assisted by shock absorbers. Flexible slats in beech wood joint assembled in the frame. Dimensions in: w 39 1/4"-55"-63"-70 3/4" 78 3/4" x d 78 3/4"-82 3/4". Queen size w 60" x d 80". King size w 76" x d 80".

Rete anatomica Anatomic bedstead

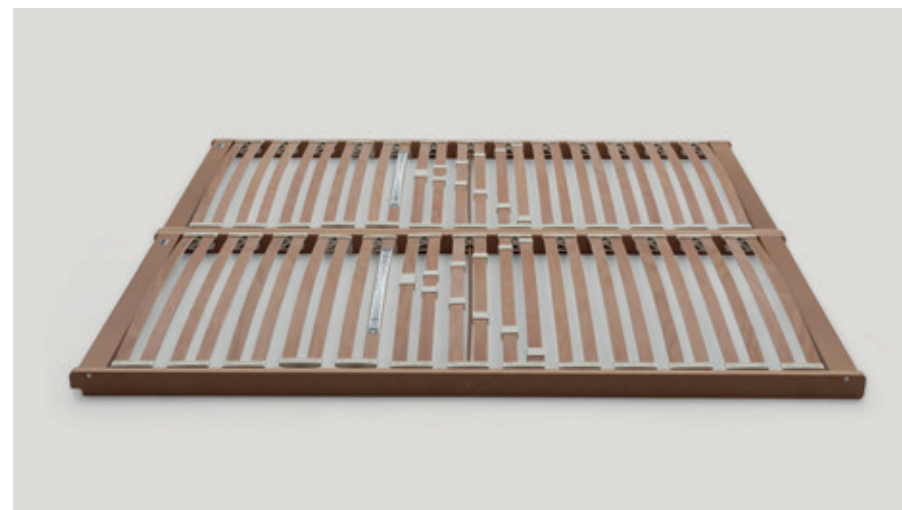

In faggio con doghe flessibili montate a coppia su supporti in gomma, con movimento indipendente, distanziate per facilitare l'aerazione del materasso. Nella zona lombare le doghe sono raddoppiate per assicurare un maggiore sostegno e sono dotate di cursori per regolare la flessibilità. Dimensioni mm: l 800-900-1000 p 2000-2100 h 70. Bedstead in beech wood with flexible slats mounted in pairs on rubber supports, with independent movement, spaced to facilitate the ventilation of the mattress. In the pelvis area, the slats are doubled to grant the best support and are provided of sliders to adjust the flexibility. Dimensions in: w 31 1/2"-35 1/2"-39 1/4" d 78 3/4"-82 3/4" h 2 3/4".

Rete anatomica con movimento manuale Anatomic bedstead with manual movement



In faggio con doghe flessibili montate a coppia su supporti in gomma. Nella zona lombare le doghe sono raddoppiate per assicurare un maggiore sostegno e sono dotate di cursori per regolare la flessibilità. Movimento manuale della sola testiera. Consigliato l'utilizzo di materassi singoli e preferibilmente in lattice. Dimensioni mm: l 800-900-1000 p 2000-2100 h 70. Bedstead in beech wood with flexible slats mounted in pairs on rubber supports. In the pelvis area, the slats are doubled to grant the best support and are provided of sliders to adjust the flexibility. Manual headboard movement. We recommend the use of single and preferably latex mattresses. Dimensions in: w 31 1/2"-35 1/2"-39 1/4" d 78 3/4"-82 3/4" h 2 3/4".

MATERASSI MATTRESSES

Comfort

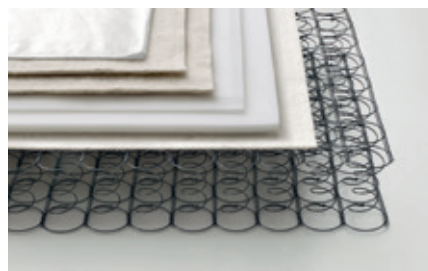

Materasso a molle con imbottitura di irrigidimento in feltro agugliato, termofissato, fonoassorbente e in poliuretano espanso. Rivestimenti: non sfoderabile in 100% raso viscosa ritorto con trattamento antiacaro Sanitized® o in tessuto sfoderabile antimicrobico Amicor Pure™. Spring mattress with stiffening padding in needle-punched, heat-set, sound absorbing felt and in expanded polyurethane. Covers: non-removable in 100% twisted viscose satin with anti-mite treatment Sanitized® or in removable antimicrobial fabric Amicor Pure™. h 160-180 / 6 1/4"-7".

Ortopedico

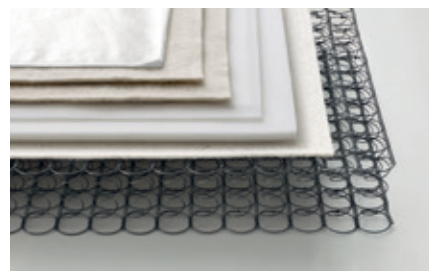

Materasso a molle ad alta densità con imbottitura di irrigidimento in feltro agugliato, termofissato, fonoassorbente e in poliuretano espanso. Rivestimenti: non sfoderabile in 100% raso viscosa ritorto con trattamento antiacaro Sanitized® o in tessuto sfoderabile antimicrobico Amicor Pure™. High-density spring mattress with stiffening padding in needle-punched, heat-set, sound absorbing felt and in expanded polyurethane. Covers: non-removable in 100% twisted viscose satin with anti-mite treatment Sanitized® or in removable antimicrobial fabric Amicor Pure™. h 160-180 / 6 1/4"-7".

Relax



Materasso a molle insacchettate singolarmente con imbottitura di irrigidimento in feltro agugliato, fonoassorbente e in poliuretano espanso. Rivestimenti: non sfoderabile in 100% raso viscosa ritorto con trattamento antiacaro Sanitized® o in tessuto sfoderabile antimicrobico Amicor Pure™. Mattress with individually pocket springs with stiffening padding in needle-punched, sound absorbing felt and in expanded polyurethane. Covers: non-removable in 100% twisted viscose satin with anti-mite treatment Sanitized® or in removable antimicrobial fabric Amicor Pure™. h 160-180 / 6 1/4"-7".

Benessere

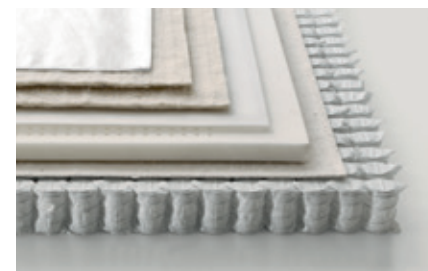

Materasso a molle rivestite singolarmente. Imbottitura di irrigidimento in feltro agugliato, fonoassorbente e in materiale viscoelastico forato indeformabile. Rivestimenti: non sfoderabile in 100% raso viscosa ritorto con trattamento antiacaro Sanitized® o in tessuto sfoderabile antimicrobico Amicor Pure™. Mattress with individually pocket springs. Stiffening padding in needle-punched, sound absorbing felt and in non-deformable perforated viscoelastic material. Covers: non-removable in 100% twisted viscose satin with anti-mite treatment Sanitized® or in removable antimicrobial fabric Amicor Pure™. h 180-200 / 7"-7 3/4".

Benessere Plus



Materasso a molle rivestite singolarmente. Imbottitura di irrigidimento in feltro agugliato, fonoassorbente e in materiale viscoelastico forato indeformabile. Rivestimento: tessuto sfoderabile antimicrobico Amicor Pure™. Mattress with individually pocket springs. Stiffening padding in needle-punched, sound absorbing felt and in non-deformable perforated viscoelastic material. Cover: removable antimicrobial fabric Amicor Pure™. h 240-250 / 9 1/2"-9 3/4".

Anatomico



Materasso a molle insacchettate con 7 zone di portanza differenziata. Imbottitura di irrigidimento in feltro agugliato, fonoassorbente e in poliuretano espanso. Rivestimenti: non sfoderabile in 100% raso viscosa ritorto con trattamento antiacaro Sanitized® o in tessuto sfoderabile antimicrobico Amicor Pure™. Mattress with pocket springs with 7-zone support. Stiffening padding in needle-punched, sound absorbing felt and in expanded polyurethane. Covers: non-removable in 100% twisted viscose satin with anti-mite treatment Sanitized® or in removable antimicrobial fabric Amicor Pure™. h 160-180 / 6 1/4"-7".

Luxor



Materasso a molle indipendenti inserite in singoli sacchetti in tessuto immarcescibile che evita la formazione di muffe e altri agenti patogeni. Imbottitura di irrigidimento in cotone e in poliuretano espanso. Rivestimento: non sfoderabile in 100% raso viscosa ritorto con trattamento antiacaro Sanitized®. Mattress with independent pocket springs in incorruptible fabric, which prevents the formation of moulds and other pathogens. Stiffening padding in cotton and in expanded polyurethane. Cover: non-removable in 100% twisted viscose satin with anti-mite treatment Sanitized®. h 240-250 / 9 1/2"-9 3/4".

Elite

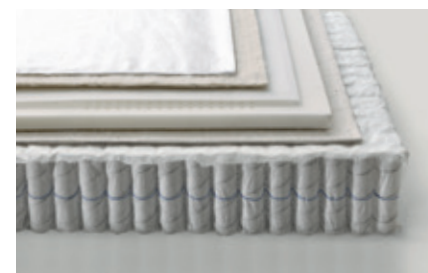

Materasso a molle rivestite singolarmente. Imbottitura di irrigidimento in feltro agugliato fonoassorbente e in materiale viscoelastico forato indeformabile. Rivestimento: non sfoderabile in 100% raso viscosa ritorto con trattamento antiacaro Sanitized®. Mattress with individually pocket springs. Stiffening padding in needle-punched, sound absorbing felt and in non-deformable perforated viscoelastic material. Cover: non-removable in 100% twisted viscose satin with anti-mite treatment Sanitized®. h 240-250 / 9 1/2"-9 3/4".

Elite Plus



Materasso a molle rivestite singolarmente. Imbottitura di irrigidimento in feltro agugliato fonoassorbente e in materiale viscoelastico forato indeformabile. Rivestimento: non sfoderabile in 100% raso viscosa ritorto con trattamento antiacaro Sanitized®. Mattress with individually pocket springs. Stiffening padding in needle-punched, sound absorbing felt and in non-deformable perforated viscoelastic material. Cover: non-removable in 100% twisted viscose satin with anti-mite treatment Sanitized®. h 240-250 / 9 1/2"-9 3/4".

Per rivestimenti, vedi pagina 320
For covers, see page 320

RIVESTIMENTI MATERASSI MATTRESS COVERS

La collezione Poliform prevede due tipologie di rivestimento per i materassi e due accessori dedicati a reti e materassi per garantire un riposo sempre più confortevole e personalizzato.

Poliform collection offers two cover typologies for the mattresses and two accessories for bedsteads and mattresses, ensuring a more comfortable and personalized rest.

Rivestimento Sanitized® Sanitized® cover



Rivestimento non sfoderabile in 100% raso viscosa ritorto di colore bianco con trattamento antiacaro Sanitized®, una fibra che possiede proprietà fungo-batteriostatiche e antiacaro. Imbottitura termica con lato estivo in cotone e lato invernale in lana. Lavorazione a trapunta con disegno a rombi stilizzati. Fascia perimetrale trapuntata con 4 maniglie in puro cotone.

Non-removable cover in 100% twisted viscose satin in white colour with anti-mite treatment Sanitized®, this fibre has bacteriostatic-antifungal properties and it is effective against mites. Thermal padding with summer side in cotton and winter side in wool. Quilted manufacturing with a stylized diamond pattern. Quilted perimeter band with 4 handles in pure cotton.

escluso materasso Benessere Plus / except mattress Benessere Plus

Rivestimento Amicor Pure™ Amicor Pure™ cover



Rivestimento sfoderabile in tessuto antimicrobico Amicor Pure™, una fibra che grazie ad un meccanismo di diffusione costante eroga un additivo sicuro per la pelle e l'ambiente, che elimina gli allergeni e i microbi che abitualmente si annidano nei materassi. Imbottitura 100% anallergica. Il rivestimento può essere lavato senza comprometterne l'effetto antimicrobico.

Removable cover in antimicrobial fabric Amicor Pure™, a fibre that, thanks to a slow spreading mechanism supplies a barely adequate quantity of a safe additive for both the skin and the environment. This substance eliminates allergens and microbes, which are usually in mattresses. Padding 100% anallergic. The antimicrobial effect is not eliminated by washing the cover.

escluso materassi Luxor, Elite, Elite Plus / except mattresses Luxor, Elite, Elite Plus

COPRIRETE E TOPPER BEDSTEAD COVER AND TOPPER

Coprirete Bedstead cover



Lato superiore in tessuto cotone/poliestere colore ardesia, imbottitura 100% poliesteri, lato inferiore in TNT nero. Lavorazione a trapunta con disegno a rombi stilizzati. Completo di 4 elastici negli angoli. Lavabile esclusivamente a secco.

Dimensioni mm: l 800-900-1000-1400-1600-1800-2000 x p 2000-2100.
Queen size l 1525 x p 2030.
King size l 1930 x p 2030.

Upper side in fabric cotton/polyester colour ardesia, padding 100% polyester, lower side in black non-woven fabric. Quilted manufacturing with a stylized diamond pattern. Complete with 4 elastic bands in the corners. Dry clean only.

Dimensions in: w 31 1/2"-35 1/2"-39 1/4"-55" 63"-70 3/4"-78 3/4" x d 78 3/4"-82 3/4".
Queen size w 60" x d 80".
King size w 76" x d 80".

disponibile solo per rete fissa / available only for fixed bedstead

Topper Topper



Non sfoderabile in tessuto 100% raso/viscosa ritorto, imbottitura in Policotton. Completo di 4 elastici negli angoli. Lavabile esclusivamente a secco.

Dimensioni mm: spessore 40, l 1600-1800-2000 p 2000-2100.
Queen size l 1525 x p 2030.
King size l 1930 x p 2030.

Non-removable cover in 100% satin/viscose twisted fabric, padding in Policotton. Complete with 4 elastic bands in the corners. Dry clean only.

Dimensions in: thickness 1 1/2", w 63"-70 3/4"-78 3/4" d 78 3/4"-82 3/4".
Queen size w 60" x d 80".
King size w 76" x d 80".

INSERTI GUANCIALE E RULLO PILLOW INSERTS AND ROLL-CUSHION

Dacron Dacron



Imbottitura 100% poliestere, fodera 100% cotone. Igienico, anallergico e di facile manutenzione. Offre una piacevole sensazione di soffici ta e comfort, adattandosi alla testa e al collo, tornando poi alla propria forma. Dimensioni mm: 500 x 800 - 500 x 900.
Padding in 100% polyester, cover in 100% cotton. Hygienic, anti-allergenic and easy to maintain. This pillow offers a pleasant sensation of softness and comfort, adapting to head and neck and returning to the original shape in a slow way. Dimensions in: 19 3/4" x 31 1/2" - 19 3/4" x 35 1/2".

Piuma d'oca Goose feathers



Imbottitura 70% piuma d'oca e 30% piuma d'anatra, fodera 100% cotone. Le alte capacit  traspiranti garantiscono una temperatura di riposo uniforme. Assorbe l'umidit  e favorisce l'evaporazione del calore in eccesso. Dimensioni mm: 500 x 800 - 500 x 900.
Padding in 70% goose feathers and 30% duck feathers, cover in 100% cotton. Thanks to the high ventilation temperature will remain static throughout the night. It absorbs humidity and lets exceeding heat evaporate. Dimensions in: 19 3/4" x 31 1/2" - 19 3/4" x 35 1/2".

Piumino d'oca Goose down



Imbottitura 20% piumino d'oca e 80% piuma d'oca, fodera 100% cotone. Le alte capacit  traspiranti garantiscono una temperatura di riposo uniforme. Assorbe l'umidit  e favorisce l'evaporazione del calore in eccesso. Dimensioni mm: 500 x 800 - 500 x 900.
Padding in 20% goose down and 80% goose feather, cover in 100% cotton. Thanks to the high ventilation temperature will remain static throughout the night. It absorbs humidity and lets exceeding heat evaporate. Dimensions in: 19 3/4" x 31 1/2" - 19 3/4" x 35 1/2".

Rullo Roll-cushion



Imbottitura 100% poliestere, fodera 100% cotone. Rivestimento finale sfoderabile in tessuto o pelle.
Disponibile in coppia per larghezze materasso 1600 1800-2000 e per le versioni Queen size e King size, Ø 150-180. Per letti Kelly e Park 1 consigliato Ø 150.
Padding in 100% polyester, cover in 100% cotton. Removable final cover in fabric or leather. Available in pair for mattresses width 63"-70 3/4"-78 3/4" and for the versions Queen size and King size, Ø 6"-7 3/4". For beds Kelly and Park 1 suggested Ø 6".

INSERTI PIUMINO DUVET INSERTS

Piuma Feather



Imbottitura 50% piumino d'oca e 50% piumetta d'oca, fodera 100% cotone. Disponibile per larghezze materasso 1000 (piumino l 1800), 1400-1600 (piumino l 2400), 1800-2000 (piumino l 2800) p 2000.
Padding in 50% goose down and 50% plumule of goose, cover in 100% cotton. Available for mattresses width 39 1/4" (duvet w 70 3/4"), 55"-63" (duvet w 94 1/2"), 70 3/4"-78 3/4" (duvet w 110 1/4") d 78 3/4".

Dacron Dacron



Imbottitura 100% poliestere, fodera 100% cotone. Disponibile per larghezze materasso 1000 (piumino l 1800), 1400-1600 (piumino l 2400), 1800-2000 (piumino l 2800) p 2000.
Padding in 100% polyester, cover in 100% cotton. Available for mattresses width 39 1/4" (duvet w 70 3/4"), 55"-63" (duvet w 94 1/2"), 70 3/4"-78 3/4" (duvet w 110 1/4") d 78 3/4".

Fiberfill doppia stagione Fiberfill "double season"



Imbottitura in fibra anallergica 100% poliestere, fodera 100% cotone. Formato da due inserti accoppiati ed utilizzabili separatamente.
Disponibile per larghezze materasso 1000 (piumino l 1800), 1400-1600 (piumino l 2400), 1800-2000 (piumino l 2800) p 2000.
Padding in non-allergenic fibre 100% polyester, cover in 100% cotton. Composed of two coupled inserts which can be used separately. Available for mattresses width 39 1/4" (duvet w 70 3/4"), 55"-63" (duvet w 94 1/2"), 70 3/4"-78 3/4" (duvet w 110 1/4") d 78 3/4".

COLLEZIONE BIANCHERIA
LINEN COLLECTION



Il progetto Poliform dedicato alla zona notte comprende una collezione di biancheria letto coordinata, in cotone Provence con una gamma di sette colori e profilo a "coda di topo" a contrasto o tono su tono.

Set estivo

2 federe, lenzuolo sotto, lenzuolo sopra.
Disponibile per larghezze materasso 1000-1400-1600-1800-2000 p 2000.

Set invernale

2 federe, lenzuolo sotto, copripiumino.
Disponibile per larghezze materasso 1000 1400-1600-1800-2000 p 2000.

Federe

Disponibili per guanciali 500 x 800 e 500 x 900.

Lenzuolo sotto/sopra

Disponibile per larghezze materasso 1000 1400-1600-1800-2000 p 2000.

Sacco copripiumino

Disponibile per larghezze materasso 1000 1400-1600-1800-2000 p 2000.

The Poliform project for the bed accessories includes a bed linen collection in cotton Provence available in seven colours with piping in contrast or matching colours.

Summer bed-set

2 pillow cases, fitted sheet, top sheet.
Available for mattresses width 39 1/4"-55" 63"-70 3/4"-78 3/4" d 78 3/4".

Winter bed-set

2 pillow cases, fitted sheet, duvet cover.
Available for mattresses width 39 1/4"-55" 63"-70 3/4"-78 3/4" d 78 3/4".

Pillow cases

Available for pillows 19 3/4" x 31 1/2" and 19 3/4" x 35 1/2".

Upper/lower sheet

Available for mattresses width 39 1/4"-55" 63"-70 3/4"-78 3/4" d 78 3/4".

Eiderdown cover

Available for mattresses width 39 1/4"-55" 63"-70 3/4"-78 3/4" d 78 3/4".

Provence coordinati letto
Bed linen Provence



01 bianco



02 panna

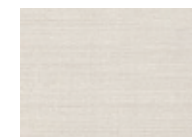

08 polvere



04 tortora



06 roccia



07 grafite

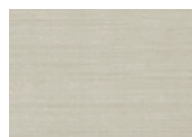

03 ghiaccio

COPERTA LINUS
LINUS BLANKET



La coperta Linus è in pura lana lavorata a nido d'ape, un motivo che le conferisce un aspetto materico e contemporaneo. Leggera ma calda, in versione copriletto o plaid, si abbina ai tessuti e alle pelli della collezione con una palette colori che comprende cinque varianti.

Plaid

Dimensioni mm: 1100 x 2400.

Copriletto

Dimensioni mm: 2200 x 2400.

The Linus blanket is made of pure honeycomb wool, a pattern that gives it a material and contemporary look. Light but warm, in the version bedcover or blanket, it is designed to match the fabrics and leathers of the collection and includes five colour variants.

Plaid

Dimensions in: 43 1/4" x 94 1/2".

Bedcover

Dimensions in: 86 1/2" x 94 1/2".



latte

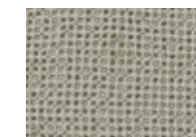

sabbia

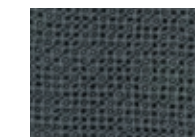

grafite



notte

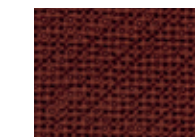

granata

TECHNICAL DATA

TAPPETI
CARPETS

328

FINITURE
FINISHINGS

334

INDICE PRODOTTI
PRODUCT INDEX

342

TAPPETI CARPETS

Relief

Prodotto a mano con tecnica handloom.
Trama in cotone, vello in lana himalayana
e seta di bambù, bouclé in lana himalayana.
Dimensioni mm: rettangolare 1700×2400
2300×3000 - 3000×4000
quadrato 3000×3000.

Handmade with the handloom technique.
Cotton weave, fleece in Hymalayan wool
and bamboo silk, Hymalayan wool bouclé.
Dimensions in: rectangular 67"x94 1/2"
90 1/2"x118" - 118"x157 1/2"
square 118"x118".



Perla



Cammello

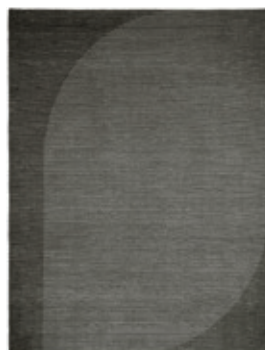

Tortora

Cannelé

Prodotto a mano con tecnica handloom.
Trama in cotone, vello in lana himalayana
e seta di bambù, bouclé in lana himalayana.
Dimensioni mm: rettangolare 1700×2400
2300×3000 - 3000×4000
quadrato 3000×3000.

Handmade with the handloom technique.
Cotton weave, fleece in Hymalayan wool
and bamboo silk, Hymalayan wool bouclé.
Dimensions in: rectangular 67"x94 1/2"
90 1/2"x118" - 118"x157 1/2"
square 118"x118".



Tratto

Prodotto a mano con tecnica handloom.
Trama in cotone, vello in lana himalayana
e seta di bambù.
Dimensioni mm: rettangolare 1700×2400
2300×3000 - 3000×4000
quadrato 3000×3000.

Handmade with the handloom technique.
Cotton weave, fleece in Hymalayan wool
and bamboo silk.
Dimensions in: rectangular 67"x94 1/2"
90 1/2"x118" - 118"x157 1/2"
square 118"x118".



Ruggine



Carbone



Tortora

TAPPETI
CARPETS

Frame

Prodotto a mano con tecnica handloom.
Trama in cotone, vello in seta di bambù.
Bordo perimetrale di 80 mm in lana
himalayana in tinta solo per la versione
rettangolare.
Dimensioni mm: rettangolare 1700x2400
2300x3000 - 3000x4000
quadrato 3000x3000 - ovale 2300x4000.

Handmade with the handloom technique.
Cotton weave, fleece in bamboo silk.
80 mm - 3 1/4" perimeter edge in Himalayan
wool in matching colour only for the
rectangular version.
Dimensions inches: rectangular 67"x94 1/2"
90 1/2"x118" - 118"x157 1/2"
square 118"x118" - oval 90 1/2"x157 1/2".



Grey



Gold



Perla



Carbone



Plain

Prodotto a mano con tecnica handloom.
Trama in cotone, vello in aloe e seta di bambù.
Nella versione rettangolare fascia di
150 mm in tonalità più scura sul lato superiore
e inferiore e di 100 mm per la dimensione
1700x2400. Nella versione tonda la parte più
scura è di 1/4 del tappeto.
Dimensioni mm: rettangolare 1700x2400
2300x3000 - 3000x4000
quadrato 3000x3000 - rotondo Ø 2500.

Handmade with the handloom technique.
Cotton weave, fleece in aloe and bamboo silk.
Rectangular version 6" band in darker colour
in the upper and lower side and 4" band for
the size 67"x94 1/2".
In the round version the darkest part is
1/4 of the carpet.
Dimensions inches: rectangular 67"x94 1/2"
90 1/2"x118" - 118"x157 1/2"
square 118"x118" - round Ø 94 1/2".



Tortora

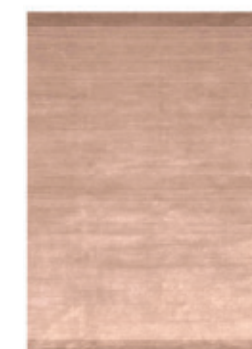
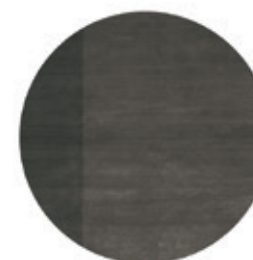

Cipria

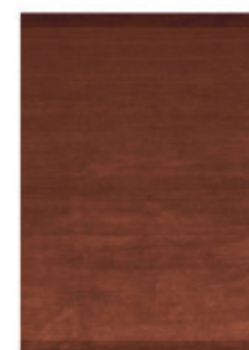
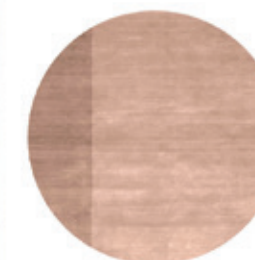

Ruggine



Arena

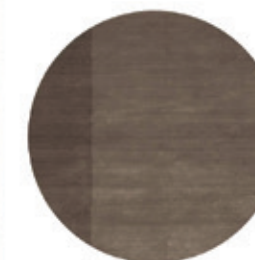

Natural



TAPPETI CARPETS

Dama

Prodotto a mano con tecnica handloom.
Trama in cotone, vello in lana himalayana e seta di bambù.
Dimensioni mm: rettangolare 1100×3500
1700×2400 - 2300×3000 - 3000×4000
quadrato 3000×3000.



Handmade with the handloom technique.
Cotton weave, fleece in Hymalayan wool and bamboo silk.
Dimensions inches: rectangular 43 1/4"x137 1/4" - 67"x94 1/2" - 90 1/2"x118" - 118"x157 1/2" square 118"x118".

Stripes

Prodotto a mano con tecnica handloom.
Trama in cotone, vello in lana himalayana e seta di bambù.
Dimensioni mm: rettangolare 1100×3500
1700×2400 - 2300×3000 - 3000×4000
quadrato 3000×3000.



Handmade with the handloom technique.
Cotton weave, fleece in Hymalayan wool and bamboo silk.
Dimensions inches: rectangular 43 1/4"x137 1/4" - 67"x94 1/2" - 90 1/2"x118" - 118"x157 1/2" square 118"x118".

Soft

Prodotto a mano con tecnica handloom.
Trama in cotone, vello in seta di bambù grigio sfumato.
Dimensioni mm: rettangolare 1700×2400
2300×3000 - 3000×4000
quadrato 3000×3000.

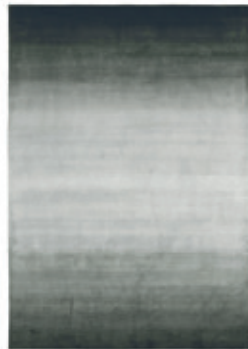

Handmade with the handloom technique.
Cotton weave, fleece in bamboo silk shaded grey.
Dimensions inches: rectangular 67"x94 1/2" - 90 1/2"x118" - 118"x157 1/2" square 118"x118".

FINITURE
FINISHINGS

Laccato opaco
Mat lacquer



Laccato lucido
Glossy lacquer

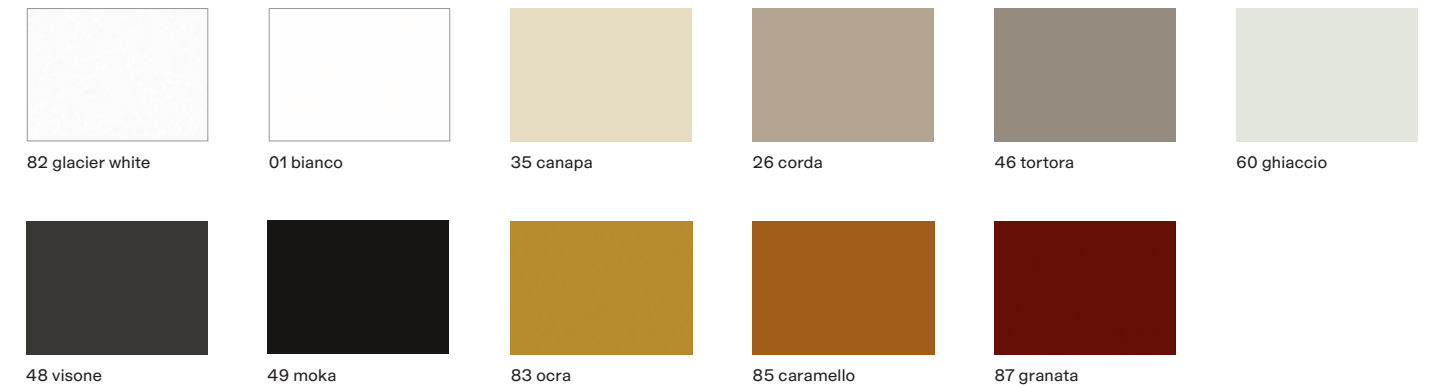

Laccato antigraffio
Antiscratch lacquer

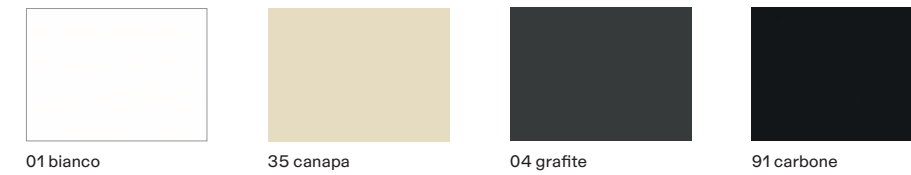

Laccato metallico
Metallic lacquer



FINITURE
FINISHINGS

**Essenza
Wood**



rovere gold
gold oak



rovere spessart
spessart oak



noce gold
gold walnut



olmo nero
black elm

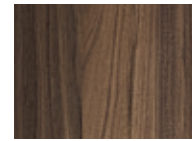

massello noce canaletto
solid walnut canaletto



cedro
cedar

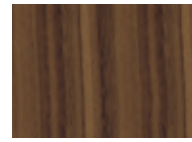

noce
walnut

**Cuoio
Hide**



28 avorio



29 tortora



19 caffè



38 oliva



15 prugna



26 invecchiato



03 grigio scuro



02 nero

**Tecnocover Grain
Grain tecnocover**

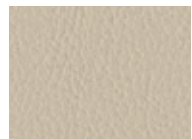

05 latte

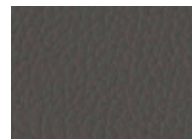

01 elefante



02 moro



06 nocciola

**Tessuto
Fabric**

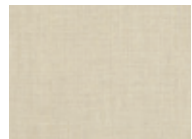

lino chiaro

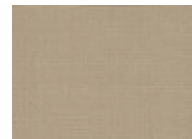

lino é cru

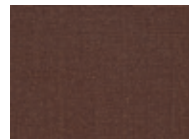

lino bruciato



lino scuro

**Marmo levigato
Mat marble**



bianco carrara



calacatta oro



verde lepanto

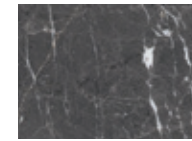

grigio stardust

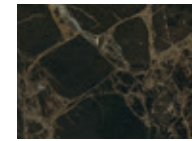

emperador dark

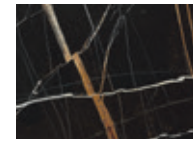

sahara noir
finitura poliestere
polyester finish



zecevo

**Marmo lucido
Glossy marble**



bianco carrara



calacatta oro



verde lepanto

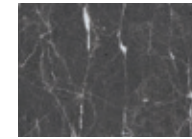

grigio stardust

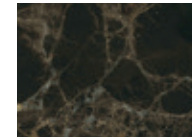

emperador dark

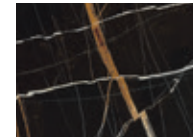

sahara noir
finitura poliestere
polyester finish



noir saint laurent

**Gabbro
Gabbro**

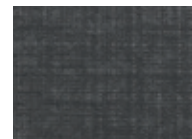

nero assoluto
texture juta

**Onice
Onyx**



ambra
amber

**Semiprezioso
Semiprecious stone**



lapislazzulo blu
blue lapis lazuli

**Pietra spatolata
Spatula-finish stone**

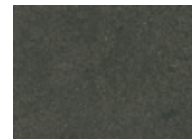

ebano
ebony

**Grès porcellanato lucido
Glossy gres porcelain**

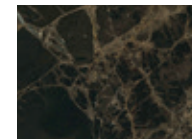

emperador dark



calacatta oro

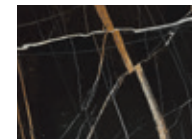

sahara noir

FINITURE FINISHINGS

Tessuti Fabrics



Pelle Leather



Pelliccia Cashmere Cashmere fur

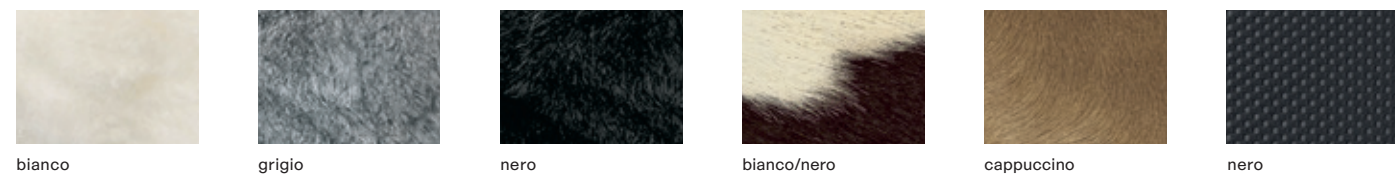

Pelle Hairy Hairy leather

Tecnocover Pixel Pixel tecnocover

Bordura gros-grain - bordura in seta - filati Grosgrain border - silk border - yarns



Provence coordinati letto Bed linen Provence

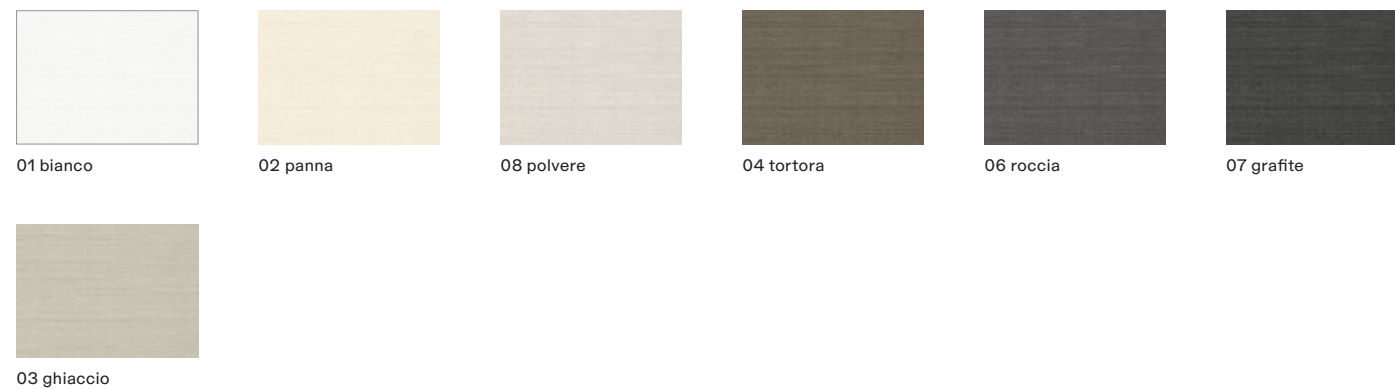

LETTI
BEDS



Gentleman, design Marcel Wanders studio
pp. 10-25



Kelly, design Emmanuel Gallina
pp. 26-45



Park 1, design Carlo Colombo
pp. 46-61



Rever, design Rodolfo Dordoni
pp. 62-75



Dream, design Marcel Wanders studio
pp. 76-95



Jacqueline, design Jean-Marie Massaud
pp. 96-119



Chloe, design Carlo Colombo
pp. 120-133



Arca, design R&D Poliform
pp. 134-149



Onda, design Paolo Piva
pp. 150-165

CONTENITORI
STORAGE UNITS



Gentleman, design Marcel Wanders studio
pp. 170-185



Kelly, design Emmanuel Gallina
pp. 186-201



Onda, design R&D Poliform
pp. 202-215



Abbinabili, design R&D Poliform
pp. 216-229



Dream, design Marcel Wanders studio
pp. 230-243



Chloe, design Carlo Colombo
pp. 244-255



You, design D&T
pp. 256-269

SPECCHI
MIRRORS



Drop, design R&D Poliform
pp. 274-283



Circle, design R&D Poliform
pp. 284-293



Audrey, design Emmanuel Gallina
pp. 294-303



Sara, design Flaviano Capriotti
pp. 304-313

Poliform Spa
via Montesanto 28
Casella postale n. 1
22044 Inverigo (CO) Italy
t +39 031 6951
f +39 031 699444
info@poliform.it
poliform.it



2018 Adi Compasso D'oro
Career Award

Poliform realizza tutte le sue collezioni in Italia usando componenti e materie prime selezionate.

All the Poliform collections are manufactured 100% in Italy using top-class components and materials.

Poliform si riserva il diritto di apportare, senza preavviso, ogni modifica mirata al miglioramento funzionale e qualitativo dei propri prodotti. Testi e disegni presenti in questo stampato hanno scopo divulgativo: per ogni aspetto tecnico e dimensionale fare riferimento ai listini aziendali e relativi aggiornamenti. I campioni di colori e materiali hanno valore indicativo.

Poliform reserves the rights at all time to apply modifications for the functional or qualitative improvement of its products. Texts and drawings present in this brochure have a divulgative purpose: for every technical and dimensional aspect please refer to the company's price lists and their relative updates. The colour and material samples have an indicative value.

Creative Direction
Apartamento Studios

Graphic Design
Apartamento Studios

Interiors Photography
Federico Cedrone, Omar Sartor

Still Life Photography
Silvia Orlandi

Interiors Styling
Poliform Lab

1st edition February 2022
cod. 126/R1/2022



POLIFORM.COM